

SHIMANO

Dealer Catalogue 2021





WELCOME

Dear Business Partner,

I would personally like to welcome you to our 2021 Dealer Catalogue. For dealers who don't know me, I have been with SHIMANO for 33 years and for most of that time I have worked for the fishing division. I also spent seven years (1999 -2006) at the former SEFH headquarters in Nunspeet, the Netherlands, where I made many friends and business partners throughout Europe. During my time with the company I have seen many changes, but one thing that remains consistent at SHIMANO is the family-like, team attitude of the employees and the dealers. There is one thing for sure, we are all stronger as a unit, than we are as individuals, and I hope to develop this unity further and give you the confidence to push your business forward with security, enthusiasm and passion.

I also extend a warm welcome to our new regional offices in France, Spain, Portugal, Switzerland, Nordic, and the Baltic regions. These new offices further strengthen our European Team and will offer dealers of these countries a more comprehensive, personal service than previously experienced.

The Covid 19 pandemic created some tough business challenges, especially during the second quarter of 2020, when movement restrictions and social distancing were implemented across much of Europe. However, at the time of writing, it is hoped the worst is now behind us and in many countries trade has recovered remarkably well. One of the noticeable developments during this difficult period was the advantage of the MySHIMANO online portal. For those not familiar with the system, it is available to all partnering dealers and enables remote direct ordering, up to date product inventory and availability, along with a full range of supporting features. Further information can be accessed from your local SHIMANO office.

As always, at the heart of SHIMANO is the product range and the resulting pleasure it gives to anglers of all abilities. Our reputation of prestige, excellence and innovation is enhanced this year with the world-wide introduction of the award winning Vanford (ICAST USA July 2020), a reel which enables even more anglers to experience the benefits of the Magnumlite Series. There are also strategic introductions in many other reel areas, including the increasingly popular baitcasting and saltwater spinning disciplines. You will also see that the use of exclusive SHIMANO carbon technology (Spiral X Core, Spiral X, Hi-Power X is now being used in a wider variety of rods, which again reinforces our commitment to making products which enhance the fishing experience and increase enjoyment. One last new introduction needs mentioning, the new Kairiki 4 carrier braided line! This line oozes quality at a really competitive price point! Further introduction of captivating new products will be launched continuously throughout the later part of 2020 and into 2021 to ensure you have maximum opportunity to create additional revenue.

Finally, I would like to thank all of you for your continued support of SHIMANO. You are an integral and very important part of our business and I wish you all the best during the following year.

Akira Koshimizu

Managing Director - SHIMANO Europe Fishing Division

CONTENTS

REELS

8	FRONT DRAG
27	REAR DRAG
31	BIG PIT
45	BAITRUNNER
53	BAITCASTING
73	SALTWATER
81	MULTIPLIER
90	ELECTRIC

RODS

104	SPINNING
139	TROUT
145	CATFISH
149	S.T.C.
155	SPECIMEN
165	MATCH & FEEDER
177	TELESCOPIC
183	SALTWATER SPINNING
201	BOAT
215	SURF

ACCESSORIES

222	LUGGAGE
243	LINE
253	CLOTHING · EYEWEAR
258	LURES
281	ISOLATE BAIT
288	REEL MAINTENANCE

SPECIFICATION INFO

CoreSolid Series - CoreSolid is the name for spinning reels with a 'silky feeling' and characteristics of high rigidity and high power.

Magnumlite Series - Magnumlite is the name for spinning reels with a 'light start-up' and characteristics of low weight and low inertia.

Reel Size - Spinning reels are available in various sizes: 500, 750, 1000, 2000, 2500, 3000, 4000, 5000, 6000 - and beyond. The number indicates the line capacity: a 1000 sized spool contains less line than a 3000 sized spool. However, the bigger the line capacity of the reel, the bigger all the other components of the reel are as well. So in total, a size 3000 reel is bigger than a size 1000. The right size of the reel for a fisherman depends strongly on the rod used (length, casting weight), the way of fishing and personal preference.

Gear Ratio - The Gear Ratio of the reel indicates the speed of the reel. This is showed in a number which includes the amount of turns of the rotor (360 degrees) in one full rotation of the handle. Example: In a reel with a gear ratio of 6.0:1 the rotor rotates exactly 6.0 times in one handle rotation. A reel with a high gear ratio (HG or XG) is faster, which is an advantage when you need a fast retrieve speed. A reel with a low gear ratio is slower and because of that more powerful. A low gear ratio is an advantage when heavy bait / lead / lures are used, a high gear ratio is an advantage when speed is required.

Anti-Reverse - This feature allows the angler to disengage the anti-reverse function enabling the reel to be cranked backwards. The reverse option of the reel is useful for quick and smooth line release without opening the bail or need to pull line while using the drag. It's not standard on every spinning reel anymore (it used to be integrated in all of them), because this feature has one disadvantage - the lever needs a small opening in the reel body. Removing the function means the lever is not necessary anymore and that means one opening less in the reel body. This is an advantage for the durability of the reel, because water and dirt can't enter the inner parts of the reel via this opening anymore.

Spool Capacity - The spool capacity indicates how much line can be spooled on the reel spool. This is often communicated in line diameter (mm) – meters and line strength (lb) – yards.

Maximum Drag Force - The maximum drag force is a number in kg / lb, which shows the maximum tension of the drag. For example, when the maximum drag force of a reel is 6kg, 6 kilogram or more of pressure needed before the drag starts to give line when it is fully closed.

Line Retrieve per Crank - The 'Line retrieve per crank / handle turn' specification explains how much line is retrieved in one full crank with the reel handle. This is measured in centimetres. This indicates the retrieving speed of the reel. A fast retrieving reel is often wanted by lure anglers, because they can retrieve their lure very quickly. Generally: the bigger the spool size, the more line retrieved per crank. The same goes for the gear ratio: the faster the gearing (a higher gear ratio) means more line retrieved per crank when compared to a reel with a lower gearing.

SHIMANO MATERIAL INFO

XT-7 - XT-7 is the original SHIMANO composite reel material, used on reel bodies and spools. XT-7 is reliable, robust and lightweight.

XGT-7 - XGT7 SHIMANO Graphite is stronger than normal used material. It's developed using the latest technology for improved rigidity and longevity.

Ci4+ - SHIMANO's Ci4+ is a composite (composite = two or more raw materials used) material with very special characteristics and is actually stronger than the original Ci4 material. Since Ci4+ does not contain any metal, so it is impervious to rust. Ci4+ parts are lighter and stronger than any other composite material SHIMANO is using in their products.

Magnesium - Magnesium is used by SHIMANO for a select number of ultra high quality reels where weight saving is essential. The use of magnesium offers a weight reduction up to 10% compared to aluminium and can cope with both lightweight and high rigidity.

Cold Forged Aluminium - Cold Forging means forging aluminium at a temperature of 21 degrees Celsius. Very heavy pressure is used to forge the aluminium or magnesium into it's shape and this technology results in super strong and rigid reel parts. The commercial name of this technology which is used by SHIMANO is HAGANE.

SHIMANO GEARING TECHNOLOGY

HAGANE Gear - The HAGANE Drive Gear is produced by SHIMANO's cold forging technology, without the need for additional machining. This results in gearing parts which retain the characteristics of the pure material, keeping it as strong as possible.

Micro Module Gear II - a further advanced through state-of-the-art, gear tooth surface design and SHIMANO's exclusive manufacturing technology. The surface of the drive gear and pinion gear have been analysed and updated from the ground up in pursuit of perfection. Starting from an already industry leading standard, reduced reel noise and even smoother gear feeling have been realised.

X-SHIP - X-SHIP stands for Extra Smooth & High Power. It is a precision gearing system which enables smooth yet strong reeling. By supporting the pinion gear on both ends with bearings and integrating a bigger drive gear with improved position, SHIMANO have increased the gearing efficiency and power of reels with the X-SHIP feature. It results in a reel with ultra-light handle rotation which is very powerful at the same time.

InfinityDrive - InfinityDrive uses a special low-friction bush to greatly reduce sliding resistance of the main shaft. This achieves a reduction in rotational resistance for easier, smoother winding.

SilentDrive - SilentDrive is a total redesign of 11 internal components with the result of reducing microscopic handle play eliminating noise and unnatural feeling from the worm shaft. The combination of the redesigned components and extremely fine tolerance engineering produces silent and super smooth reeling, even when under pressure.

SHIMANO BALLBEARING TECHNOLOGY

A-RB - SHIMANO Stainless Steel Anti-Rust Bearings have undergone a special heat treatment resulting in high metal strength and long lasting corrosion resistance.

(S) A-RB - Shielded Stainless Steel Anti-Rust Bearings. These bearings have undergone a special heat treatment resulting in high metal strength. Shielded A-RB bearings use either a rubber shield or stainless steel shield (depending on bearing size) for the ultimate in corrosion resistance and contaminant protection against sand, salt or dust.

SHIMANO SPOOL TECHNOLOGIES

AR-C Spool - AR-C is a spool-lip design technology by SHIMANO. Through tens of thousands of casting tests and computer simulations, it has been determined that the AR-C spool lip design provides longer casting distances than a standard spool lip design, while preventing backlashes and wind knots. It also allows the line to flow off the spool in smaller loops during the cast which means less line slap on the first guide.

Long Stroke Spool - Increases the casting distance. This feature can be found on many of the new front drag reels in the CoreSolid and Magnumlite series and is very noticeable when using small 'finesse' type lures.

Barrier Coat Spool - improves protection to corrosion, therefore, improving durability.

Cold Forged Alu - The spool is made from cold forged aluminium. This process creates a lightweight result with increased structural strength and more resistance to abrasion and damage.

Magnumlite - Magnumlite is a revolutionary cold forged lightweight aluminium used to construct our light weight baitcasting spools.

SHIMANO BODY TECHNOLOGIES

HAGANE Body - A reel with HAGANE Body has a body made out of precision machined cold-forged aluminium or magnesium. The creates stiffness and impact resistance, why at the same time eliminating flexing of the body. The HAGANE Body is highly rigid and protects gear rotation performance from heavy loads and shocks.

G Free Body - G Free Body technology has been developed to shift the reel's center of gravity closer to the rod. This has been achieved by moving the oscillation mechanism more towards the top of the reel. By moving the centre of gravity closer to the angler's hand position, the G Free Body helps to reduce fatigue and enhance casting comfort.

Parallel Body - Parallel Body is a feature that is designed to improve dynamic line flow from the reel to the first guide. On many reels the spool is aligned slightly upwards towards the rod blank, but with Parallel Body it is at exactly 90° to the blank. The result is less line slap the blank as it travels towards the first guide during casting.



SHIMANO ROTOR TECHNOLOGIES

Magnumlite (MGL) Rotor - The Magnumlite Rotor is an ultra-light improved rotor made out of C14+ material. The profile of the rotor is made asymmetrical and the bail arm mechanism, which is usually situated on the same side as the line roller, has been moved to the opposite side. Both of these changes improve the balance. The rotor rigidity at the line roller side has been improved which reduces the deflection under maximum pressure by up to 30%. Also the line roller is made of lightweight material, the bail is made from titanium and the rotor thickness has been optimized. All of this results in a lighter rotor, improved balance and is saving a 14% in rotation inertia.

X Rigid Rotor - SHIMANO's X Rigid Rotor is an extra strong and durable rotor. The shape and thickness of the aluminium rotor creates high rigidity that results in more fish fighting power. Increased mass of the aluminium rotor generates more inertia resulting in easier fishing of heavy jigs and high resistance lures.

Aero Wrap - Aero Wrap is a worm gear oscillation system with a specially designed pitch to create optimal oscillation speeds for the AR-C spool design. The one speed oscillation system provides a line lay with one speed (the same speed upwards and downwards). The two-speed oscillation system (the spool moves upward quickly and downwards slowly) layers the line onto the spool in a precise criss-cross pattern that reduces line-to-line friction when casting.

Varispeed II - Varispeed II takes care of a consistent spool speed, which is achieved by altering the speed of the oscillation cam. This is done by an oval gearing instead of a wormshaft.

One Piece Bail - One Piece Bail is a bail made of one piece of material, which allows the line to slide very smoothly over the bail to the line roller. Its seamless design reduces friction and reduces the chance of tangles or cuts to the bail arm.

SHIMANO DRAG TECHNOLOGIES

X-Tough Drag - X-Tough Drag incorporates large diameter drag washers at the base of the spool, which provide greater drag stability. The result is smooth and consistent drag performance throughout the fight. The Coil Wave Spring features steady elasticity at any compression level, and little deformation under repeated compression.

Heat Sink Drag - Heatsink drag improves performance by transferring heat away from the spool, reducing spool surface temperature by up to 100 degrees.

Rigid Support Drag - When hooking a large fish, the smoothness of the initial movement of the drag is the most important to avoid line break. By supporting the spool with the main shaft and two bearing links in the spool, it is possible to suppress the spool's flutter and to provide stable and smooth drag performance.

Rapid Fire Drag - Rapid Fire Drag is a drag system which is very precise and fast at the same time. It enables adjustment of the drag from heavy to light settings (and vice-versa) in only half a turn of the drag knob. Other reels sometimes require 1 or 2 full turns to do this. At the same time the different drag settings are very detailed, so the angler is able to adjust the drag to exactly the right settings.

Cross Carbon Drag - This carbon drag material provides a wider range of drag settings, along with the smoothest SHIMANO drag performance ever.

Waterproof Drag - The Waterproof Drag contains rubber gaskets which are placed to protect the drag system. It seals the drag against intrusion of the elements such as water and dust.

WATER RESISTANT TECHNOLOGIES

X-Protect - X-Protect is a three-lipped rubber seal system which is designed to keep low pressure water out of the reel. The grease between the second and third lips resists high pressure water. Besides the rubber seals, a labyrinth construction is added in order to make it waterproof for a much longer time. All of this does not effect the smooth rotor rotation or line roller performance.

X-Shield - By placing sealing gaskets in 12 critical locations throughout the rigid aluminium body, SHIMANO is able to create a water resistant structure that can hold up against the toughest conditions.

CoreProtect - CoreProtect is a SHIMANO technology which is developed to keep water out of the reel, without creating a heavier rotation feeling. This innovation is used in three areas of the reel:

- The Drag Area.** This is the most critical area when comes to balancing water resistance without affecting the light and smooth rotation of the reel. A surface protection coating causes water to bead. This beading action prevents water from flowing into the small crevices.
- The Body Area:** To protect the body, CoreProtect utilizes a series of 12 different seals and a flat body joint with surface treatment. The anti-reverse switch has also been removed from the body.
- The Line Roller:** A line roller with CoreProtect has a sealed one-piece design that provides water resistance and low maintenance. The sealed design does not require oil as part of regular maintenance.

REELS SPECIFICATION EXPLANATION

Product Code - The product code is used by all SHIMANO dealers to identify the model. The number (1000) indicates the reel size.

Weight - The weight indicates the weight of the reel in grams

Gear Ratio - The gear ratio is the amount of turns the spool rotor makes for one turn of the handle.

Line Capacity - The line capacity of the spool is shown in diameter (mm) and length (metres).

Product Code	Weight (g)	Gear Ratio	Line Capacity (mm/m)	Line Retrieve (cm)	Maximum Drag (kg)	Spare Spool Code
STL1000FJ	170	5.1:1	0.18mm-170m	64	3	RD18877
STL2500FJ	205	5.3:1	0.18mm-290m	78	9	RD18712

Line Retrieve - The line retrieve indicates the length of line in cm retrieved for one turn of the handle.

Maximum Drag - The maximum drag indicates the maximum power in kilos that the drag can be set to.

Spare Spool - Many reels come with spare spools. The spare spool column indicates how many spare spools.



HAGANE

HAGANE

OUR GOAL, ETERNALLY SMOOTH REELING

REEL MANUFACTURING BASED ON THE HAGANE CONCEPT IS SUPPORTED BY THE UNIQUE METALWORKING TECHNOLOGY THAT SHIMANO HAS DEVELOPED OVER THE YEARS.



STRENGTH

HAGANE GEAR is produced using SHIMANO's cold forging technology, without any additional machining. This retains the Integrity and strength of the material.



SMOOTH

MICROMODULE II GEAR is an improved version with even smoother performance. Super-refined teeth provide ultra smooth transmission.



POWER

X-SHIP is a two point pinion gear support which creates a **STRONG** Gearing foundation and maximises power transmission from the handle to the rotor.



RIGIDITY

The highly rigid **HAGANE BODY** protects the gear's rotation performance from heavy load and shock.

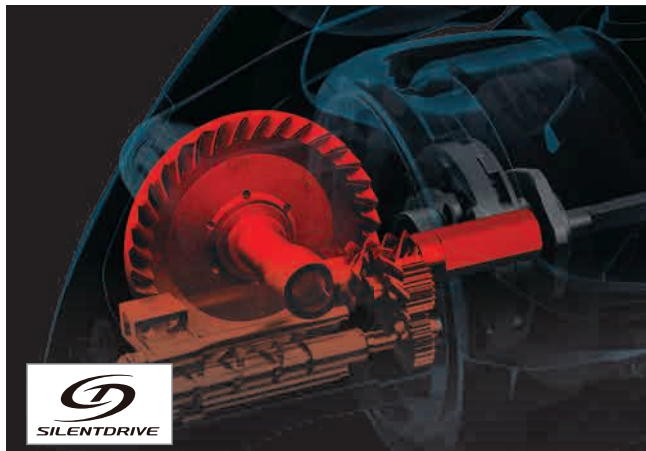

SILENDRIVE

SILENDRIVE is a total redesign of 11 internal components with the result of reducing microscopic handle play and eliminating noise and any unnatural feeling from the worm shaft. The combination of the redesigned components and extremely fine tolerance engineering produces silent and super smooth reeling, even when under pressure.

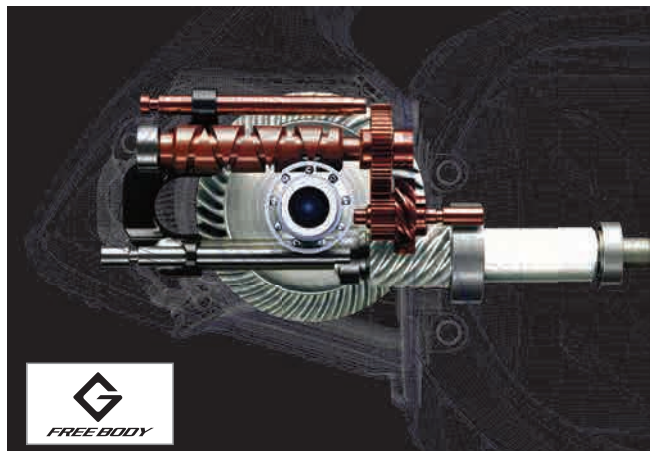

G FREE BODY

Developed to shift the reel's centre of gravity closer to the rod. This has been achieved by moving the worm shaft oscillation mechanism 19mm from the bottom of the reel to the top. By moving the centre of gravity closer to the anglers hand position, the **G FREE BODY** helps to reduce fatigue and enhance casting comfort.



WATER RESISTANT PROTECTION

FISHING ADVANTAGES

X-PROTECT Prevents water getting into the roller clutch without increasing friction. This improves rotational smoothness and increases the reels durability.

TECHNOLOGY

X-PROTECT is a triple lip structure Protecting the roller clutch. filled with special grease, friction is reduced and high waterproof performance is realised without losing smooth rotation performance.



AR-C SPOOL

AR-C is a spool-lip design technology by SHIMANO. Through tens of thousands of casting tests and computer simulations, it has been determined that the AR-C spool lip design provides longer casting distances than a standard spool lip design, while preventing backlashes and wind knots. It also allows the line to flow off the spool in smaller loops during the cast which means less line slap on the first guide.

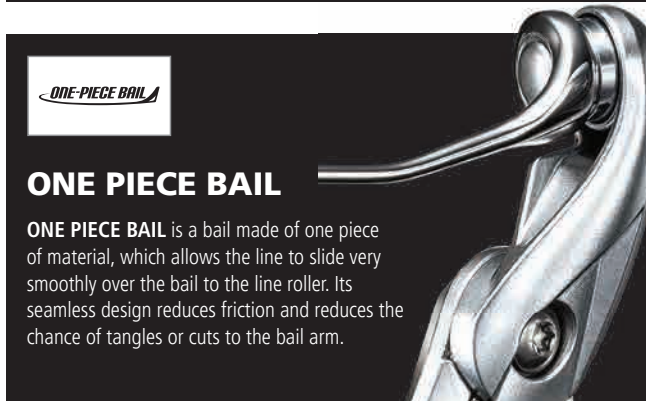

ONE PIECE BAIL

ONE PIECE BAIL is a bail made of one piece of material, which allows the line to slide very smoothly over the bail to the line roller. Its seamless design reduces friction and reduces the chance of tangles or cuts to the bail arm.



RIGID SUPPORT DRAG

When hooking a large fish, the smoothness of the initial movement of the drag is the most important to avoid line break. By supporting the spool with the main shaft and two bearing links in the spool, it is possible to suppress the spool's flutter and to provide stable and smooth drag performance.



REEL TECHNOLOGY

FRONT DRAG REELS

REAR DRAG REELS

BIG PIT REELS

BAITRUNNER REELS

BAITCASTING REELS

SALTWATER REELS

MULTIPLIERS



FRONT DRAG REELS

SHIMANO front drag reel design continually evolves, with new and improved technologies being introduced on a yearly cycle.

The STELLA FJ is the ultimate evolution of this, with additional features like improved HAGANE gearing, MicroModule II, SilentDrive and a new coil drag system. The result is the best reel SHIMANO has ever produced.

At the other end of the front drag reel range is the FX, a reel that offers exciting looks, excellent SHIMANO design and engineering and outstanding value for money.

Whichever front drag reel you are selling, you can be assured that for quality, value for money and customer experience, SHIMANO leads the way.



CORESOLID

- 12 STELLA
- 14 TWINPOWER
- 15 STRADIC
- 16 SOARE BB
- 17 SEPHIA BB · ULTEGRA

MGL

- 18 VANQUISH
- 19 EXSENCE
- 20 TWINPOWER XD · SUSTAIN
- 21 SUSTAIN · CARDIFF C14+
- 22 VANFORD

SPINNING

- 24 NASCI · SAHARA
- 25 SEDONA · NEXAVE · CATANA
- 26 ALIVIO · SIENNA · FX



METAL ROTOR



IMPROVED DRAG PERFORMANCE, A SOLID ROTOR THROUGH & THROUGH

METAL ROTOR Experience the featherweight rigid metal rotor made from Aluminium and Mangesium alloys. The high rigidity of the rotor will allow you to fish at ease without worries of distortion. Sturdy yet light, the reeling motion will feel unimaginably smooth.

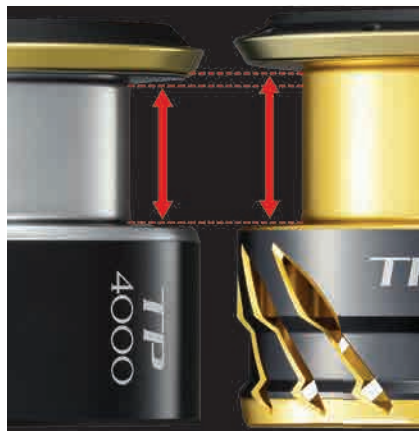

LONG STROKE SPOOL

LONG STROKE SPOOL

LONG STROKE SPOOL increases the casting distance. This feature can be found on many of the new front drag reels in the CoreSolid and Magnumlite series and is very noticeable when using small 'finesse' type lures.



MAGNUMLITE ROTOR

DESIGN EVOLUTION DELIVERS A NEW LEVEL OF LIGHTWEIGHT PERFORMANCE

**ROTATION INERTIA REDUCED BY 14%
LIGHTWEIGHT HAS BECOME EVER SHARPER.**

Redesigned Magnumlite Rotor now has the bail arm mechanism on the opposite side to the line roller for improved balance and lighter overall weight.

STIFF AND STRONG ROTOR RIGIDITY IMPROVED BY UP TO 30%.

The rotor rigidity on line roller side is also an important factor, which can effect drag performance. The newly developed Magnumlite Rotor offers excellent rigidity with up to 30% less deflection under maximum pressure.

CORESOLID

MGL MAGNUMLITE



CORESOLID SERIES

SPINNING REELS WITH SMOOTH, POWERFUL, EFFICIENT ROTATION AND ADVANCED WATERPROOF PROTECTION

The CoreSolid series feature a range of technologies to produce smooth, powerful, efficient rotation and advanced waterproof protection. All models in the series have HAGANE Gear and X-SHIP at the core of their gearing system, lightweight metal rotors for strength, plus advanced waterproof protection using X-Protect or Coreprotect.

The result is a range of reels that will excel in the most demanding conditions and situations.



MAGNUMLITE SERIES

SPINNING REELS WITH LIGHTWEIGHT, LOW INERTIA START-UP ROTATION FOR PRECISE CONTROL

All reels in the Magnumlite series feature the exclusive MGL Rotor, made from exclusive Ci4+ material, which offers ultra lightweight rotation. This enables more precision to be imparted on lure movements, especially when using lightweight, finesse lures and techniques.

As a guide, Magnumlite Series reels are generally lighter in weight, for their given size, which also enhances the lightweight experience.



ULTIMATE EVOLUTION

STELLA

- The flagship front drag reel for both fresh and saltwater conditions
- Combines the latest SHIMANO technologies in a magnesium body ensures maximum strength and durability at a minimum weight
- MicroModule II gearing and SilentDrive technology takes reel smoothness to a next level
- Small size 1000 ideal for targeting perch, zander and light rock fish
- Medium sizes 2500/3000 ideal for all round predator angling
- Bigger sizes 4000/5000 are perfect for fishing for the biggest of fresh water predators as well for inshore fishing for any species like seabass, blue fish and sea trout

SIZES: 1000, 2500, 3000, 4000, 5000

BEARINGS: 12 + 1

OSCILLATION: Aero Wrap

HANDLE: Screw in Single Aluminium

WATERPROOF DRAG: Yes



	Weight (g)	Gear Ratio	Line Capacity (mm-m)	Retrieval (m/min)	Spool Type	Spool Size (mm)	Line Length (m)
STL1000FJ	170	5.1:1	0.18mm-170m	64	3	RD18877	
STL2500FJ	205	5.3:1	0.18mm-290m	78	9	RD18712	
STL2500HGFJ	205	6.0:1	0.18mm-290m	89	9	RD18765	
STL2500SHGFJ	205	6.1:1	0.16mm-150m	89	4	RD18772	
STLC3000FJ	210	5.3:1	0.25mm-210m	78	9	RD18774	
STLC3000MHGFJ	210	6.0:1	0.25mm-125m	89	9	RD19198	
STLC3000XGFJ	210	6.4:1	0.25mm-210m	94	9	RD18780	
STL4000FJ	255	5.3:1	0.25mm-260m	87	11	RD18967	
STL4000XGFJ	255	6.2:1	0.25mm-260m	101	11	RD18996	
STLC5000XGFJ	260	6.2:1	0.30mm-240m	101	11	RD19003	

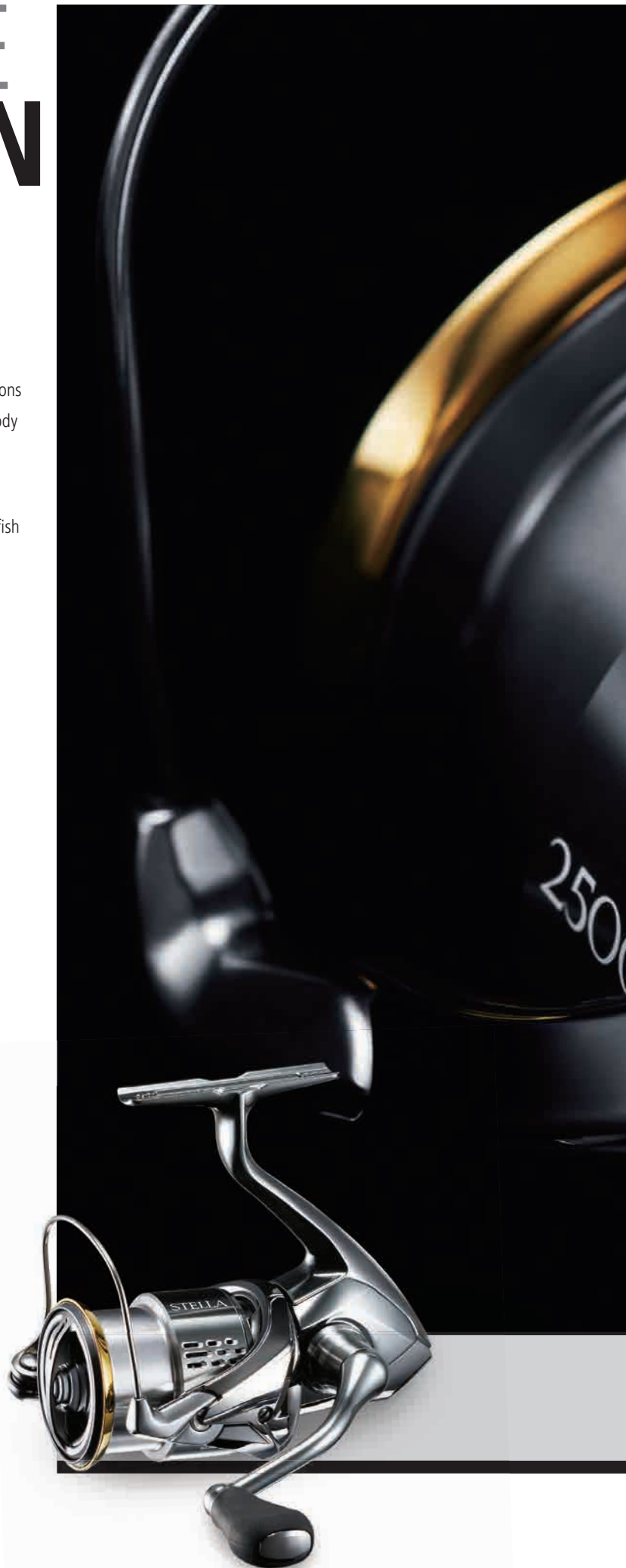



HIGHLY RIGID & DURABLE

NEW

TWIN POWER

- HAGANE Gear and Body plus X-SHIP for efficient, reliable performance
- MicroModule II gearing and SilentDrive technology for ultra smooth, whisper quiet operation
- X-Protect water protection ensuring excellent performance whilst retaining lightweight rotation
- Long Stroke AR-C Spool increases casting distance
- Aero Wrap for excellent line lay
- Suitable for saltwater fishing

SIZES: 1000, 2000, 2500, 3000, 4000, 5000

BEARINGS: 9 + 1

OSCILLATION: Aero Wrap

HANDLE: Screw in Aluminium with Septon Knob

WATERPROOF DRAG: Yes



	9	10	11	12	13	14
TP1000FD	175	5.1:1	0.18mm-170m	64	3	RD20911
TPC2000SFD	180	5.1:1	0.14mm-145m	69	3	RD20933
TP2500FD	210	5.3:1	0.20mm-160m	78	9	RD20573
TP2500SHGFD	210	6.0:1	0.16mm-150m	89	4	RD20601
TPC3000FD	215	5.3:1	0.25mm-210m	78	9	RD20606
TPC3000XGFD	215	6.4:1	0.25mm-210m	94	9	RD20612
TP4000FD	255	5.3:1	0.30mm-180m	87	11	RD20899
TP4000PGFD	260	4.4:1	0.30mm-180m	72	11	RD20906
TP4000XGFD	260	6.2:1	0.30mm-180m	101	11	RD20907
TP4000MHGFD	255	5.8:1	0.30mm-120m	95	11	RD20904
TPC5000XGFD	260	6.2:1	0.35mm-175m	101	11	RD20908



CONTINUOUS EVOLUTION

STRADIC

- HAGANE Gear, MicroModule and SilentDrive combined, deliver exquisitely smooth, quiet, lightweight rotation
- X-SHIP for increased cranking power
- X-Protect waterproof protection
- Long Stroke AR-C spool increases casting distance
- Aero Wrap for excellent line lay
- Waterproof drag
- Carbon Cross Washer

SIZES: 1000, 2500, 3000, 4000, 5000

BEARINGS: 6 + 1

OSCILLATION: Aero Wrap

HANDLE: Screw in Single Aluminium

WATERPROOF DRAG: Yes



	9	10	11	12	13	14
ST1000FL	185	5.1:1	0.18mm-170m	64	3	RD20130
ST1000HGFL	185	6.0:1	0.18mm-170m	75	3	RD20177
ST2500FL	220	5.3:1	0.20mm-240m	78	9	RD19768
ST2500HGFL	225	6.0:1	0.20mm-240m	89	9	RD20000
STC3000FL	225	5.3:1	0.25mm-210m	78	9	RD20031
STC3000HGFL	225	6.0:1	0.25mm-210m	89	9	RD20032
STC3000XGFL	225	6.4:1	0.25mm-210m	94	9	RD20039
ST4000FL	280	5.3:1	0.30mm-180m	87	11	RD20241
ST4000MHGFL	280	5.8:1	0.30mm-120m	95	11	RD20299
ST4000XGFL	280	6.2:1	0.30mm-180m	101	11	RD20309
STC5000XGFL	295	6.2:1	0.35mm-175m	101	11	RD20319



PRECISE CONTROL

Soare BB

- Designed for Trout Area, Street Fishing, light rock fishing and other applications where ultra thin line is used
- HAGANE Gear and X-SHIP for efficient performance
- Low speed gear ratio of 4.3:1 for precise control and powerful winding
- Coreprotect for protection against water intrusion to the body, drag and line roller
- Shallow spool (0.12mm - 155m) for ultra fine braided lines
- Aero Wrap for excellent line lay
- G Free body for improved balance
- AR-C cold forged aluminium spool
- Area Drag for very precise adjustment and control
- One piece bail for smooth line guidance

SIZES: 2000

BEARINGS: 5 + 1

OSCILLATION: Aero Wrap

HANDLE: Screw in Single Aluminium

WATERPROOF DRAG: Yes



51SF23B019A

200 4.3:1 0.12mm-155m 57 3 60209X8190P





Sephia BB

- Designed for squid fishing using Egi lures
- HAGANE Gear and X-SHIP for efficient performance
- Coreprotect for protection against water intrusion to the body, drag and line roller
- Special EVA handle designed for egging
- Aero Wrap for excellent line lay
- G Free body for improved balance
- AR-C cold forged aluminium spool
- Rapid Fire drag (9kg max) for quick adjustment and control
- One piece bail for the smooth line guidance

SIZES: 3000

BEARINGS: 5 + 1

OSCILLATION: Aero Wrap

HANDLE: Screw in Single Aluminium



51SF26E030A | 235 5.0:1 0.25mm-210m 73 9 60209Y1300P



ULTEGRA

- HAGANE Gear to withstand the toughest conditions
- X-SHIP for increased cranking power and smooth rotation under heavy load
- G Free body for improved balance and reduced fatigue
- Aero Wrap for excellent line lay for mono and ultra fine braid
- Coreprotect to prevent water intrusion
- AR-C cold forged aluminium spool
- Waterproof drag

SIZES: 1000, 2500, 3000, 4000, 5000

BEARINGS: 5 + 1

OSCILLATION: Aero Wrap

HANDLE: Folding Single Aluminium



	9	9	W	9	9	9
ULT1000FB	200	5.0:1	0.18mm-170m	66	3	RD18110
ULT2500FB	240	5.0:1	0.18mm-290m	73	9	RD18037
ULT2500HGFB	240	6.0:1	0.18mm-290m	88	9	RD18037
ULTC3000FB	240	5.0:1	0.25mm-210m	73	9	RD18050
ULTC3000HGFB	240	6.0:1	0.25mm-210m	88	9	RD18050
ULT4000FB	285	4.8:1	0.25mm-260m	77	11	RD18089
ULT4000XGFB	285	6.2:1	0.25mm-260m	99	11	RD18089
ULTC5000XGFB	285	6.2:1	0.30mm-240m	105	11	RD18100

TRUE LIGHTNESS

Vanquish

- The lightest reel (like for like size) ever made by SHIMANO, perfect for lightweight and powerful fishing in fresh and saltwater
- MicroModule II gear for ultra smooth winding
- HAGANE Gear and X-SHIP for efficient performance
- SilentDrive, re-engineered components reduce microscopic movement in the handle resulting in quieter operation
- X-Protect technology gives high level water protection, ensuring excellent performance whilst retaining lightweight rotation
- MGL rotor enhances lightweight rotation
- Long Stroke Spool increases casting distance
- Aero Wrap for excellent line lay

SIZES: 2000, 2500, 3000, 4000, 5000

BEARINGS: 11 + 1

OSCILLATION: Aero Wrap

HANDLE: Screw in Ci4+ (2000-4000 models)
Screw in Single Aluminium (5000 model)

WATERPROOF DRAG: Yes

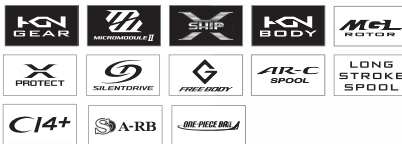

	9	10	11	12	13	14
VQC2000SFB	145	5.1:1	0.18mm-80m	69	3	RD19264
VQC2500SHGFB	155	6.0:1	0.16mm-150m	81	3	RD19287
VQ2500SFB	165	5.3:1	0.16mm-150m	78	4	RD19081
VQ2500SHGFB	165	6.0:1	0.16mm-150m	89	4	RD19145
VQC3000FB	170	5.3:1	0.25mm-210m	78	9	RD19152
VQC3000MHGFB	170	6.0:1	0.25mm-125m	89	9	RD19155
VQ4000MHGFB	205	5.8:1	0.30mm-120m	95	11	RD19391
VQ4000XGFB	200	6.2:1	0.30mm-180m	101	11	RD19348
VQC5000XGFB	220	6.2:1	0.35mm-175m	101	11	RD19401



IMMENSELY STRONG

EXSENCE

- Lightweight but immensely strong reel featuring the newest high-end materials and technologies
- Size 3000 only weigh 220g, but is equipped with a very strong 9kg waterproof drag
- Combination of the MicroModule gear and G Free body results in a very strong and smoothly running reel, which stays in balance while reeling in at high speed
- Designed for inshore fishing for sea bass and bluefish, but also popular for freshwater lure fishing when fishing with fine braided lines

SIZES: 3000, 4000

BEARINGS: 11 + 1

OSCILLATION: Aero Wrap

HANDLE: Screw in Single Aluminium

WATERPROOF DRAG: Yes



	Weight	Ratio	Line Capacity	Length	Spool Turns	Model
EXSC3000MHG	220	6.0:1	0.25mm-125m	88	9	RD18650
EXS4000MXG	245	6.2:1	0.30mm-110m	99	11	RD18472

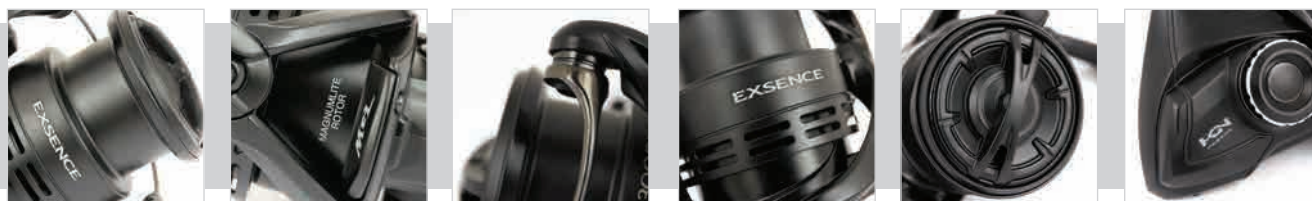

INCREASED STRENGTH

TWIN POWER XD

- Increased strength HAGANE Gear to overcome the most extreme pressure
- HAGANE Body for assured protection and rigidity with advanced G Free design
- X-Protect to prevent water intrusion to the line roller and roller clutch
- Durable cross carbon drag for improved fighting control
- X-SHIP for increased cranking power and smooth rotation under heavy load
- Aero Wrap for excellent line lay
- Lightweight Magnumlite Rotor, made of C14+ material, for smooth winding control
- AR-C lightweight cold forged aluminium spool with TI coating

SIZES: 3000, 4000, 5000

BEARINGS: 9 + 1

OSCILLATION: Aero Wrap

HANDLE: Screw in Single Aluminium

WATERPROOF DRAG: Yes



	9	10	11	12	13	14
TPXDC3000HG	235	6.0:1	0.25mm-210m	88	9	RD18179
TPXDC3000XG	235	6.4:1	0.25mm-210m	93	9	RD18159
TPXD4000XG	290	6.2:1	0.25mm-260m	99	11	RD18182
TPXDC5000XG	300	6.2:1	0.35mm-175m	103	11	RD18197





SUSTAIN

- All-round front drag spinning reel with exciting new features
- X-Protect features water repellent plus a special labyrinth structure to keep water out of the reel body
- Stronger gearing by comparison to former model
- Cross carbon drag washers suitable for heavy conditions
- G Free Body for better balance and less fishing fatigue

SIZES: 2500, 3000, 4000, 5000

BEARINGS: 8+1

OSCILLATION: Aero Wrap

HANDLE: Screw in Single Aluminium

WATERPROOF DRAG: Yes



SA2500FI	235	5.0:1	0.18mm-290m	73	9		RD18205
SAC3000HGFI	225	6.0:1	0.25mm-210m	88	9		RD18229
SA4000FI	280	4.8:1	0.25mm-260m	77	11		RD18362
SA4000XGFI	285	6.2:1	0.25mm-260m	99	11		RD18376
SAC5000XGFI	285	6.2:1	0.30mm-240m	103	11		RD18379



CARDIFF CI4+

- Designed for Trout Area fishing (1000 size) and native trout applications (3000 size)
- HAGANE Gear and X-SHIP for efficient performance
- Ultra lightweight Ci4+ construction
- MGL rotor enhances lightweight rotation
- Coreprotect for protection against water intrusion to the body, drag and line roller (1000 size) X-Protect (3000 size)

SIZES: 1000, 3000

BEARINGS: 9+1

OSCILLATION: Aero Wrap

HANDLE: Screw in Single Aluminium

WATERPROOF DRAG: Yes



51SF22B010A	170	5.0:1	0.14mm-115m	66	3		-
51SF22E032A	200	6.0:1	0.25mm-125m	88	9		-

SUPER FAST

NEW

VANFORD

- Vanford is the new 'entry-level' Magnumlite Series reel designed for sensitive and finesse techniques
- Features Ci4+ Body and Rotor for remarkable lightweight performance
- MGL Rotor and Micromodule II gear for ultra sensitive, lightweight rotation suitable for precise lure control
- MicroModule II Gear and SilentDrive for ultra smooth, ultra quiet operation, even under pressure
- HAGANE Gear and X-SHIP for efficient, powerful performance
- X-Protect for high level water protection of line roller (all models) and body (except 500) ensuring excellent performance whilst retaining lightweight rotation
- Long Stroke Spool increases casting distance
- Aero Wrap for excellent line lay, even when using ultra fine braid
- Suitable for both fresh and saltwater applications

SIZES: 500, 1000, 2000, 2500, 3000, 4000, 5000

BEARINGS: 6 + 1 (500 model) 7 + 1

OSCILLATION: Aero Wrap

HANDLE: Screw in Single Aluminium

WATERPROOF DRAG: Yes



	9	9	9	9	9	9
VF500F	140	5.6:1	0.20mm-110m	69	2.5	-
VF1000F	150	5.1:1	0.20mm-140m	64	3	-
VFC2000SF	150	5.1:1	0.14mm-145m	69	3	-
VFC2000SHGF	150	6.1:1	0.14mm-145m	82	3	-
VF2500F	180	5.3:1	0.25mm-160m	78	9	-
51SF36E026A	175	5.3:1	0.18mm-120m	78	4	-
VF2500SHGF	175	6.0:1	0.16mm-150m	89	4	-
VF2500HGF	180	6.0:1	0.25mm-160m	89	9	-
VFC3000F	180	5.3:1	0.25mm-210m	78	9	-
VFC3000HGF	180	6.0:1	0.25mm-210m	89	9	-
VF4000F	215	5.3:1	0.30mm-180m	87	11	-
VF4000MHGF	215	5.8:1	0.25mm-165m	95	11	-
VF4000XGF	215	6.2:1	0.30mm-180m	101	11	-
VFC5000XGF	220	6.2:1	0.35mm-175m	101	11	-







NASCI

- HAGANE Gear to withstand the toughest conditions
- X-SHIP gearing for maximum winding efficiency
- G Free Body for optimum balance
- Varispeed II line lay and AR-C spool for improved casting
- Coreprotect for protection against water intrusion

SIZES: 500, 1000, 2000, 2500, 3000, 4000, 5000

BEARINGS: 4 + 1

OSCILLATION: Varispeed II

HANDLE: Single Aluminium



NAS500FB	175	5.6:1	0.20mm-110m	69	2.5	RD18688
NAS1000FB	215	5.0:1	0.18mm-170m	66	3	RD17959
NASC2000SFB	220	5.0:1	0.18mm-80m	66	3	RD17974
NASC2000HGFSFB	220	6.0:1	0.18mm-80m	79	3	RD17974
NAS2500FB	250	5.0:1	0.20mm-240m	73	9	RD17848
NAS2500HGFSFB	250	6.2:1	0.20mm-95m	91	4	RD17867
NASC3000FB	250	5.0:1	0.25mm-210m	73	9	RD17871
NASC3000HGFB	250	6.2:1	0.25mm-210m	91	9	RD17871
NAS4000FB	295	4.7:1	0.30mm-180m	75	11	RD17933
NAS4000XGFB	295	6.2:1	0.30mm-180m	99	11	RD17933
NASC5000XGFB	300	6.2:1	0.35mm-175m	105	11	RD17953

SAHARA

- HAGANE Gear to withstand the toughest conditions
- X-SHIP for increased cranking power and smooth rotation under heavy load
- Free G Body for optimum balance and reduced fatigue
- Varispeed II line lay and AR-C spool for improved casting

SIZES: 500, 1000, 2000, 2500, 3000, 4000, 5000

BEARINGS: 4 + 1

OSCILLATION: Varispeed II

HANDLE: Single Aluminium, Double Aluminium



SH500FI	175	6.2:1	0.20mm-110m	69	2.5	RD18914
SH1000FI	215	5.0:1	0.18mm-170m	66	3	RD18061
SHC2000SFI	220	5.0:1	0.14mm-145m	66	3	RD18071
SHC2000HGFSFI	220	6.0:1	0.14mm-145m	79	3	RD18071
SH2500FI	250	5.0:1	0.18mm-290m	73	9	RD18017
SH2500HGFSFI	250	6.2:1	0.16mm-150m	91	4	RD18028
SHC3000FI	250	5.0:1	0.25mm-210m	73	9	RD18030
SHC3000HGFI	250	6.2:1	0.25mm-210m	91	9	RD18030
SHC3000DHFI	280	5.0:1	0.25mm-210m	73	9	RD18030
SH4000FI	295	4.7:1	0.25mm-260m	75	11	RD18074
SH4000XGFI	295	6.2:1	0.25mm-260m	99	11	RD18074
SHC5000XGFI	300	6.2:1	0.30mm-240m	105	11	RD18084

SEDONA

- SHIMANO's most affordable HAGANE Gear reel
- Varispeed II line lay for improved casting
- Cold forged AR-C spool

BEARINGS: 3 + 1 | **OSCILLATION:** Varispeed II



Model	Weight (g)	Ratio	Line Capacity (mm-m)	Line Diameter (mm)	Spool Type	RD
SE500FI	185	5.6:1	0.20mm-110m	69	2.5	RD19054
SE1000FI	215	5.0:1	0.18mm-170m	66	3	RD18122
SEC2000SFI	215	5.0:1	0.14mm-145m	66	3	RD18128
SEC2000HGSFI	215	6.0:1	0.14mm-145m	79	3	RD18128
SE2500FI	245	5.0:1	0.18mm-290m	73	4	RD18132
SE2500HGFI	245	6.2:1	0.18mm-290m	91	4	RD18132
SE2500SFI	245	5.0:1	0.16mm-150m	73	4	RD18138
SEC3000FI	250	5.0:1	0.25mm-210m	73	9	RD18141
SEC3000HGFI	250	6.2:1	0.25mm-210m	91	9	RD18141
SEC3000DHFI	275	5.0:1	0.25mm-210m	73	9	RD18141
SE4000FI	295	4.7:1	0.25mm-260m	75	11	RD18147
SE4000XGFI	295	6.2:1	0.25mm-260m	99	11	RD18147
SEC5000XGFI	300	6.2:1	0.30mm-240m	105	11	RD18154
SE6000FI	425	4.6:1	0.33mm-240m	83	10	RD18331
SE8000FI	615	4.9:1	0.37mm-275m	94	11	RD18346



NEXAVE

- Ideal for all kinds of freshwater fishing
- Perfectly adjustable drag will help fighting big fish without any problem

BEARINGS: 3+ 1 | **OSCILLATION:** Varispeed II



Model	Weight (g)	Ratio	Line Capacity (mm-m)	Line Diameter (mm)	Spool Type	RD
NEX1000FE	215	5.0:1	0.18mm-170m	61	3	RD18533
NEX2500FE	255	5.0:1	0.18mm-290m	71	4	RD18545
NEX2500HGFE	255	6.2:1	0.18mm-290m	88	4	RD18556
NEXC3000FE	260	5.0:1	0.25mm-210m	71	8.5	RD18557
NEXC3000HGFE	260	6.2:1	0.25mm-210m	88	8.5	RD18560
NEX4000FE	325	5.2:1	0.25mm-260m	82	8.5	RD18561
NEX4000HGFE	325	5.8:1	0.25mm-260m	91	8.5	RD18567
NEXC5000HGFE	320	5.8:1	0.30mm-240m	93	8.5	RD18568
NEX6000FE	595	4.9:1	0.35mm-240m	91	8	RD19037
NEX8000FE	580	4.9:1	0.40mm-200m	92	8	RD19050



CATANA

- Modern stealth looks to suit the latest fashion
- Fantastic value for money, combined with excellent SHIMANO engineering, which can be used for a wide range of freshwater techniques

BEARINGS: 2 + 1 | **OSCILLATION:** Varispeed II



Model	Weight (g)	Ratio	Line Capacity (mm-m)	Line Diameter (mm)	Spool Type	RD
CAT1000FD	215	5.0:1	0.18mm-170m	61	3	RD18852
CAT2500FD	260	5.0:1	0.18mm-290m	71	4	RD18858
CAT2500HGFD	260	6.2:1	0.18mm-290m	88	4	RD18863
CATC3000FD	260	5.0:1	0.25mm-210m	71	8.5	RD18866
CATC3000HGFD	260	6.2:1	0.25mm-210m	89	8.5	RD18868
CAT4000FD	335	5.2:1	0.25mm-260m	82	8.5	RD18869
CAT4000HGFD	335	5.8:1	0.25mm-260m	91	8.5	RD18874





ALIVIO

- A stunning front drag reel offering excellent value for specimen and carp anglers
- Varispeed line lay, resulting in longer and more accurate casts
- 4.9:1 gear ratio provides good winding power for big fish
- Available in powerful 6000 and 10000 sizes for specimen fishing or light surf casting

BEARINGS: 1 + 1 | **OSCILLATION:** Varispeed II

ALV6000FA	590	4.9:1	0.35mm-240m	90	8	RD10715
ALV10000FA	580	4.9:1	0.35mm-380m	94	8	RD10725



SIENNA

- The ideal choice for an angler who is just starting fishing or for someone on a tight budget
- A reliable reel with a strong XT-7 body
- Smooth SHIMANO gearing
- Aluminium AR-C spool

BEARINGS: 3 + 1 | **OSCILLATION:** Varispeed II

SN500FG	195	5.6:1	0.20mm-110m	69	2	-
SN1000FG	225	5.0:1	0.18mm-170m	66	3	-
SN2000FG	250	5.0:1	0.18mm-215m	71	4	-
SN2500FG	250	5.0:1	0.25mm-160m	71	4	-
SN2500HGFG	250	6.2:1	0.25mm-160m	88	4	-
SNC3000FG	250	5.0:1	0.25mm-210m	71	8.5	-
SN4000FG	320	5.2:1	0.30mm-180m	82	8.5	-



FX

- An all round spinning reel which replaces the previous FX, AX and HYPERLOOP reels
- The ideal choice for an angler who is just starting fishing or for someone on a tight budget
- A reliable reel with a strong XT-7 body, smooth SHIMANO gearing and aluminium AR-C spool

BEARINGS: 2 + 1 | **OSCILLATION:** Varispeed II

FX1000FC	225	5.0:1	0.18mm-170m	66	3	-
FX2000FC	250	5.0:1	0.18mm-215m	71	4	-
FX2500FC	250	5.0:1	0.25mm-160m	71	4	-
FX2500HGFC	250	6.2:1	0.25mm-160m	88	4	-
FXC3000FC	250	5.0:1	0.25mm-210m	71	8.5	-
FX4000FC	320	5.2:1	0.30mm-180m	82	8.5	-





REAR DRAG REELS

For all-round fishing (float, feeder, spinning) SHIMANO rear drag reels offer great versatility. The position of the rear drag adjustment at the rear of the reel makes it very easy to use and many models also feature SHIMANO Fightin' Drag for even easier adjustment whilst fighting a fish.

28	STRADIC C14+ RA STRADIC GTM-RC
29	SUPER GT RD SAHARA R / R DH
30	CATANA RC SIENNA RE

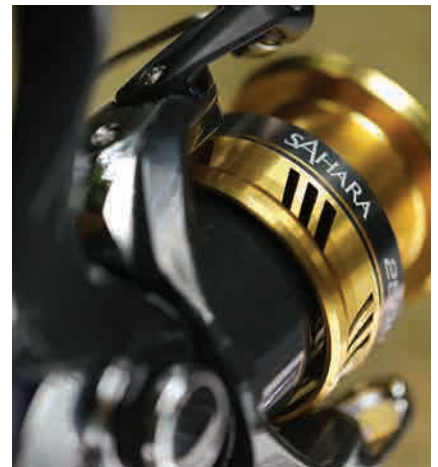



STRADIC Ci4+

- Ultra lightweight Ci4+ body material delivers outstanding weight reduction
- SHIMANO's famous quick adjustment Fightin' Drag allows easy drag adjustments whilst playing fish
- 2500 size has high gear 6.0:1 retrieve
- Aero Wrap for improved line lay
- Push button, quick release spool
- Cold forged aluminium spare spool

SIZES: 2500, 4000

BEARINGS: 5 + 1

OSCILLATION: Aero Wrap

HANDLE: Screw in Single Aluminium

SPARE SPOOL: 1 x Cold Forged Aluminium



SPOOL REDUCER

2500 - Shallow line reducer x 2

4000 - Shallow line reducer x 2



0.25mm-90m



0.20mm-110m

RD16808

RD17135

Model	Weight (g)	Retrieve Ratio	Line Capacity	Retrieves (m)	Drag (kg)	Parts	Accessories
STCi42500RA	255	6.0:1	0.20mm-240m	98	2.5	RD17094	
STCi44000RA	310	5.2:1	0.25mm-260m	93	3	RD17114	



STRADIC GTM

- A classic SHIMANO reel that has established an enviable reputation for its looks, quality and performance
- GTM reels have a super-fast retrieve ratio of 6.0:1 or 5.8:1
- SHIMANO's famous quick adjustment Fightin' Drag allows increase or decrease of the drag instantly
- Pearl-white XT-7 body, rotor and double handle complimented by an AR-C Cold Forged aluminium spool
- Push button, quick release spool
- 3000S and 4000S sized reels have shallow spools and shallow spare spools

SIZES: 2500, 3000, 4000

BEARINGS: 4 + 1

OSCILLATION: Aero Wrap

HANDLE: Double

SPARE SPOOL: 1 x Cold Forged Aluminium



Model	Weight (g)	Retrieve Ratio	Line Capacity	Retrieves (m)	Drag (kg)	Parts	Accessories
STR2500GTMRC	315	6.0:1	0.20mm-240m	88	2.5	RD13148	
STR3000SGTMRC	345	6.0:1	0.25mm-140m	92	2.5	RD13165	
STR4000SGTMRC	390	5.8:1	0.30mm-100m	95	3	RD13134	



SUPER GT

- SHIMANO's famous quick adjustment Fightin' Drag allows quick adjustments of the drag system
- Single machined aluminium handle for increased winding power
- Push button quick release AR-C spool for improved casting
- Aero Wrap oscillation for excellent line lay
- Power Roller reduces line twist

SIZES: 2500, 4000

BEARINGS: 3 + 1

OSCILLATION: Aero Wrap

HANDLE: Single Aluminium

SPARE SPOOL: 1 x XT-7



SPOOL REDUCER

- 2500 - Shallow line reducer x 2
- 4000 - Shallow line reducer x 2

0.25mm-90m RD16808	
0.20mm-110m RD17135	

SUP2500GTRD	290	5.0:1	0.20mm-240m	82	2.5	RD17300
SUP4000GTRD	355	4.8:1	0.25mm-260m	86	3	RD17312

SAHARA

- A mid-level rear drag model with eye-catching stunning metallic platinum and gold finish
- Excellent multi-disk rear drag system and Fightin' Drag
- Varispeed line lay prevents fine mono and braid bedding in under pressure
- For match anglers there is also a high speed (6.2:1) 3000 size
- Ideal for many freshwater angling purposes, whether it is lure fishing for pike or match fishing for bream
- For match/commercial/feeder fishing the Sahara RD matches well with the new Aernos Commercial rods

SIZES: 2500, 3000, 4000

BEARINGS: 3 + 1

OSCILLATION: Varispeed

HANDLE: Double Aluminium

SPARE SPOOL: 1 x Cold Forged Aluminium



SINGLE HANDLE

SH1000R	255	5.2:1	0.20mm-140m	69	2	RD18273
SH2500R	275	5.2:1	0.25mm-160m	76	2	RD18291
SH3000SR	280	5.2:1	0.25mm-140m	76	2	RD18299
SH4000R	335	5.1:1	0.30mm-180m	82	3	RD18307

DOUBLE HANDLE

SH2500DHR	320	5.2:1	0.25mm-160m	76	2	RD18291
SH3000SSDHHGR	355	6.2:1	0.18mm-130m	91	2	RD18302
SH4000DHR	375	5.1:1	0.30mm-180m	82	3	RD18307



CATANA

- The CATANA RC perfectly fits the needs of anglers looking for a low-budget, but smoothly running rear drag reel
- Designed for freshwater fishing, mainly aiming at Bolognese, tele trout and young anglers spin fishing for perch, pike or zander
- The smoothly running drag has enough power to fish on commercials and fight carp and other hard-fighting fish
- The combination of the excellent price, SHIMANO quality and modern design makes this reel a perfect model for both new and experienced anglers

SIZES: 1000, 2500, 3000, 4000

BEARINGS: 2 + 1

OSCILLATION: Varispeed II

HANDLE: Single

SPARE SPOOL: 1 x XT-7



CAT1000RC	270	5.2:1	0.18mm	170m	69	2	RD18627
CAT2500RC	300	5.2:1	0.20mm	240m	76	2	RD18635
CAT3000SRC	300	5.2:1	0.18mm	240m	76	2	RD18639
CAT4000RC	370	5.1:1	0.30mm	180m	82	3	RD18641



SIENNA

- Exceptional value for money offering smooth, assured performance across a wide range of fishing styles
- Easily adjustable rear drag for confident fish-playing performance
- Aluminium AR-C spool for improved casting performance
- New design rotor offering good balance when retrieving at high speed
- Higher grade composite material for lightness and strength
- Push button, quick release spool

SIZES: 1000, 2500, 4000

BEARINGS: 1 + 1

OSCILLATION: Varispeed II

HANDLE: Single



SN1000RE	270	5.2:1	0.18mm	170m	69	2	RD19009
SN2500RE	300	5.2:1	0.20mm	240m	76	2	RD19016
SN4000RE	365	5.1:1	0.25mm	260m	82	3	RD19019



BIG PIT REELS

On larger waters, where casting distance is essential, using the correct reel is as important as using the correct rod. SHIMANO Big Pit/Surfcasting reels, with Slow Oscillation, Super Slow Oscillation and the new Parallel Body design add noticeable casting distance compared to other reels of the same size.

Slow line oscillation wraps the line onto the spool in a more organised way, with the coils of line laying closer to the next one on the spool. On Parallel Body design reels the body of the reel is parallel to the blank of the rod, rather than the reel tilting slightly towards the rod.

The combination of Slow or Super Slow Oscillation and Parallel Body offers the ultimate in distance casting performance.

- 34 AERO TECHNIUM MGS XTC / XSC
- 36 FLIEGEN SD
- 37 POWER AERO XTb / XSB
- 38 SURF LEADER CI4+
- 39 ULTEGRA CI4+ XTC / XSC
- 40 ULTEGRA XTD / SPOD
- 41 ULTEGRA XSD / COMPETITION
- 42 SPEEDMASTER XTC / XSC
- 43 AERLEX XTb / XSB · BEASTMASTER XB



LONG RANGE CASTING TECHNOLOGY

OFFERING THE ULTIMATE IN DISTANCE CASTING PERFORMANCE

On larger waters, where casting distance is essential, using the correct reel is almost as important as using the correct rod. SHIMANO Big Pit reels, with Slow and Super Slow Oscillation and the Parallel Body design add noticeable casting distance compared to other reels of the same size.



PARALLEL BODY

Parallel Body is a new feature that is designed to improve dynamic line flow from the reel to the first guide. On many reels the spool is aligned slightly upwards towards the rod blank, but with Parallel Body it is at exactly 90° to the blank. The result is less line slap the blank as it travels towards the first guide during casting.





HI-SPEED DRAG

Hi-speed drag is SHIMANO's fastest drag system and can change the drag setting from free-spool mode to fighting mode with only a very small turn to the knob located on the front of the spool.

SPOOL REDUCERS

SHIMANO Spool Reducers instantly reduce the line capacity of the spool. Supplied with Big Pit reels, there are three sizes.

- 3500 - 0.20mm = 200m
- 6000 - 0.30mm = 200m
- 10000 - 0.40mm = 300m



OSCILLATION

Slower spool oscillation reduces the speed the line travels up and down the spool on the cast. This results less friction as line leaves the spool and reduced drag on the lead, which improves casting distance and accuracy.

SHIMANO STANDARD Oscillation (up to 20 wraps per cycle) outperforms the industry standard. SHIMANO SLOW Oscillation (up to 40 wraps per cycle) exceeds almost anything else ever seen. Super Slow Oscillation systems - SUPER SLOW 5 (55 wraps per cycle) and SUPER SLOW 10 (105 wraps per cycle) the ultimate line lay.

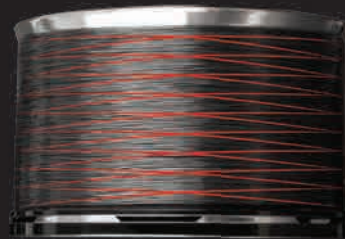
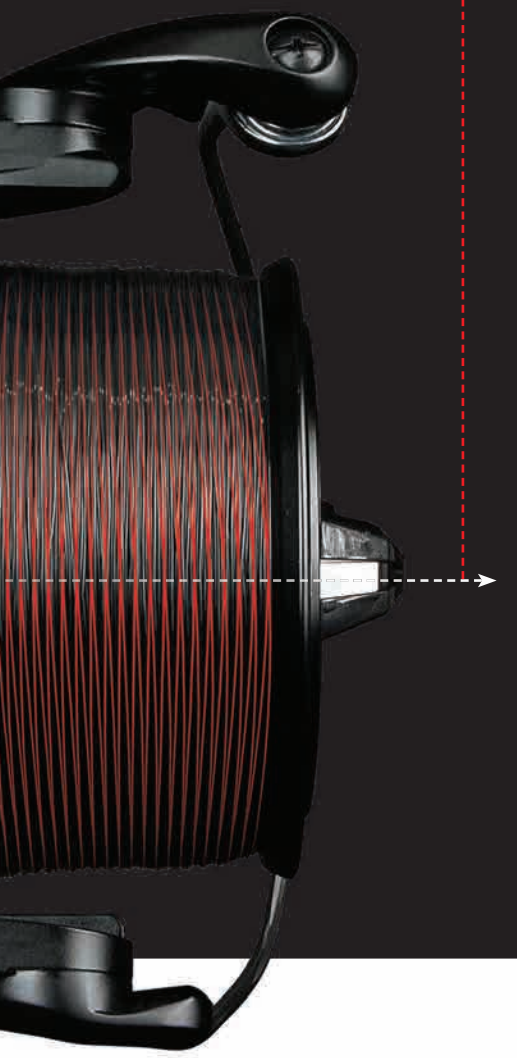

STANDARD

STANDARD Oscillation Up to 20 wraps



SLOW

SLOW Oscillation 35 - 40 wraps

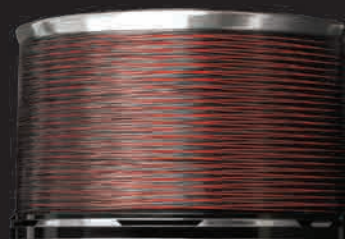

SUPER SLOW 5

SUPER SLOW 5 Oscillation 45-55 wraps

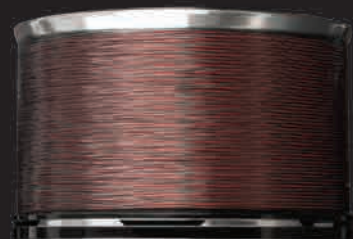

SUPER SLOW 10

SUPER SLOW 10 Oscillation 95-105 wraps

PERFORMS FROM WITHIN

AERO TECHNIUM MgS XTC/XSC

- New version of Europe's most iconic carp reel features over 50% new and improved parts
- Magnesium body and Ci4+ rotor dramatically reduces the overall weight of the reel to just 485g
- HAGANE X-SHIP gearing for maximum winding power and efficiency even under extreme pressure
- AR-C spool reduces line problems when distance casting
- Super Slow Oscillation (100 turns per full oscillation) and Aero Wrap for the ultimate in SHIMANO line lay and casting potential
- High speed waterproof drag for instant adjustment when fishing
- X-Protect line roller and waterproof roller clutch for protection

SIZES: 14000

BEARINGS: 8 + 1

OSCILLATION: Super Slow 10 + Aero Wrap

HANDLE: Screw in Single Aluminium

SPARE SPOOL: 1 x Cold Forged Aluminium



SPOOL REDUCER

3500 - Shallow line reducers x2	0.20mm-200m
6000 - Shallow line reducers x2	0.30mm-200m
10000 - Shallow line reducers x2	0.40mm-300m

ARTCMGS14000XTC	485	4.3.1	0.35mm-550m	103	20	RD18947
ARTCMGS14000XSC	485	4.3.1	0.35mm-550m	103	20	RD18922





REEL TECHNOLOGY

FRONT DRAG REELS

REAR DRAG REELS

BIG PIT REELS

BAITRUNNER REELS

BAITCASTING REELS

SALTWATER REELS

MULTIPLIERS

EXTREMELY LIGHT

FLIEGEN SD

- Exceptionally lightweight, eye-catching surf reel
- X-Protect prevents water getting into the inner workings of the reel by means of a labyrinth structure which does not impair rotation lightness
- Equipped with X-SHIP and newly designed Ci4+ rotor as well as a Hi-Speed drag
- G Free Body and Parallel Body to reduce the amount of line touching the blank when casting

SIZES: 10000
BEARINGS: 8 + 1
OSCILLATION: Aero Wrap
HANDLE: Screw in Single Aluminium



55A60C000

490 3.5:1 0.20mm-250m 84 20 03658-0138



STEALTH LOOKS

POWER AERO XTB/XSB

- An eye-catching 'Big Pit' reel in fashionable stealth colours
- Equipped with innovative technological features like strong HAGANE Gear and HAGANE Body, X-SHIP to provide maximum power and smoothness
- X-Protect prevents water ingress into the inner workings of the reel without reducing winding resistance
- Compact body compared to spool size creates a sleek profile and reduces weight
- The Parallel Body, in combination with the superb line-lay of the Super Slow 5 System, increases casting performance
- Hi-Speed drag, which is even faster than Instant Drag, enables you to switch instantly from a free running spool to fighting mode with only a very small turn of the drag knob

SIZES: 14000

BEARINGS: 8 + 1

OSCILLATION: Super Slow 5 + Aero Wrap

HANDLE: Screw in Single Aluminium

SPARE SPOOL: 1 x Cold Forged Aluminium



SPOOL REDUCER

3500 - Shallow line reducers x2	0.20mm-200m
6000 - Shallow line reducers x2	0.30mm-200m
10000 - Shallow line reducers x2	0.40mm-300m

PA14000XTB	510	4.3:1	0.35mm-550m	103	20	RD18606
PA14000XSB	510	4.3:1	0.35mm-550m	103	20	RD18571



POWERFUL WINDING

SURF LEADER C14+ SD

- Designed for ultra long surf casting with thin braided lines
- X-Protect technology gives high level water protection, ensuring excellent performance whilst retaining lightweight rotation
- Parallel Body design with Slow Oscillation for increased distance casting performance
- Hi-Speed Drag can be adjusted from zero to maximum drag in just one turn of the control knob
- Shallow spool (0.20mm - 250m) for fine diameter lines
- G Free body for improved balance
- AR-C cold forged aluminium spool

SIZE: 14000

BEARINGS: 4 + 1

OSCILLATION: Aero Wrap

HANDLE: Screw in Single Aluminium



51SA62E000A

535 3.5:1 0.20mm-250m 84 20 03893-0211



COMPACT BODY

ULTEGRA CI4+ XTC | XSC

- An eye-catching reel design
- Ci4+ delivers a substantial weight saving on the compact body making rod speed easier to generate when distance casting
- Super Slow 5 Oscillation (14000), Slow (5500) line lay and an AR-C spool fitted with the new Hi-Speed drag mechanism increase casting performance
- SHIMANO's latest innovation X-Protect will guarantee to protect the reel's inner parts against intrusion from water and dirt
- G Free Body in combination with Parallel Body will help to achieve long and accurate casts without unnecessary fatigue
- The very compact body design contributes to the excellent balance of this compact, lightweight big pit reel

SIZES: 5500, 14000

BEARINGS: 5 + 1

OSCILLATION: Super Slow 5 (14000) + Aero Wrap
Slow (5500) + Aero Wrap

HANDLE: Single Aluminium

SPARE SPOOL: 1 x Cold Forged Aluminium

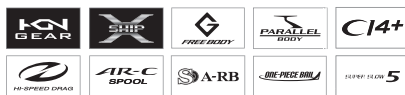

SPOOL REDUCER

3500 - Shallow line reducers x2	0.20mm-200m
6000 - Shallow line reducers x2	0.30mm-200m
10000 - Shallow line reducers x2	0.40mm-300m

	g	⚙️	📏	👤	📦	📦
ULTCI45500XTC	440	5.3:1	0.30mm-390m	105	15	RD18814
ULTCI414000XTC	540	4.3:1	0.35mm-550m	103	20	RD18515
ULTCI45500XSC	440	5.3:1	0.30mm-390m	105	15	RD18799
ULTCI414000XSC	540	4.3:1	0.35mm-550m	103	20	RD18489



X-SHIP GEARING

ULTEGRA XTD

- X-SHIP gearing for maximum winding power and efficiency even under pressure
- Super Slow 5 Oscillation (14000), Slow Oscillation (5500) with Aero Wrap for amazing casting performance
- AR-C spool also increases distance casting
- Parallel Body design ensures reel is perfectly positioned for distance casting
- Super fast Instant Drag spool system (only one turn required from on to off)
- Supplied with 1 spare Cold Forged Aluminium spool and 4 line reducers

SIZE: Spod, 5500, 14000

BEARINGS: 4 + 1

OSCILLATION: Super Slow 5 (14000) + Aero Wrap
Slow (5500) + Aero Wrap

HANDLE: Single Aluminium

SPARE SPOOL: 1 x Cold Forged Aluminium



SPOOL REDUCER

(5500) 3500 - Shallow line reducers x2	0.20mm-200m
(5500) 4500 - Shallow line reducers x2	0.35mm-220m
(14000) 3500 - Shallow line reducers x2	0.20mm-200m
(14000) 10000 - Shallow line reducers x2	0.40mm-300m

ULT5500XTD	500	5.3:1	0.30mm-390m	105	15	RD17987
ULT14000XTD	620	4.3:1	0.40mm-400m	103	20	RD17613
ULTSPDXTD	630	5.2:1	0.30mm-390m	124	20	RD18828



AMAZING CASTING

ULTEGRA XSD

- X-SHIP gearing for maximum winding power and efficiency even under pressure
- Super Slow 5 Oscillation (14000), Slow Oscillation (5500) with Aero Wrap for amazing casting performance
- AR-C spool also increases distance casting
- Parallel Body design ensures reel is perfectly positioned for distance casting
- Super fast Instant Drag spool system (only one turn required from on to off)
- Supplied with 1 spare Cold Forged Aluminium spool and 4 line reducers

SIZE: 3500 Comp, 5500, 14000

BEARINGS: 4 + 1

OSCILLATION: Super Slow 5 (14000) + Aero Wrap
Slow (5500) + Aero Wrap

HANDLE: Single Aluminium

SPARE SPOOL: 1 x Cold Forged Aluminium



SPOOL REDUCER

(5500) 3500 - Shallow line reducers x2	0.20mm-200m
(5500) 4500 - Shallow line reducers x2	0.35mm-220m
(14000) 3500 - Shallow line reducers x2	0.20mm-200m
(14000) 10000 - Shallow line reducers x2	0.40mm-300m

	9	10	11	12	13	14	15
UL35XSDCOMP	645	4.3.1	0.20mm-200m	103	20	RD17927	
ULT5500XSD	500	5.3.1	0.30mm-390m	105	15	RD18006	
ULT14000XSD	620	4.3.1	0.40mm-400m	103	20	RD17646	



MASTER YOUR SPEED

SpeedMaster XTC | XSC

- X-SHIP gearing for efficient winding power
- Parallel Body design with Super Slow 5 Oscillation for increased distance casting performance
- G Free body for improved balance
- AR-C cold forged aluminium spool
- Instant Drag can be adjusted from zero to maximum drag in just one turn of the control knob
- Aero Wrap for excellent line lay and improved casting performance
- 4.3:1 gear ratio retrieves 103cm of line per handle turn

SIZES: 14000

BEARINGS: 4 + 1

OSCILLATION: Super Slow 5 + Aero Wrap

HANDLE: Single Aluminium



SPOOL REDUCER

3500 - Shallow line reducers x1

0.20mm-200m

10000 - Shallow line reducers x1

0.40mm-300m

SPM14000XTC	625	4.3:1	0.35mm-550m	103	20	RD19325
SPM14000XSC	625	4.3:1	0.35mm-550m	103	20	RD19293





REEL TECHNOLOGY

FRONT DRAG REELS

REAR DRAG REELS

BIG PIT REELS

BAITRUNNER REELS

BAITCASTING REELS

SALTWATER REELS

MULTIPLIERS



AERLEX XTB

- Outstanding value for money and quality
- Aero Wrap, and an AR-C spool combine to add casting distance
- 4.6:1 gear ratio (10000 size) provides strong winding power
- Special high speed 5.3:1 (Spod version) retrieves 115cm of line per handle turn
- Instant Drag allows simple depth finding with a marker due to half turn free spool adjustment

BEARINGS: 2 + 1 | **OSCILLATION:** 2 Speed + Aero Wrap

	g	Ratio	Line	Retrieval	Spool	RD
ALX10000XTB	645	4.6:1	0.40mm-300m	100	15	RD17909
ALX10000XTBSP	650	5.3:1	0.40mm-300m	115	15	RD17921



AERLEX XSB

- Heavy duty sea reel that is perfectly suited to surf casting
- SHIMANO's Instant Drag allows for quick adjustment of the drag for locking up on powerful casts
- Aero Wrap line lay and an AR-C spool for good casting performance
- A high torque retrieve ratio of 4.6:1 gives the reel power to cope with heavy leads and rough ground

BEARINGS: 2 + 1 | **OSCILLATION:** 2 Speed + Aero Wrap

	g	Ratio	Line	Retrieval	Spool	RD
ALX10000XSB	645	4.6:1	0.40mm-300m	100	15	RD17892



BeastMaster XB

- Heavy duty sea reel that is perfectly suited to surf casting as well as carp fishing
- SHIMANO's Instant Drag allows for quick adjustment of the drag for locking up on powerful casts
- Aero Wrap line lay and an AR-C spool for good casting performance
- A high torque retrieve ratio of 4.6:1 gives the reel power to cope with heavy leads and rough ground

BEARINGS: 1 + 1 | **OSCILLATION:** 2 Speed + Aero Wrap

	g	Ratio	Line	Retrieval	Spool	RD
BMBP10000XB	705	4.6:1	0.35mm-400m	100	15	RD18787



BAITRUNNER REELS

The SHIMANO BAITRUNNER Freespool system was developed over 30 years ago and has become the first choice for many carp and specimen anglers throughout the world.

BAITRUNNER is a registered trade mark of SHIMANO and can not be used by any other company.

46	BAITRUNNER Ci4+ XTB LC
48	BAITRUNNER XTB LC
49	BAITRUNNER X-Aero RA
	BAITRUNNER D
50	BAITRUNNER OC
	BAITRUNNER XT RB
51	BAITRUNNER DL RB
	BAITRUNNER DL FB
52	BAITRUNNER ST RB
	BAITRUNNER ST FB

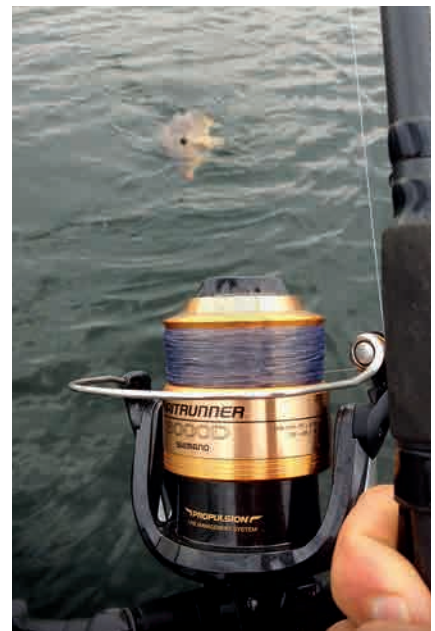
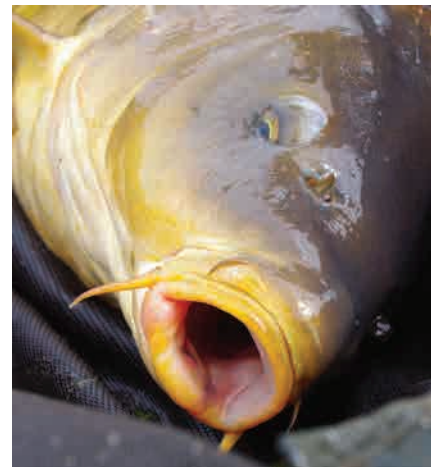

THE LEGEND GOES ON

BAITRUNNER C14+ XTB-LC

- The oversized, lightweight C14+ BAITRUNNER reel provides a massive weight saving, bringing it into the high-end Big Pit performance casting category
- Unsurpassed X-SHIP technology makes the reel ultra smooth and delivers enormous cranking power even under extreme pressure
- Aero Wrap combined with Slow Speed oscillation provides excellent line lay for easier and longer casting
- AR-C spool for increased casting performance
- Instant Drag spool for fish-playing control
- Features a stamping bail to eliminate line wrap
- Line retrieve per handle turn: Medium - 105cm, Big - 110cm

SIZES: Medium & Big

BEARINGS: 6 + 1

OSCILLATION: Two-speed Slow Speed Oscillation plus Aero Wrap

HANDLE: Screw in Single Aluminium

SPARE SPOOL: 1 x Cold Forged Aluminium



SPOOL REDUCER BIG

3500 - Shallow line reducer x2	0.20mm-200m
10000 - Shallow line reducer x2	0.40mm-300m

SPOOL REDUCER MEDIUM

3500 - Shallow line reducer x2	0.20mm-200m
4500 - Shallow line reducer x2	0.35mm-220m

MBTRC14XTBLC	510	5.3:1	0.40mm-210m	105	15	RD18814
BBTRC14XTBLC	640	4.6:1	0.35mm-550m	110	20	RD18515





REEL TECHNOLOGY

FRONT DRAG REELS

REAR DRAG REELS

BIG PIT REELS

BAITRUNNER REELS

BAITCASTING REELS

SALTWATER REELS

MULTIPLIERS

MINIMAL FRICTION

BAITRUNNER XTBL-*LC*

- A large AR-C spool system with Slow oscillation in combination with the Aero Wrap II line lay system ensures maximum distance casting performance
- X-SHIP system for a smooth power transfer and stability of the gears thanks to the two-point support of the pinion gear by ball bearings
- The gears have been redesigned to minimise friction and increase power transfer from the long aluminum handle to the rotor. This delivers more torque and winding power making fish playing easier and delivering more control
- Available in two sizes: the big size is perfect for the larger carp waters whilst the medium version is the ideal choice for medium sized waters where casting distance is not the most important requirement

SIZES: Medium and Big

BEARINGS: 4 + 1

OSCILLATION: Slow Speed Oscillation plus Aero Wrap

HANDLE: Screw in Single Aluminium



SPOOL REDUCER BIG

3500 - Shallow line reducer x1	0.20mm-200m
10000 - Shallow line reducer x1	0.40mm-300m

SPOOL REDUCER MEDIUM

3500 - Shallow line reducer x1	0.20mm-200m
4500 - Shallow line reducer x1	0.35mm-220m

MBTRXTBLC	560	5.3:1	0.35mm-290m	105	15	RD18394
BBTRXTBLC	720	4.6:1	0.40mm-400m	110	20	RD18426





BAITRUNNER X-AERO

- BAITRUNNER reel with oversized large diameter Aero Concept spool for increased casting performance
- Available in 6000, 8000, 10000 sizes
- 8000 and 10000 sizes have single handle for increased power, 6000 size has balanced double handle
- 4.6:1 gear ratio delivers increased winding power
- Aero Wrap and 2-speed oscillation provides outstanding line lay
- 10000 size retrieves 99cm line per handle turn, sizes 6000 and 8000 retrieve 96cm

SIZES: 6000, 8000, 10000

BEARINGS: 6 + 1 (8000, 10000) 8 + 1 (6000)

OSCILLATION: Two-speed Slow Speed Oscillation plus Aero Wrap

HANDLE: Single Aluminium / Double Handle (6000)

SPARE SPOOL: 1 x Cold Forged Aluminium



	g	⚙️	📏	🌀	🔧	🗑️
BTXAR6000RA	615	4.6:1	0.30mm-320m	96	5	RD16700
BTXAR8000RA	580	4.6:1	0.35mm-290m	96	5	RD16731
BTXAR10000RA	590	4.6:1	0.40mm-260m	99	5	RD16735

BAITRUNNER D

- An extremely powerful and robust front drag BAITRUNNER available in a range of sizes to suit most applications
- Other features include cold forged Aluminium spool and gear, waterproof drag, one piece bail and a maintenance port

SIZES: 4000, 6000, 8000, 12000

BEARINGS: 3 + 1

OSCILLATION: Varispeed

HANDLE: Single Aluminium



	g	⚙️	📏	🌀	🔧	🗑️
BTR4000D	385	4.8:1	0.35mm-130m	71	7	RD13525
BTR6000D	570	4.8:1	0.40mm-140m	89	9	RD13238
BTR8000D	615	4.8:1	0.40mm-230m	91	9	RD13196
BTR12000D	850	4.4:1	0.40mm-320m	93	12	RD13575
BTR6000DEU (EU)	550	4.8:1	0.40mm-140m	89	9	RD13238
BTR8000DEU (EU)	600	4.8:1	0.45mm-230m	91	9	RD13196



BAITRUNNER OC

- An affordable heavy duty BAITRUNNER
- AR-C spool with Varispeed line lay for improved casting performance
- Dynabalance reduces reel wobble
- 12000 size suitable for catfish, 8000 and 6000 for carp and 4000 for barbel and bass
- Line retrieve per handle turn: size 4000 - 71cm, size 6000 - 89cm, size 8000 - 91cm, size 12000 - 93cm

SIZES: 4000, 6000, 8000, 12000

BEARINGS: 3 + 1

OSCILLATION: Varispeed II

HANDLE: Single



BTR4000OC	380	4.8:1	0.35mm-130m	71	7	RD15103
BTR6000OC	545	4.8:1	0.40mm-140m	89	9	RD15112
BTR8000OC	590	4.8:1	0.40mm-230m	91	9	RD15123
BTR12000OC	825	4.8:1	0.45mm-240m	93	12	RD15133

BAITRUNNER XT

- Stunning understated black cosmetics with additional chrome detailing
- Aero Wrap and 2-speed oscillation providing outstanding line lay for smoother and longer casting
- AR-C spool for increased casting performance
- Hybrid XT-7 and Aluminium body for strength and reduced weight
- Dynabalance gives excellent balance when retrieving at high speed
- Line retrieve per handle turn: size 6000 - 85cm, size 8000 - 87cm, size 10000 - 88cm

SIZES: 6000, 8000, 10000

BEARINGS: 4 + 1

OSCILLATION: 2 Speed Oscillation + Aero Wrap II

HANDLE: Double

SPARE SPOOL: 1 x Cold Forged Aluminium



BTRXT6000RB	610	4.6:1	0.30mm-320m	85	6	RD15213
BTRXT8000RB	610	4.6:1	0.35mm-290m	87	6	RD15223
BTRXT10000RB	610	4.6:1	0.40mm-260m	88	6	RD15227



BAITRUNNER DL

- Understated graphics designed for the specimen angler
- Powerful 4.6:1 gear ratio for excellent fish-playing control
- Balanced double handle on both models
- AR-C cold forged aluminum spool
- Varispeed oscillation produces excellent line lay
- Line retrieve per handle turn: size 6000 - 85cm, size 10000 - 87cm

SIZES: 6000, 10000

BEARINGS: 3 + 1

OSCILLATION: Varispeed II

HANDLE: Double

SPARE SPOOL: 1 x XT-7



BAITRUNNER DL

- XT-7 body and rotor keeps body weight to a minimum
- Double handle gives excellent balance and superb winding power
- 4.8:1 retrieve ratio and diecast gear for extra power and torque
- Line retrieve per handle turn: size 2500 - 68cm, size 4000 - 75cm
- Ideally suited to smaller specimen and specialist angling applications, including carp and barbel fishing as well as deadbaiting for predatory species

SIZES: 2500, 4000

BEARINGS: 3 + 1

OSCILLATION: Varispeed II

HANDLE: Double

SPARE SPOOL: 1 x XT-7



Model	Weight (g)	Gear Ratio	Line Capacity (mm-m)	Retrieval (cm)	Spool	Part No.
BTRDL6000RB	590	4.6:1	0.30mm-270m	85	6	RD17086
BTRDL10000RB	595	4.6:1	0.35mm-350m	87	6	RD17091

Model	Weight (g)	Gear Ratio	Line Capacity (mm-m)	Retrieval (cm)	Spool	Part No.
BTRDL2500FB	360	4.8:1	0.25mm-160m	68	3	RD17056
BTRDL4000FB	415	4.8:1	0.30mm-180m	75	6	RD17063



BAITRUNNER ST

- Entry-level BAITRUNNER reel in 6000 and 10000 size
- Balanced double handle on both models
- XT-7 body and rotor with understated black cosmetics
- 4.6:1 gear ratio delivers extra winding power
- Super Stopper II for instant and infinite anti-reverse
- Line retrieve per handle turn: size 6000 - 85cm, size 10000 - 87cm

SIZES: 6000, 10000

BEARINGS: 1 + 1

OSCILLATION: Varispeed II

HANDLE: Double



	g	Ratio	Line	Ret	Sp	RD
BTRST6000RB	550	4.6:1	0.30mm-270m	85	6	RD16818
BTRST10000RB	555	4.6:1	0.35mm-350m	87	6	RD16822

BAITRUNNER ST

- Very affordable, entry-level small BAITRUNNER suited to commercial fisheries and all specialist angling
- Varispeed oscillation results in excellent line lay for better casting and smoother fish playing drag
- Super Stopper II technology eliminates any fall back of the reel handle when setting tips
- XT-7 body and rotor keeps weight to a minimum
- Line retrieve per handle turn: size 2500 - 68cm, size 4000 - 75cm

SIZES: 2500, 4000

BEARINGS: 1 + 1

OSCILLATION: Varispeed II

HANDLE: Single



	g	Ratio	Line	Ret	Sp	RD
BTRST2500FB	310	4.8:1	0.25mm-160m	68	3	RD16826
BTRST4000FB	355	4.8:1	0.35mm-130m	75	6	RD16830



BAITCASTING REELS

Baitcasting reels are increasing in popularity as more anglers turn to predator fishing throughout Europe. Lightweight design, combined with exceptionally direct contact make working lures with a Baitcaster or a small multiplier type reel extremely efficient and rewarding. Almost all SHIMANO low and round profile baitcasting reels now feature casting control technology for trouble free use.



ROUND PROFILE

- 57 OCEA CONQUEST
- 58 CALCUTTA CONQUEST
- 60 CARDIFF A
- 61 CORVALUS

LOW PROFILE

- 62 METANIUM DC
- 63 CURADO DC · SLX DC
- 64 ALDERBARAN MGL
- 65 METANIUM MGL · BANTAM MGL
- 66 CURADO MGL · SLX MGL
- 67 CURADO 201 · SLX XT
- 68 GRAPPLER BB
- 69 ALDERBARAN BFS XG
- 70 TRANX · CURADO 301
- 71 SLX · CAIUS
- 72 GENPU XT

BRAKE SYSTEMS

THE SETTING OF THE SPOOL BRAKE SYSTEM IS OF GREAT IMPORTANCE WHEN FISHING WITH BAITCASTING REELS. SHIMANO OFFER FOUR DIFFERENT OPTIONS OF SPOOL BRAKE SYSTEMS, I-DC, SVS, FTB AND VBS TO CONTROL THE RESISTANCE ON THE SPOOL DURING CASTING.

DC BRAKE
Automatic control of braking force by detecting spool revolution

.....
CONVENTIONAL BRAKING SYSTEM
Braking force changes according to spool rotation speed

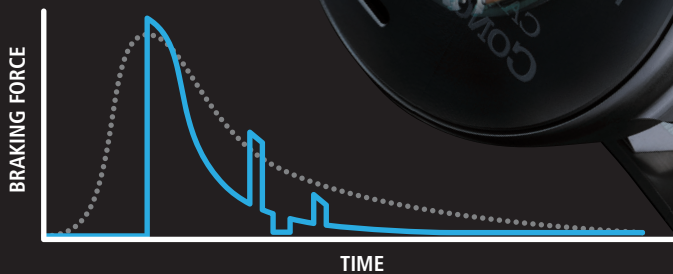

DC BRAKE IMPROVES INTERMITTENT BRAKING.

DC is a highly advanced digital control system which generates its own electricity to power a micro-computer. This calculates spool rotation at 1000 times per second and makes adjustments to the spool rotational resistance during the cast preventing over-runs or excessive braking. The revolutionary system features a magnet set in the spool shaft which generates electricity when rotating inside the copper coil placed in the reel body. Braking force is instantaneously controlled from 0 to 100%. Batteries are not necessary as the micro-computer generates power.

 **I-DC5** - A broad selection of 3 internal modes and 5 external dial settings.

 **I-DC4** - An easy to use, 4 settings, externally adjustable brake dial.





LIGHTWEIGHT SPOOL DESIGN FOR LONGER SPOOL ROTATION

SVS INFINITY is a centrifugal braking system that uses small weights on the inside of the roller. The usual brake settings can be selected with the external brake controller. For additional and even finer gradation, the inner weights can be additionally switched on or off in order to reduce or increase the braking resistance.

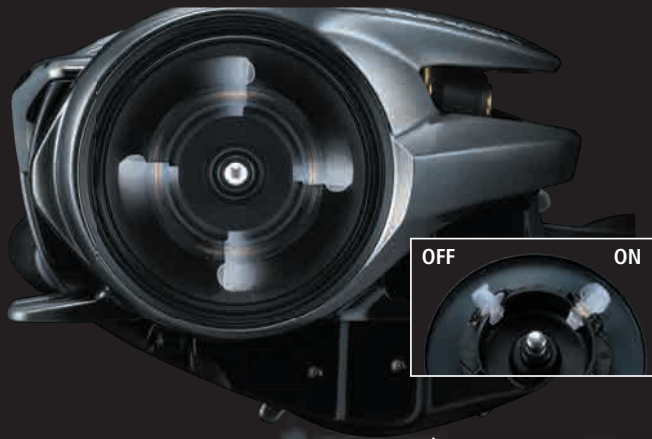

SHIMANO'S ORIGINAL BRAKE SYSTEM, THE LIGHTEST SPOOL IN SHIMANO BAIT FINESSE SERIES

FTB (FINESSE TUNE BRAKE SYSTEM) is designed for ultra lightweight finesse fishing and uses a magnet moving mechanism that is mounted on the internal frame of the reel not the spool. This enables the spool to move with almost no friction, making the use of ultra-light lures possible. Adjustment can be made using an external dial.

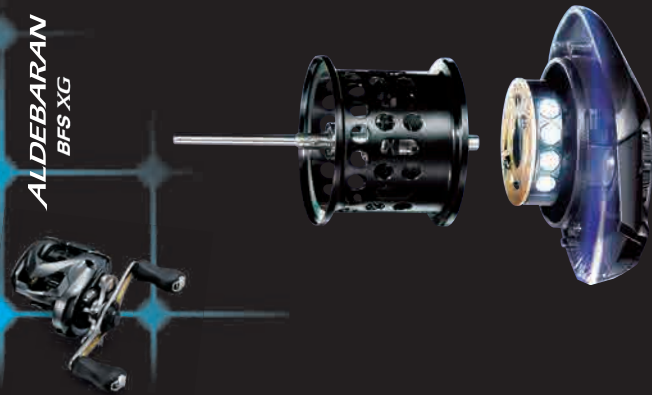

DESIGNED TO HELP PREVENT BACKLASH WITH YOUR REEL

VBS (VARIABLE BRAKE SYSTEM) is designed to slow the spool down as your lure loses momentum after casting. The VBS systems acts as a centrifugal break using the distribution of weight to create drag on the spool. This feature is designed to help prevent backlashes with your reel.





MAGNUMLITE SPOOL

2ND GENERATION MAGNUMLITE SPOOL

MAGNUMLITE SPOOL
 LIGHTWEIGHT SPOOL DESIGN FOR LONGER SPOOL ROTATION

Magnumlite Spool is a lightweight spool design that reduces the inertia (force) required to rotate the spool. This is especially useful when casting and noticeably increases casting distance, especially with lightweight lures. The latest version Magnumlite Spool III is used on the new Metanium MGL.



CORESOLID BODY

A METAL MOULDED BODY THAT COMBINES HIGH RIGIDITY AND COMPACT SIZE.

Normally, level wind protector and side plate are made separately from the frame. These are now integrally molded with metal. It boasts high rigidity and achieves a compact body size that makes it easier for pairing. A strong body achieves a stable winding when fighting big fish and with high reliability, can handle powerful fights with confidence.



S3D (STABLE SPOOL DESIGN)

SHIMANO's **S3D** technology leads to significantly reduced spool vibration. By designing a balanced and uniform thin wall aluminium constructed spool, S3D creates an incredibly smooth feeling when casting and retrieving lures.



POWERFUL & LIGHT WINDING

INFINITYDRIVE

INFINITYDRIVE produces stronger and lighter winding by repositioning the support bearings on the pinion shaft and optimizing the gearing position for maximum resistance reduction.

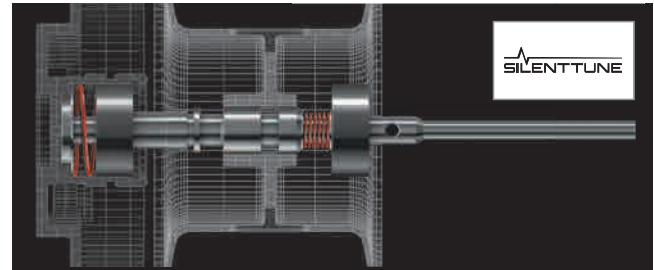

SILENT TUNE

SILENT TUNE is a new SHIMANO technology. As with any casting reel, the spool rides on bearings. These bearings have pockets in the frame or side plates which house the bearings and are given some tolerance in order to make the bearings more easily changeable. While the tolerance is necessary, it allows the bearings to move slightly during casting leading to the smallest of vibrations that focus energy away from the core of the reel and reduce the distance and smoothness of the cast. Silent Tune technology is SHIMANO's answer to this issue. They engineered a method to add small springs under the bearings which keep the bearings in place ensuring proper alignment and eliminating any movement or vibration that may occur.



SUPER FREE SPOOL

SUPER FREE SPOOL SYSTEM (SF) - SF was designed to eliminate friction on the spool shaft during the cast. In standard baitcasting reels, when the clutch bar is pressed down, the pinion gear is freed and can drag on the spool shaft creating friction that can limit the length of a cast. With SF, the pinion gear is supported by a ball bearing so that when the clutch is disengaged in preparation for a cast, the pinion gear and spool shaft are kept in perfect alignment.

THE NEW FLAGSHIP

NEW

OCEA CONQUEST

- New flagship round baitcasting reel
- HAGANE Body combined with MicroModule gearing and X-SHIP for durable, super smooth performance
- Advanced Cross Carbon Drag plus Exciting Drag Sound system
- Level Wind system prevents 'bedding in' of braid on the spool for smoother casting
- S Compact Body for easy handling with lighter rods
- Ideal for medium to large lure fishing and also lightweight trolling in both fresh and saltwater environments
- SVS and Super Free Spool casting control on smaller 201 model

SIZES: 201, 301

BEARINGS: 12 + 1 (201)
10 + 1 (301)

HANDLE:

(201) Double aluminum

(301HG) Single aluminum with EGG-shape knob

(301PG) Single aluminum Power handle



	9	10	11	12	13	14
OCCNQ201PG	275	4.8:1	PE2-200m	60	6	-
OCCNQ301HG	345	6.2:1	PE3-200m	84	7	-
OCCNQ301PG	340	4.8:1	PE3-200m	65	8	-



REEL TECHNOLOGY

FRONT DRAG REELS

REAR DRAG REELS

BIG PIT REELS

BAITRUNNER REELS

BAITCASTING REELS

SALTWATER REELS

MULTIPLIERS

SMALL & PERFECT

CALCUTTA CONQUEST

- MicroModule gearing, in combination with X-SHIP, 12 ball bearings and a roller bearing delivers remarkable smoothness and positive control
- SVS breaking system for accurate casting control
- Fitted with Exciting Drag Sound system which sounds fantastic and is useful when trolling
- Synchronized level wind prevents 'bedding in' of braid on the spool for smoother casting
- Ideal for medium to extra large lure fishing and also lightweight trolling
- Saltwater proof

SIZES: 301

BEARINGS: 12 + 1

HANDLE: Double Handle with Paddles



	9	12	14	16	18	20
CTCNQ300A *	330	6.2:1	0.25mm-255m	84	7	BNT6029
CTCNQ301A	330	6.2:1	0.25mm-255m	84	7	BNT6029
CTCNQ400A *	340	6.2:1	0.30mm-235m	84	7	-

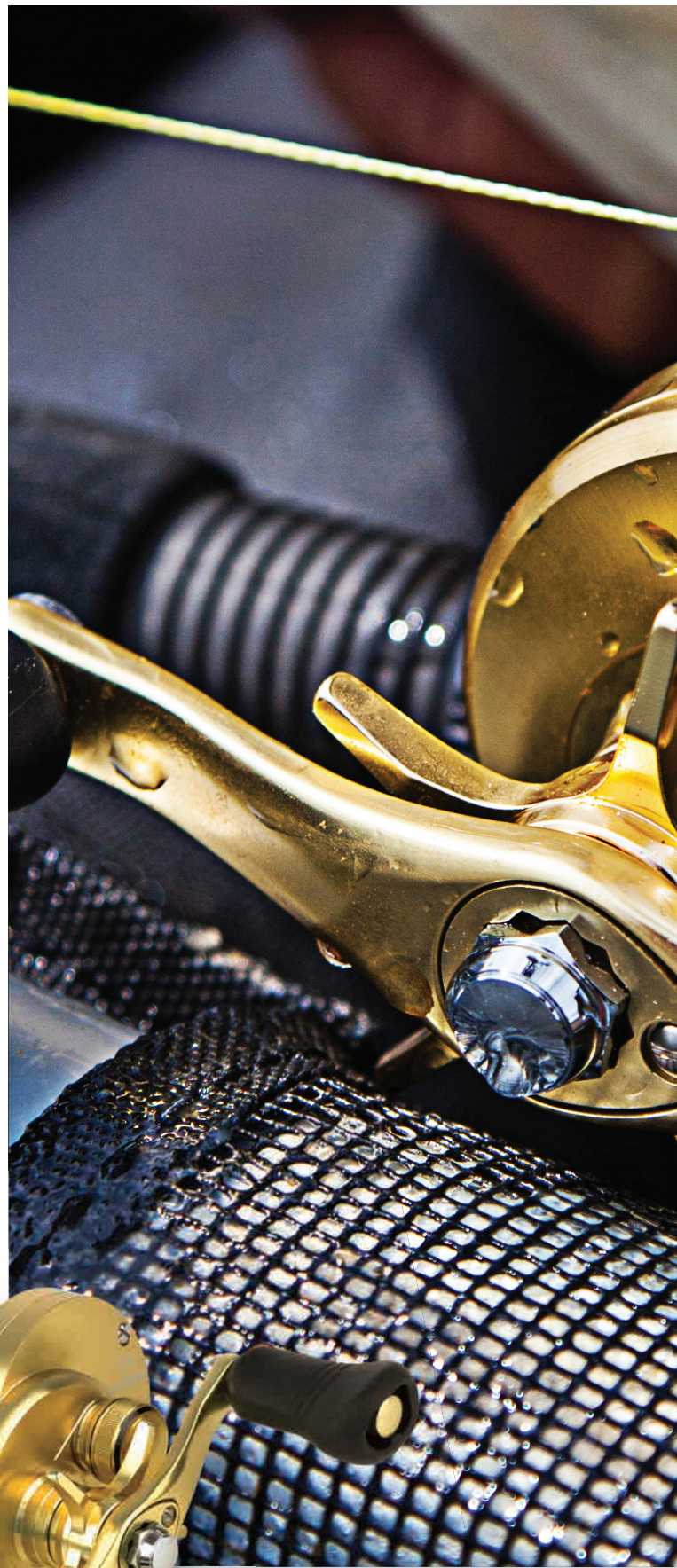

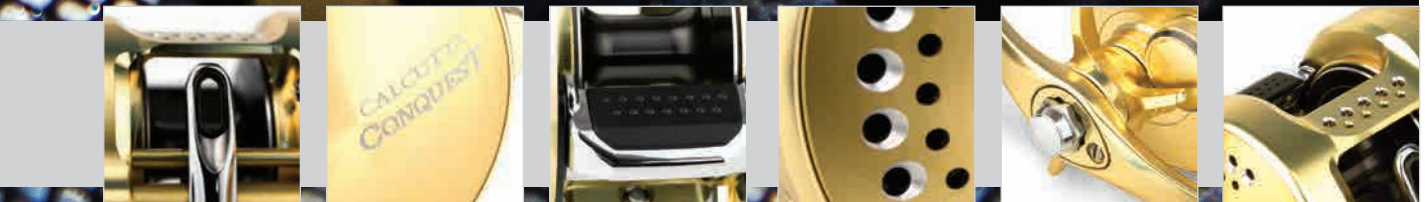

COMPLETE CONTROL

CARDIFF

- An easy-to-use left hand multiplier
- Ideal for freshwater trolling or casting medium to heavy lures
- Complete casting control is achieved thanks to SHIMANO's Variable Brake System (VBS)
- Level-wind system distributes line evenly across the spool
- Die-cast aluminium frame and machined aluminium spool offer exceptional strength
- 5.8:1 gear ratio and 4 A-RB bearings make the reel suited to fishing lures that require a high speed retrieve

SIZES: 201, 301, 401

BEARINGS: 4 + 1

HANDLE: Double Handle with Paddles



CDF201A	230	5.8:1	0.25mm-255m	61	5	BNT3303
CDF301A	252	5.8:1	0.30mm-235m	61	5	BNT3318
CDF401A	337	5.2:1	0.35mm-270m	56	5	BNT3102



INSTANT CASTING

CORVALUS

- An easy-to-use left-hand multiplier with built in level-wind
- Ideal for freshwater trolling or casting medium to heavy lures
- Fully adjustable Variable Brake System (VBS) keeps overruns to a minimum
- Ergonomic thumb bar spool release allows instant casting to moving targets

SIZE: 401

BEARINGS: 3 + 1

HANDLE: Double Handle with Paddles



CVL401

335 5.2:1 0.35mm-270m 56 5 BNT3195



ULTIMATE CONTROL

Metanium DC

- Very low weight baitcasting reel with magnesium HAGANE Body, perfect for lures ranging from as light as 5g up to as large as 30g crankbaits
- Highly advanced I-DC5 digital control system for the ultimate in casting control - 15 different settings based on either the line type or lure weight
- MicroModule and X-SHIP gearing delivers remarkable smoothness combined with ultra positive operation
- S3D Spool for reduced vibration when casting
- Auto casting adjustment functions
 1. Big lures (18-30g)
 2. Medium lures (10-20g)
 3. Small lures (8-12g)
 4. Finesse lures (5-8g)

A. Auto function DC system can decide the optimal brake strength setting

SIZES: 101

BEARINGS: 9 + 1

HANDLE: Double Handle with Paddles



	9	9	9	9	9	9
METDC100HG *	190	7.4:1	0.25mm-150m	79	5	BNT5979
METDC101HG	190	7.4:1	0.25mm-150m	79	5	BNT5979
METDC101XG	195	8.5:1	0.25mm-150m	91	5	BNT5979





CURADO DC

- Advanced I-DC4 digital control system for the ultimate in casting control
- MicroModule and X-SHIP gearing delivers remarkable smoothness combined with ultra positive operation
- Maximum drag setting of 5kg for controlling large fish
- Auto casting adjustment functions
 1. Max Distance mode: Best for calm conditions
 2. Braid/mono mode: All-round setting for braid or mono
 3. Fluorocarbon mode: All-round setting for fluorocarbon
 4. Skipping mode: stronger braking when skipping baits

SIZES: 151

BEARINGS: 6 + 1

HANDLE: Double Handle with Paddles



	9	10	11	12	13	14
CUDC150 *	220	6.2:1	0.33mm-100m	66	5	BNT5900
CUDC151	220	6.2:1	0.33mm-100m	66	5	BNT5900
CUDC151HG	220	7.4:1	0.33mm-100m	79	5	BNT5900
CUDC151XG	225	8.5:1	0.33mm-100m	91	5	BNT5900

SLX DC

- Advanced i-DC4 digital control baitcasting reel designed for small to large lures
- Four digital settings control the cast instantly and can be set for maximum distance, braid and mono line, fluorocarbon line and skipping
- No batteries are required, the spool rotation creates electricity to power the micro computer
- HAGANE Body for lightweight strength
- S3D Spool for reduced vibration when casting
- Level wind for trouble free line lay
- Available in three different speed versions to suit personal preference

SIZES: 151

BEARINGS: 4 + 1

HANDLE: Double Handle with Paddles



	9	10	11	12	13	14
SLXDC150 *	215	6.3:1	10mm-120m	67	5.5	BNT6359
SLXDC151	215	6.3:1	10mm-120m	67	5.5	BNT6359
SLXDC151HG	215	7.2:1	10mm-120m	77	5	BNT6359
SLXDC151XG	215	8.2:1	10mm-120m	88	5	BNT6359

ULTRA LIGHT

ALDEBARAN MGL

- Very light baitcasting reel with Magnesium HAGANE Body, designed for ultra light finesse fishing styles
- Ultra light MGL spool has very low start inertia for improved distance casting and accuracy with light lures
- High drag setting of up to 4.5kg for maximum playing control of large fish
- X-SHIP gearing delivers efficient power transfer from the handle to the spool
- S3D Spool for reduced vibration when casting

SIZES: 51

BEARINGS: 9 + 1

HANDLE: Double Handle with Paddles



ALDMGL51	135	6.5:1	0.25mm-100m	65	4.5	BNT5876
ALDMGL51HG	135	7.4:1	0.25mm-100m	74	4.5	BNT5876





NEW

Metanium MGL

- Magnesium Coresolid Body for extra durability, rigidity and high-end lightweight performance
- Advanced MGL III spool reduces casting inertia by 17% for improved casting performance
- Micromodule drive gear for enhanced durability and long term smoothness
- New design Ci4+ lightweight star drag
- SVS Infinity braking system for ultimate adjustability
- SHIMANO Silent Tune for reduced spool bearing vibration

SIZE: 151

BEARINGS: 10 + 1

HANDLE: Double Handle with Paddles



	g	Ratio	Line	Ret	Spool	Drag
METMGL151B	180	6.2:1	0.33mm-100m	66	5	-
METMGL151HGB	180	7.1:1	0.33mm-100m	76	5	-
METMGL151XGB	185	8.1:1	0.33mm-100m	86	5	-

Bantam MGL

- Aluminium Coresolid HAGANE Body provides a very solid frame
- New SVS Infinity breaking system can be set very accurately for casting both heavy and very light lures
- MicroModule Gear and X-SHIP deliver extreme smooth performance with maximum winding efficiency
- 5kg maximum drag ideal for larger fish
- Can be used in saltwater

SIZE: 151

BEARINGS: 8 + 1

HANDLE: Double Handle with Paddles



	g	Ratio	Line	Ret	Spool	Drag
BANTMGL151	215	6.2:1	0.33mm-100m	66	5	BNT5805
BANTMGL151HG	220	7.1:1	0.33mm-100m	76	5	BNT5805
BANTMGL151XG	225	8.1:1	0.33mm-100m	86	5	BNT5805



NEW

CURADO MGL

- The smallest Curado model available, developed for efficient casting of smaller lures
- Lightweight Ci4+ Body
- MicroModule Gear and X-SHIP deliver extreme smooth performance with maximum winding efficiency
- Advanced MGL III spool reduces casting inertia by 17% for improved casting performance
- SVS infinity braking system controls spool speed for precision casting
- S3D Spool for reduced vibration when casting
- Powerful Cross Carbon Drag

SIZES: 71

BEARINGS: 8 + 1

HANDLE: Double Handle with Paddles



	g	Ratio	Line	Length	Retr.	Drag
CUMGL71HGK	195	7.4:1	0.285mm-100m	74	5.5	-
CUMGL71XGK	195	8.1:1	0.285mm-100m	81	5.5	-



NEW

SLX MGL

- The latest version of the hugely popular SLX range
- HAGANE Body for lightweight strength
- Advanced MGL III spool reduces casting inertia by 17% for improved casting performance
- SVS infinity braking system controls spool speed for precision casting
- S3D Spool for reduced vibration when casting
- Level wind for trouble free line lay
- Three different speed options to suit all preferences - standard 6.3:1, fast 7.2:1 and extra fast 8.2:1

SIZES: 71

BEARINGS: 4 + 1

HANDLE: Double Handle with Paddles



	g	Ratio	Line	Length	Retr.	Drag
SLXMGL70HG *	200	7.2:1	0.285mm-100m	72	5.5	-
SLXMGL71HG	200	7.2:1	0.285mm-100m	72	5.5	-
SLXMGL71XG	200	8.2:1	0.285mm-100m	82	5.5	-

PRECISION CASTING

NEW MODEL

CURADO

- Successor of well-known Curado 201 I featuring Micromodule Gear system and the Stable Spool design
- SVS infinity braking system controls spool speed for precision casting
- Designed to fit the needs of freshwater predator fisherman but also able to withstand tough saltwater conditions
- A true allrounder to cast bigger lures and fight big fish. It will fit perfectly for pike and big blackbass fishing with medium sized lures

SIZE: 201

BEARINGS: 6 + 1

HANDLE: Double Handle with Paddles



	g	Ratio	Line	Ret	Spool	
CU200K *	215	6.2:1	0.20mm-225m	66	5	BNT5675
CU201K	215	6.2:1	0.20mm-225m	66	5	BNT5675
CU201PGK	220	5.0:1	0.20mm-225m	53	5	- NEW
CU201HGK	215	7.4:1	0.20mm-225m	79	5	BNT5675



REEL TECHNOLOGY

FRONT DRAG REELS

REAR DRAG REELS

BIG PIT REELS

BAITRUNNER REELS

BAITCASTING REELS

SALTWATER REELS

MULTIPLIERS



GRAPPLER

- Lightweight Ci4+ body
- Perfect for light jigging
- Weighs only 185g for reduced fatigue and increased jig control
- SVS braking system for advanced casting control
- Long crank (51mm) power handle

SIZES: 71

BEARINGS: 4 + 1

HANDLE: Double Handle with Paddles



16GRAPBB201HG

185 7.2:1 0.20mm-225m 77 5.5 03566-0075



SLX XT

- Mid-entry price level reel perfect for all-round fishing
- Lightweight, compact, aluminium HAGANE Body
- Long handle 45/48mm for extra control
- S3D Spool for reduced vibration when casting
- Level wind for trouble free line lay
- XT version has new SVS Infinity brake control, with external adjustment dial
- Lightweight aluminium spool
- Available in three different speed versions to suit personal preference

SIZES: 151

BEARINGS: 4 + 1

HANDLE: Double Handle with Paddles



SLXXT150 *	205	6.3:1	0.25mm-150m	63	5.5 BNT5959
SLXXT151	205	6.3:1	0.25mm-150m	63	5.5 BNT5959
SLXXT151HG	205	7.2:1	0.25mm-150m	72	5 BNT5959
SLXXT151XG	205	8.2:1	0.25mm-150m	82	5 BNT5959

SUPREME POWER

ALDEBARAN BFS XG

- Lightweight magnesium HAGANE body with C14+ side plates
- X-SHIP gearing for supreme efficient power transfer
- S3D Spool for reduced vibration when casting
- FTB (Finesse Tune Brake System). SHIMANO's lightest brake adjustment system for optimum casting of ultra light lures

SIZES: XG

BEARINGS: 9 + 1

HANDLE: Double Handle with Paddles



5RH941000

| 130 8.0:1 0.23mm-50m 80 3.5 03008-0077





TRANX

- Suitable for freshwater or saltwater use
- Perfect for casting big baits and catching big fish
- Max drag power over 10kg!
- CoreProtect provides long lasting durability in the harshest environments
- S3D Spool with for ultra light rotation and reduced vibration
- Possible to order separate double handle for HG models: BNT5527

SIZES: 301, 401

BEARINGS: 5 + 1

HANDLE: Double Handle with Paddles (301A, 401A),
Single Handle with big knob (301HGA, 401 HGA)



	g	Ratio	Line	Ret	Spool	Handle
TRX300A *	330	5.8:1	0.30mm-235m	75	10	BNT5522
TRX301A	330	5.8:1	0.30mm-235m	75	10	BNT5522
TRX301HGA	330	7.6:1	0.30mm-235m	100	8	BNT5522
TRX400A *	340	5.8:1	0.30mm-270m	75	10	BNT5619
TRX401A	340	5.8:1	0.30mm-270m	75	10	BNT5619

NEW

CURADO

- 300 size is the largest Curado model available and has been developed to handle the biggest freshwater fish
- Lightweight aluminium HAGANE Body for strength
- X-SHIP gearing for efficient power transfer
- VBS braking system for precise casting control
- Powerful Cross Carbon Drag to control large fish
- Level wind for trouble free line lay
- S3D Spool with for ultra light rotation and reduced vibration

SIZE: 301

BEARINGS: 5 + 1

HANDLE: Double Handle with Paddles



	g	Ratio	Line	Ret	Spool	Handle
CU300K *	300	4.7:1	0.30mm-235m	63	10	-
CU301K	300	4.7:1	0.30mm-235m	63	10	-
CU301HGK	305	6.6:1	0.30mm-235m	88	8	-



SLX

- Excellent combination of quality and cost, with lightweight aluminium HAGANE Body
- Long handle 45/48mm for extra control
- S3D Spool for reduced vibration when casting
- Level wind for trouble free line lay
- Available in three gear ratios (including extra fast 8.2:1) to suit personal preference

SIZE: 151

BEARINGS: 3 + 1

HANDLE: Double Handle with Paddles



CAIUS

- Entry level baitcasting reel, perfect for anglers who are new to baitcasting reels
- XT-7 high strength resin body
- Level wind for trouble free line lay
- Maximum drag setting 5kg to overcome the largest freshwater predators
- Lightweight aluminium spool

SIZE: 151

BEARINGS: 3 + 1

HANDLE: Double Handle with Paddles



	g	Ratio	Line	Ret	Spool	Part No
SLX150 *	195	6.3:1	0.25mm-150m	63	5	BNT5959
SLX151	195	6.3:1	0.25mm-150m	63	5	BNT5959
SLX151HG	195	7.2:1	0.25mm-150m	72	5	BNT5959
SLX151XG	195	8.2:1	0.25mm-150m	82	5	BNT5959

	g	Ratio	Line	Ret	Spool	Part No
CIS151HGB	210	7.2:1	10mm-120m	76	5	BNT5412

UNRIVALLED VALUE

NEW

GENPU XT

- Developed for a wide variety of boat fishing applications such as Tai rubber (Engetsu) jigging and light jigging
- Strong, lightweight XT-7 composite body
- Shielded AR-B bearings for trouble free performance
- Level wind for precise line lay
- Power handle and Ci4+ grip for angler comfort and control
- Unrivalled value for money

SIZES: 200, 201

BEARINGS: 3 + 1

HANDLE: Single Power Handle with Ci4+ round knob



GNPXT200PG	195	5.5:1	0.25mm-185m	59	5.5	-
GNPXT201PG	195	5.5:1	0.25mm-185m	59	5.5	-





SALTWATER REELS

Saltwater fishing can be extremely severe and saltwater intrusion into the inside of a reel can cause serious performance problems. Therefore it is imperative to enhance water resistance without impairing the properties of spinning reels designed for saltwater fishing.

SHIMANO achieve this by using X-Shield for body protection and X-Protect for rotor protection. Also, the pressure put on the gearing during extreme use can also create problems with wear and even failure. The use of SHIMANO HAGANE gearing ensures that maximum performance is maintained at all times.

These technologies can be found on many of SHIMANO's latest models.

76	STELLA SW-C
78	TWINPOWER SW-B
79	SARAGOSA SW-A
80	SPHEROS SW
	SOCORRO SW

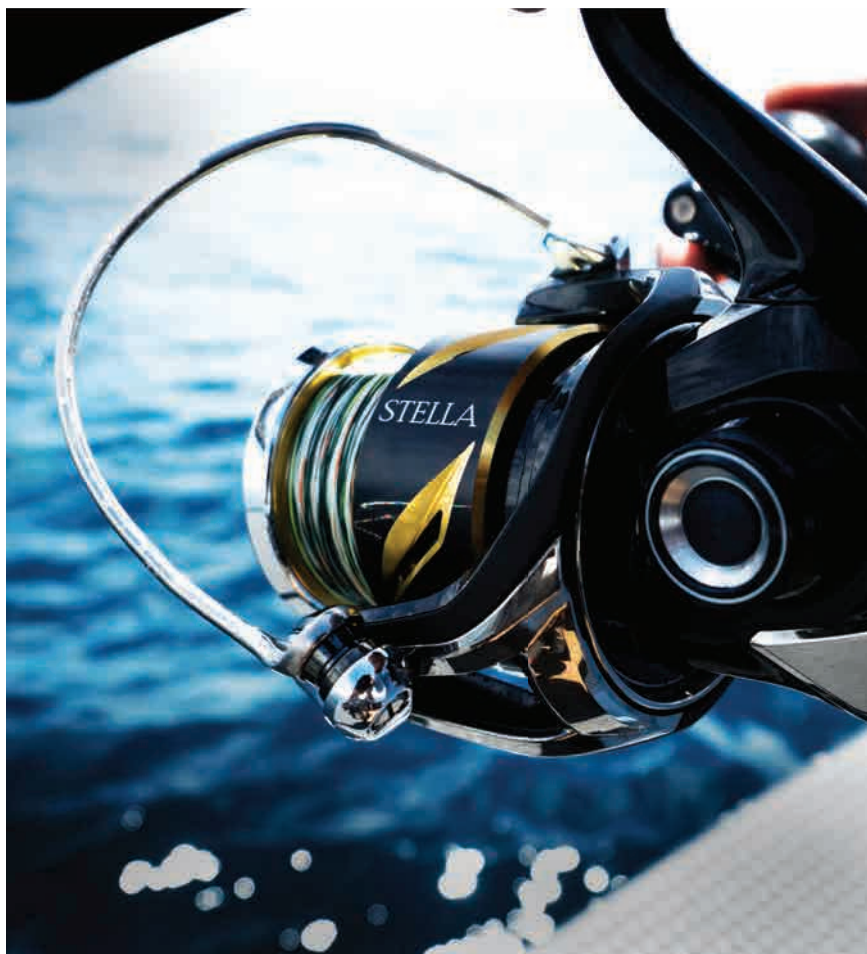

SALTWATER REEL TECHNOLOGY



LIGHT AND POWERFUL WINDING

INFINITYDRIVE

INFINITYDRIVE uses a special low-friction bush to greatly reduce sliding resistance of the main shaft. This achieves a reduction in rotational resistance for easier, smoother winding.

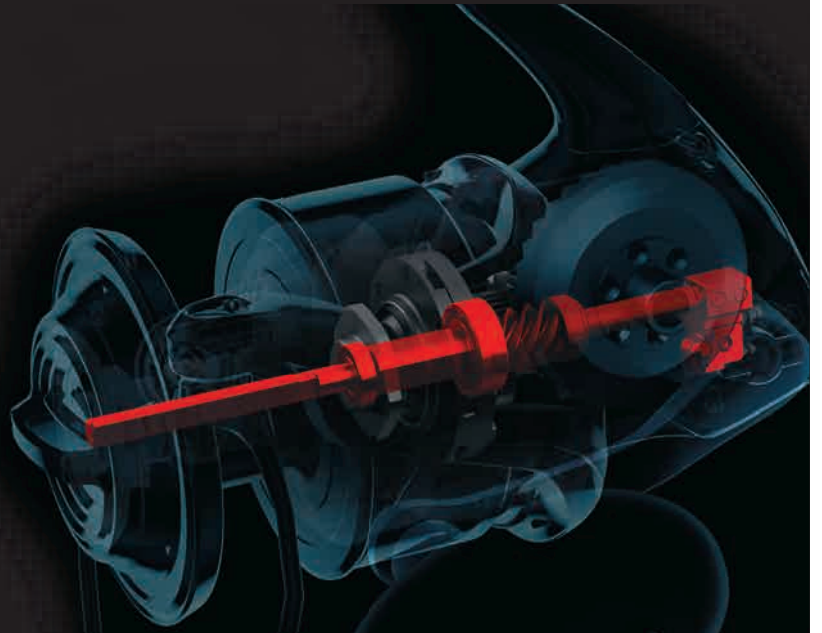
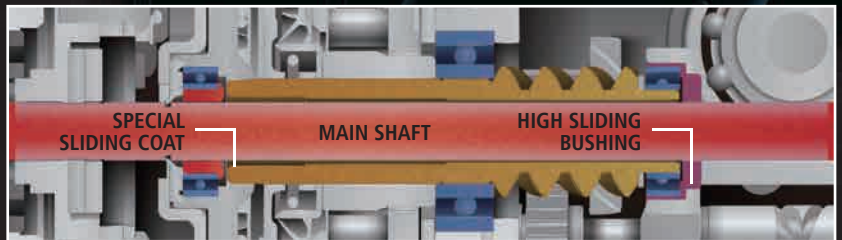

HEATSINK DRAG technology dissipates heat build-up in the spool by up to 50% when playing a hard running fish. By reducing heat build-up in the spool and the drag washers, drag performance is maintained at an efficient level.

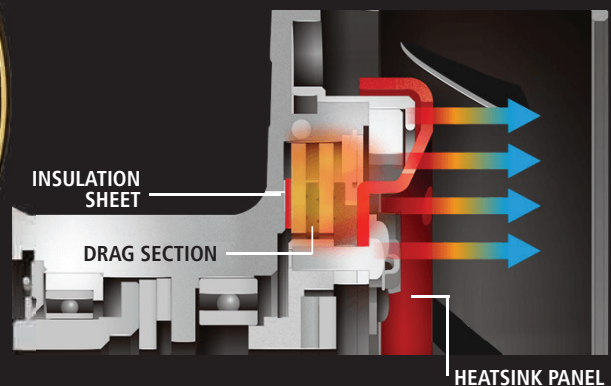

DOUBLE WATER RESISTANT PROTECTION FOR EXTREME SALTWATER CONDITIONS

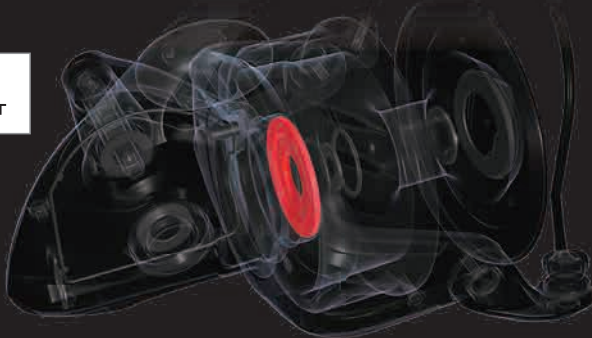
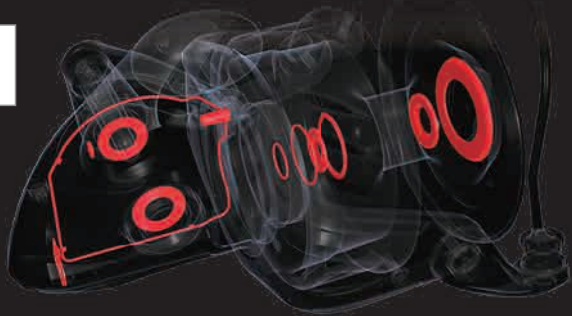

Saltwater intrusion into the inside of a reel can cause serious performance problems. Therefore it is imperative to enhance water resistance without impairing the properties of spinning reels designed for saltwater fishing.

These double water resistant structures - **X-SHIELD** for body protection and **X-PROTECT** for rotor protection satisfy such requirements by resisting saltwater ingress into the working parts of the reel.

POWERFUL FISH-PLAYING CONTROL



Designed to enhance smooth line release under extreme pressure, each drag washer is made of metal and carbon that is resistant to wear. The spool is supported from both directions to achieve drag performance with excellent durability and stability

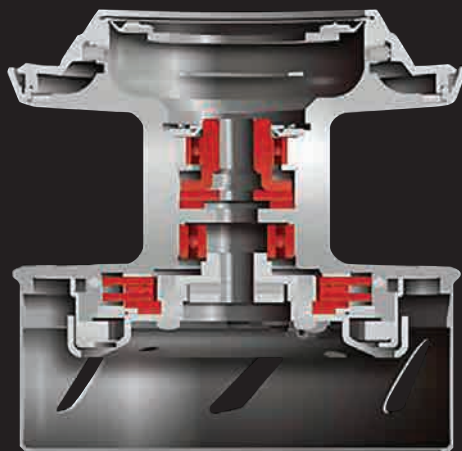

Supporting the spool with the main shaft and two bearing links in the spool reduces spool flutter to provide stable and smooth drag performance, especially in the initial stage of the fight.

MAXIMUM DRAG FORCE (KG)

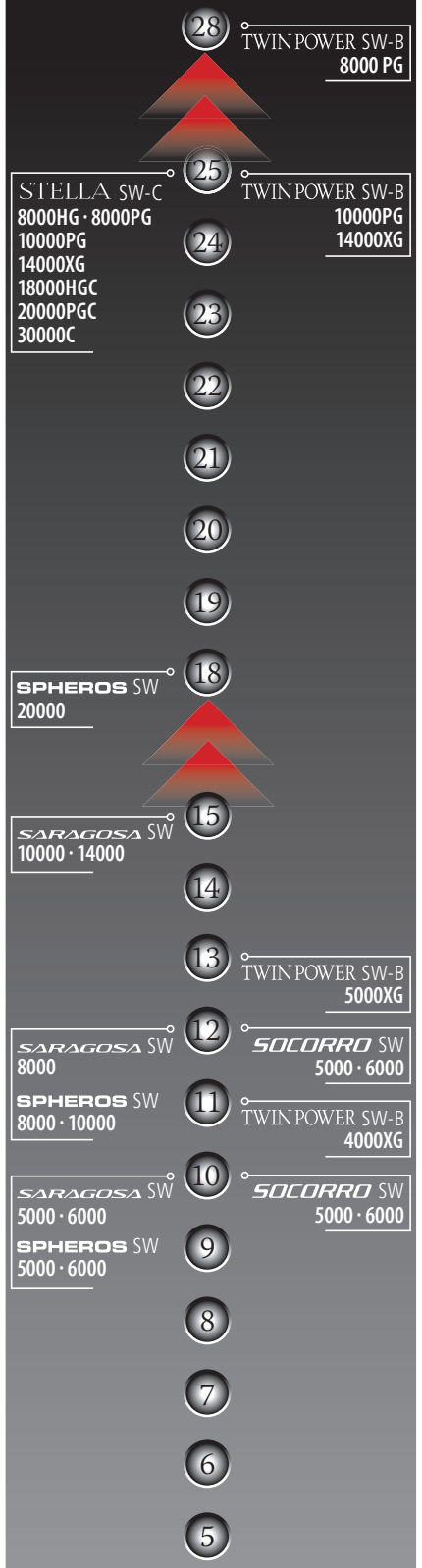

INFINITE POWER

STELLA SW

- The ultimate saltwater spinning reel with a worldwide reputation for excellence beyond comparison
- HAGANE Gear and Body for maximum strength and durability
- New InfinityDrive increases winding torque by up to 26% providing increased smoothness and light rotation whilst also increasing power
- Improved X-Protect and X-Shield for ultimate saltwater protection
- SilentDrive, re-engineered components reduce microscopic movement in the handle resulting in quieter operation
- X-Tough Drag is an upgraded drag providing more power and adjustment control
- Heat Sink spool technology (10000 + models only) controls heat created by the drag under extreme speed to help maintain original drag setting and also reduces line damage due to excessive heat
- 8000 size has new offset handle for more power and narrow rotor for 23% reduction in rotational inertia
- Aero Wrap and AR-C spool for maximum casting performance

SIZES: 4000, 5000, 6000, 8000, 10000, 14000, 18000, 20000, 30000

BEARINGS: 13 + 1

OSCILLATION: Aero Wrap

HANDLE: Screw in Aluminium with Ci4+ Round Knob
(10000, 14000 with Septon Oval-Round Knob)

WATER RESISTANT DRAG: Yes (X-Shield)



	9	10	11	12	13	14
STLSW4000HGC	355	5.7:1	0.30mm-180m	93	11	-
STLSW4000XGC	355	6.2:1	0.30mm-180m	101	11	-
STLSW5000HGC	420	5.7:1	0.33mm-200m	97	13	-
STLSW5000XGC	420	6.2:1	0.33mm-200m	105	13	-
STLSW6000PGC	425	4.7:1	0.33mm-240m	83	13	-
STLSW6000HGC	425	5.7:1	0.33mm-240m	103	13	-
STLSW6000XGC	425	6.2:1	0.33mm-240m	112	13	-
STLSW8000HGC	625	5.6:1	0.37mm-275m	107	25	-
STLSW8000PGC	625	4.9:1	0.37mm-275m	94	25	-
STLSW10000PGC	670	4.9:1	0.40mm-300m	102	25	-
STLSW14000XGC	675	6.2:1	0.40mm-330m	134	25	-
STLSW18000HGC	875	5.7:1	0.52mm-310m	129	25	-
STLSW20000PGC	885	4.4:1	0.52mm-350m	104	25	-
STLSW30000C	975	4.4:1	0.62mm-400m	131	25	-



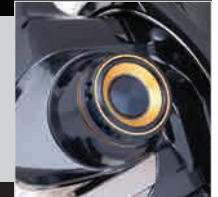

REEL TECHNOLOGY

FRONT DRAG REELS

REAR DRAG REELS

BIG PIT REELS

BAITRUNNER REELS

BAITCASTING REELS

SALTWATER REELS

MULTIPLIERS

EXTREME PERFORMANCE

TWIN POWER SW

- HAGANE Body and Gear for extreme performance
- X-SHIP gearing for maximum winding power and efficiency
- Heavy duty cold forged spool with AR-C design for extreme casting
- X-Shield water resistant drag with X-Tough carbon washers
- X-Shield aluminium body
- X-Protect aluminium rotor
- Aero Wrap oscillation for excellent line lay of mono or braid
- XG models have high speed 6.2:1 retrieve
- PG models have slower 4.9:1 retrieve

SIZES: 4000, 5000, 8000, 10000, 14000

BEARINGS: 11 + 1 (4000/5000), 10 + 1 (8000-14000)

OSCILLATION: Aero Wrap

HANDLE: Screw in Single Machined Aluminium

WATER RESISTANT DRAG: Yes (X-Shield)



	g	Ratio	Line	Retrieves	Parts	Model
TP4000SWBXG	355	6.2:1	0.31mm-170m	95	11	RD17071
TP5000SWBXG	420	6.2:1	0.33mm-200m	105	13	RD17019
TP8000SWBPG	635	4.9:1	0.37mm-275m	94	28	RD16961
TP10000SWBPG	650	4.9:1	0.40mm-300m	102	25	RD17005
TP14000SWBXG	650	6.2:1	0.40mm-330m	134	25	RD17008

Round handle knob: EVA (4000) and C14+ (5000, 8000)

Egg shaped rubber handle knob on sizes 10000 and 14000



TAKES SOME BEATING

NEW

SARAGOSA SW

- Mid priced high performance saltwater spinning and jigging reel
- HAGANE Body, HAGANE Gear and X-SHIP, combined with InfinityDrive for extreme cranking performance
- X-Protect (IPX-8 rating) for water protection and long-life durability
- Heavy duty cold forged spool with AR-C technology
- Compact models (5000 - 6000) for shore and lighter boat casting and jigging
- Mid-sized models (8000 - 14000) for shore and medium/heavy boat casting and jigging

SIZES: 5000, 6000, 8000, 10000, 14000

BEARINGS: 5+1

OSCILLATION: Varispeed II

HANDLE: Screw in Single Aluminium



	g	Ratio	Line	Ret	Sp	RD
SRG5000SWAXG	450	6.2:1	0.33mm-200m	105	10	RD21046
SRG6000SWAHG	455	5.7:1	0.33mm-240m	103	10	RD21091
SRG8000SWAHG	675	5.6:1	0.37mm-275m	107	12	RD21287
SRG10000SWAPG	685	4.9:1	0.40mm-300m	94	15	RD21320
SRG14000SWAXG	710	6.2:1	0.40mm-330m	135	15	RD21325
SRG18000SWAHG	915	5.7:1	0.52mm-310m	129	22	RD21389
SRG20000SWAPG	945	4.4:1	0.62mm-240m	104	20	RD21330
SRG25000SWA	970	4.4:1	0.52mm-400m	103	20	RD21387





SPHEROS SW

- HAGANE Body and XGT-7 (X-Protect) rotor
- X-SHIP gearing for maximum winding power and efficiency
- Varispeed II line lay and AR-C spool for improved casting
- Powerful water resistant drag – 18kg on 20000 size
- Super Stopper II delivers infinite anti-reverse that is always engaged for safety

BEARINGS: 4 + 1 | **OSCILLATION:** Varispeed II

	g	Ratio	Line	Retr.	Drag	RD
SP5000SW	455	4.6:1	0.37mm-150m	78	10	RD16570
SP6000SW	460	4.6:1	0.37mm-190m	83	10	RD16585
SP8000SW	700	4.9:1	0.40mm-230m	94	12	RD16552
SP10000SW	715	4.9:1	0.40mm-300m	102	15	RD16567
SP20000SW	930	4.4:1	0.52mm-350m	104	20	RD16536



NEW

SPHEROS SW

- HAGANE Body, HAGANE Gear and X-SHIP for maximum power and strength
- Small compact size for lighter weight rod and reel set-ups whilst retaining immense power
- Hi-speed retrieve for efficient fishing of spinning techniques
- Coreprotect water resistance for protection and light rotation feel
- Aero Wrap line lay and AR-C spool for improved casting

BEARINGS: 3 + 1 | **OSCILLATION:** Aero Wrap

	g	Ratio	Line	Retr.	Drag	RD
SPC3000HGSW	245	6.0:1	0.25mm-210m	88	9	-
SP3000XGSW	255	6.2:1	0.25mm-210m	91	9	-
SP4000XGSW	280	6.2:1	0.30mm-180m	99	11	-



SOCORRO SW

- Mid-sized saltwater reel offering great value for money
- HAGANE Gear and X-SHIP for maximum winding power and efficiency
- Water resistant Cross Carbon Drag for assured performance
- Cold forged AR-C spool for long range accurate casting

BEARINGS: 4 + 1 | **OSCILLATION:** Varispeed II

	g	Ratio	Line	Retr.	Drag	RD
SOC5000SW	440	4.6:1	0,37mm/150m	78	10	RD17411
SOC6000SW	445	4.6:1	0,37mm/190m	83	10	RD17430
SOC8000SW	640	4.9:1	0,40mm/230m	94	12	RD17433
SOC10000SW	665	4.9:1	0,40mm/300m	102	12	RD17454



MULTIPLIER REELS

SHIMANO multiplier reels have a reputation throughout the World for innovation and reliability and are trusted by anglers of all types, from Big Game professional anglers fishing for huge marlin, tuna and sharks to freshwater predator anglers fishing for large pike and catfish. Built without compromise, SHIMANO multipliers are available in both lever drag and star drag options.

LEVER DRAG

- 82 TIAGRA
- 83 TALICA · TALICA II
TYRNOS · TYRNOS II · TLD
- 84 SPEEDMASTER LD II
- 85 TR CHARTER SPECIAL · TR200

STAR DRAG

- 86 OCEA JIGGER F CUSTOM
- 87 OCEA JIGGER
- 88 OCEA CALCUTTA
- 89 TORIUM · TEKOTA

ELECTRIC

- 91 BEASTMASTER 9000
- 92 FORCEMASTER
- 93 PLAYS 4000 · PLAYS 600



MARKET LEADER

TIAGRA

- Worldwide market leader in Big Game Reels
- HAGANE Body for ultimate strength
- Cold Forged Aluminium spool
- 2-Speed gearing
- Twin disk drag system (Hydrothermal Drag on 50WLR & 80W versions)

SIZES: 30, 50, 80, 130

BEARINGS: 4

HANDLE: Single Steel Power Handle

WATERPROOF DRAG: Yes



TI30A	1486	3.9:1/1:1.7	50lb-385m	104/46	15		TT0694
TI30WLRSA	1576	3.9:1/1:1.7	50lb-520m	104/46	15		TT0699
TI50WLRSA	2447	3.1:1/1:1.3	80lb-500m	94/38	20		TT0725
TI80WA	3266	2.5:1/1:1.3	80lb-870m	94/48	24		TT0733
TI130A	4936	2.1:1/1:1.1	130lb-914m	99/56	40		TT0751



NEW MODELS



TALICA / TALICA II

- HAGANE Body for ultimate strength
- E.I. anti-corrosion surface treatment for saltwater resistance
- 2 speed and Single speed versions available
- New to the range, two CAM models with the addition of replaceable drag cams to allow top-level performance with braided or mono line

BEARINGS: 6 | **HANDLE:** Single Steel Power Handle

TAC12	655	5.7:1	25lb-255m	104	18	TGT1586
TAC16	669	5.7:1	30lb-275m	104	18	TGT1602
TAC16II	750	5.7:1/3,1:1	30lb-275m	104/56	20	TGT1602
TAC20IICAM	920	5.2:1/3,1:1	40lb/290m	104/56	20	- NEW
TAC25IICAM	950	5.2:1/3,1:1	50lb-235m	104/56	20	TGT1727 NEW
TAC50IIGR	1588	3.8:1/1.7:1	50lb-640m	114/53	27	TGT1958



TYRNOS TYRNOS II

- A powerful lever drag multiplier
- Larger sized reels designed for very large fish in deep water. Smaller models suited to Cod, Ling and Pollack but with extra strength if needed
- Aluminium frame keeps moving parts in precise alignment for increased efficiency and durability
- Features include Aluminium power handle, Duraluminium Spool, Stainless Steel Gears, Waterproof Drag and a Clicker System

BEARINGS: 4 | **HANDLE:** Single Aluminium Power Handle

TYR16	819	5.0:1	25lb-385m	115	15	TGT1164
TYR20	1021	5.0:1	30lb-410m	115	15	TGT0824
TYR30	1080	5.0:1	40lb-410m	115	15	TGT0847
TYR20II	1110	5.0:1/2.0:1	30lb-410m	115/46	15	TGT0824
TYR30II	1160	5.0:1/2.0:1	40lb-410m	115/46	15	TGT0847
TYR50IIILRS	1625	4.0:1/1.5:1	50lb-640m	111/41	19	TGT1427



TLD TLD II

- An iconic SHIMANO reel used all around the world in fresh and saltwater
- Widely regarded as being the industry standard in terms of affordable, high performance lever drag multiplier reels
- Lever drag allows for easy adjustment
- Suited to both monofilament and braid
- Ideal for targeting a wide variety of species with natural baits or artificial lures
- TLD 2 Speed reel can be switched from 4.0:1 ratio to 1.7:1 ratio with the push of a button

BEARINGS: 4 | **HANDLE:** Single Power Handle (TLD - Alu / TLD II SP Steel)

TLD15	527	4.0:1	20lb-410m	76	10	TLD0201
TLD20	670	3.6:1	30lb-410m	81	10	TLD0174
TLD25	695	3.6:1	30lb-550m	81	10	TLD0177
TLD30IIA	1064	4.0:1/1.7:1	30lb-550m	94/41	15	TT0790
TLD50IIA	1624	3.5:1/1.4:1	50lb-640m	97/38	17	TT0381

EASY HANDLING

NEW MODELS

SpeedMaster LD II

- Durable and castable 2-speed lever drag reel designed for stand up fishing
- Aluminium HAGANE Body in S Compact Body design for strength and easy handling
- Loud clicker system making it perfect for live bait fishing
- 2-Speed operation for versatility
- Accessory Drag cam lever available to make drag adjustment

SIZES: 12, 16, 20, 25
BEARINGS: 4
HANDLE: Single Aluminium Egg Shape
WATERPROOF DRAG: Yes



SPM12II	730	5.7:1/3.1:1	20lb-320m	107/58	18	-	
SPM16II	750	5.7:1/3.1:1	20lb-400m	107/58	18	-	
SPM20II	980	5.2:1/2.3:1	30lb-430m	131/58	20	-	NEW
SPM25II	1025	5.2:1/2.3:1	40lb-385m	131/58	20	-	NEW

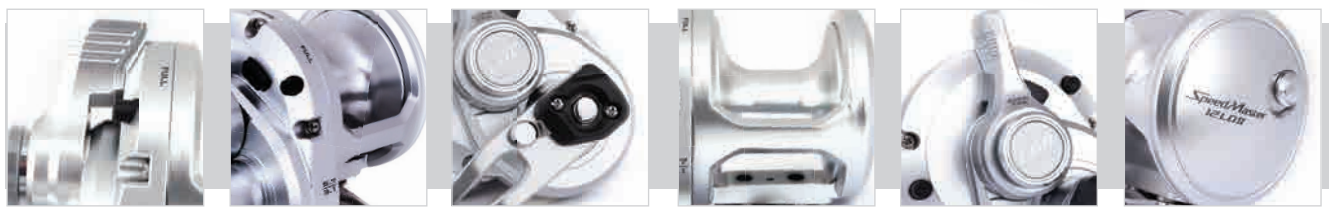



Charter Special

- Quite possibly the most versatile, affordable multiplier reels available and a firm favourite with professional charter skippers
- Unique combination of a smooth lever drag, level wind and a centrifugal braking system
- Rigid, corrosion free graphite frame proves extremely robust
- Suited to both monofilament and braid
- Completed with a Stainless Steel gear, waterproof drag and clicker system

SIZES: 1000, 2000

BEARINGS: 4

HANDLE: Single Aluminium Power Handle

WATERPROOF DRAG: Yes



TR

- The perfect star drag multiplier reel for the novice angler
- Level wind ensures perfect distribution of line across the spool
- Clicker System to indicate bites when set on freespool
- Single steel power handle provides immense winding power
- Stainless Steel gear for high strength and durability

SIZES: 200

BEARINGS: 1

HANDLE: Single Steel Power Handle



Model	Weight (g)	Gear Ratio	Line Capacity (lb)	Line Length (m)	Spool Diameter (mm)	Spool Turns	Part Number
TR1000LD	465	5.2:1	14lb	300m	66	15	TGT0110
TR2000LD	485	5.2:1	14lb	440m	66	15	TGT0118

Model	Weight (g)	Gear Ratio	Line Capacity (lb)	Line Length (m)	Spool Diameter (mm)	Spool Turns	Part Number
TR200G	374	4.3:1	17lb	365m	64	6	TGT0075

TOTAL CONTROL

NEW

OCEA JIGGER F CUSTOM

- Featuring a 'FALL' lever to control the speed of a falling jig with greater precision from total free-fall to ultra-slow
- HAGANE Body for maximum strength under pressure
- Micromodule gear with 8 Shielded A-RB bearings plus roller bearing
- Waterproof carbon drag with SHIMANO Exciting Drag Sound
- X-Protect prevents water intrusion without increasing winding resistance
- Salt resistant EI protection

SIZES: 1500, 2000

BEARINGS: 8 + 1

HANDLE: Single Power Handle



	g	W	H	L	Ret	Sp
OCEAJGFC1500HG	430	6.4:1	0.33mm-210m	98	7	-
OCEAJGFC1501HG	430	6.4:1	0.33mm-210m	98	7	-
OCEAJGFC2000NR	605	6.2:1	0.33mm-300m	117	10	-
OCEAJGFC2001NR	605	6.2:1	0.33mm-300m	117	10	-



NARROW SPOOL

OCEA JIGGER

- Designed with narrow, deep spool especially for deep water jigging
- HAGANE Body for maximum strength under pressure
- Micromodule gear with 8 Shielded A-RB bearings plus roller bearing
- Waterproof carbon drag with SHIMANO Exciting Drag Sound
- X-Protect prevents water intrusion without increasing winding resistance
- Salt resistant EI protection
- Handle length can be adjusted from 73mm to 85mm for additional cranking power
- High Gear model retrieves 117cm of line per handle turn, Power model retrieves 96cm of line

SIZES: 2000

BEARINGS: 8 + 1

HANDLE: Single Power Handle



5RL02211H	595	6.2:1	0.33mm-300m	117	10	03672-0074
5RL02211P	595	5.1:1	0.33mm-300m	96	10	03674-0074



LIGHT SEA JIGGING

OCEA CALCUTTA

- Designed for light salt water jigging
- HAGANE Body for maximum strength under pressure
- X-SHIP gearing with 5 Shielded A-RB bearings plus roller bearing
- Super Free spool has waterproof carbon drag with SHIMANO Exciting Drag Sound
- Salt resistant E.I. protection
- Clicker System and Level Wind for excellent line control
- Retrieves 81cm of line per handle turn

SIZES: 301

BEARINGS: 5 + 1

HANDLE: Single Power Handle



5RH710301

350 6.0:1 0.28mm-200m 81 6 03059-0085





TORIUM

- S Compact aluminum body for easy handling and tough conditions
- Brass gears with high speed 6.2:1 retrieve - 117cm of line per handle turn
- Cross carbon drag washers for smooth operation up to 11kg maximum drag
- Cold forged aluminium spool
- Micro adjustable drag system

SIZES: 14, 16, 20

BEARINGS: 3 + 1

HANDLE: Single Cold Forged Aluminium Handle



	g	Ratio	Line	Ret	Spool	Drag
TOR14HGA	425	6.3:1	14lb-275m	97	15	TGT2238
TOR16HGA	535	6.2:1	16lb-410m	117	11	TGT2084
TOR20HGA	545	6.2:1	20lb-385m	117	11	TGT2093
LEFT-HAND MODELS						
TOR16HGAL	535	6.2:1	16lb-410m	117	11	TGT2084
TOR20HGAL	545	6.2:1	20lb-385m	117	11	TGT2093

NEW MODELS

TEKOTA

- S Compact HAGANE Body (except 700 model) for extreme strength
- Geared with a fast ratio of 6.3:1
- Level wind added to ensure excellent line lay
- Easily adjustable and reliable Star Drag
- Available with a line counter option for targeting fish feeding at specific depths
- Brass gear for high strength and durability

SIZES: 301, 401, 500, 501, 600, 601, 700

BEARINGS: 3 + 1

HANDLE: Single Cold Forged Aluminium Handle



	g	Ratio	Line	Ret	Spool	Drag	
TEK301LCA	340	6.6:1	12lb-215m	89	9	-	NEW
TEK401HGLCA	370	6.6:1	12lb-300m	89	9	-	NEW
TEK501HGLCA	430	6.3:1	12lb-400m	75	11	-	
TEK500HGLCMA	430	6.3:1	12lb-400m	75	11	TGT2304	
TEK601HGLCA	450	6.3:1	20lb-275m	75	11	-	
TEK600HGLCMA	450	6.3:1	20lb-275m	75	11	TGT2334	
TEK700LCM	845	4.2:1	25lb-375m	84	11	TGT1462	

ELECTRIC PERFORMANCE

A BRUSHLESS DC MOTOR FOUND IN THE BEASTMASTER...



AMAZING PERFORMANCE, EVEN A RISE IN TEMPERATURE CANNOT SLOW IT DOWN!

Inside the motor, there is a special strong magnet that can maintain its performance level even at high temperatures. The motor is specially tuned to meet the reel's specific performance target.



THERMO ADJUST DRAG

A control function to suppress abnormal heat generation in the drag section to maintain stable drag performance. There are instances when the drag slips immediately after the motor is turned on and this gives off additional heat. When the drag slips, rotation speed of the motor is automatically lowered to prevent this additional heat from being generated.



E-EXCITING DRAG SOUND

Digitalising the exciting drag sound, this feature instills excitement in the angler when fighting fish.



FINE DOT LCD

A liquid crystal LCD screen with high visibility and hence, operability.

AMAZING POWER

BeastMaster

- Fitted with advanced, brushless motor for high speed, high torque operation
- Thermo adjust drag control suppresses heat generation and has double heat dissipation
- Maintainable winding strength is 20kg
- Maximum winding speed is 165m/min
- Exciting drag sound - when the drag is activated an electronic sound is heard, the larger the fish, the greater the sound
- LCD display screen provides all required information

SIZES: 9000

BEARINGS: 14

HANDLE: Single Aluminium Power Handle



BM9000A

1485 3.1:1 PE8-900m 88 25 -

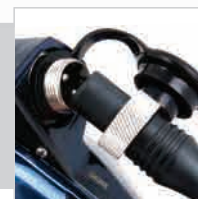
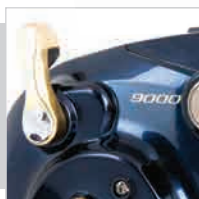

ADVANCED FEATURES

NEW

ForceMaster 9000

- HAGANE Body with Heat Free System II ventilation ports for efficient heat dissipation of motor heat
- Advanced, brushless motor for high speed, high torque operation
- Multi-disc drag with four carbon cross washers generating 25kg maximum drag pressure
- Maintainable winding strength is 14kg
- Maximum winding speed is 140m/min
- Exciting drag sound - when the drag is activated an electronic sound is heard, the larger the fish, the greater the sound
- Constant tension and constant speed retrieve modes
- Fine dot LCD display screen provides all required information

SIZE: 9000

BEARINGS: 3

HANDLE: Single Aluminium Power Handle



FM9000A

--	--	--	--	--	--





PLAYS

- Updated electric reel with sporty and modern look
- Technical features: HAGANE body, carbon drag, heat free system
- Several reeling modes including jigging mode
- Drag force of 15kg
- Maintainable winding strength is 10kg
- Maximum winding speed is 170m/min

SIZES: 4000

BEARINGS: 2

HANDLE: Single Aluminium Power Handle



PLAYS4000

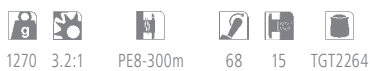

NEW

PLAYS

- Versatile mid-sized electric reel
- Ultra high quality S AR-B Bearings
- Cross Carbon Drag with Heat Free System
- Maintainable winding strength is 3kg
- Maximum winding speed is 155m/min
- LCD display screen

SIZES: 600

BEARINGS: 5

HANDLE: Single Aluminium Power Handle



PLAYS600



MODEL	HAGANE GEAR	DRIVE GEAR	X-SHIP	HAGANE BODY	BODY MATERIAL	MGL ROTOR	X-PROTECT	SILENTDRIVE	G-FREE BODY	AR-C SPOOL	ONE-PIECE BAIL	WEIGHT (G)	BB QTY	LINE RETRIEVE PER CRANK (CM)	GEAR RATIO	MAX DRAG FORCE (KG)	WATER PROOF DRAG	
FRONT DRAG																		
STELLA 1000 FJ	✓	✓	✓	✓	MAGNESIUM		✓	✓	✓	✓	✓	170	12	64	5.1:1	3	✓	
STELLA 2500 FJ	✓	✓	✓	✓	MAGNESIUM		✓	✓	✓	✓	✓	205	12	78	5.3:1	9	✓	
STELLA 2500 HG FJ	✓	✓	✓	✓	MAGNESIUM		✓	✓	✓	✓	✓	205	12	89	6.0:1	9	✓	
STELLA 2500S HG FJ	✓	✓	✓	✓	MAGNESIUM		✓	✓	✓	✓	✓	205	12	78	6.1:1	4	✓	
STELLA C3000M HG FJ	✓	✓	✓	✓	MAGNESIUM		✓	✓	✓	✓	✓	210	12	89	6.0:1	9	✓	
STELLA C3000 FJ	✓	✓	✓	✓	MAGNESIUM		✓	✓	✓	✓	✓	210	12	89	5.3:1	9	✓	
STELLA C3000 XG FJ	✓	✓	✓	✓	MAGNESIUM		✓	✓	✓	✓	✓	210	12	94	6.4:1	9	✓	
STELLA 4000 FJ	✓	✓	✓	✓	MAGNESIUM		✓	✓	✓	✓	✓	255	12	87	5.3:1	11	✓	
STELLA 4000 XG FJ	✓	✓	✓	✓	MAGNESIUM		✓	✓	✓	✓	✓	255	12	101	6.2:1	11	✓	
STELLA C5000 XG FJ	✓	✓	✓	✓	MAGNESIUM		✓	✓	✓	✓	✓	260	12	101	6.2:1	11	✓	
TWINPOWER FD 1000	✓	✓	✓	✓	ALUMINUM		✓	✓	✓	✓	✓	175	9	64	5.1:1	3	✓	
TWINPOWER FD C2000S	✓	✓	✓	✓	ALUMINUM		✓	✓	✓	✓	✓	180	9	69	5.1:1	3	✓	
TWINPOWER FD 2500	✓	✓	✓	✓	ALUMINUM		✓	✓	✓	✓	✓	210	9	78	5.3:1	9	✓	
TWINPOWER FD 2500SHG	✓	✓	✓	✓	ALUMINUM		✓	✓	✓	✓	✓	210	9	89	6.0:1	4	✓	
TWINPOWER FD C3000	✓	✓	✓	✓	ALUMINUM		✓	✓	✓	✓	✓	215	9	78	5.3:1	9	✓	
TWINPOWER FD C3000XG	✓	✓	✓	✓	ALUMINUM		✓	✓	✓	✓	✓	215	9	94	6.4:1	9	✓	
TWINPOWER FD 4000	✓	✓	✓	✓	ALUMINUM		✓	✓	✓	✓	✓	255	9	87	5.3:1	11	✓	
TWINPOWER FD 4000PG	✓	✓	✓	✓	ALUMINUM		✓	✓	✓	✓	✓	260	9	72	4.4:1	11	✓	
TWINPOWER FD 4000XG	✓	✓	✓	✓	ALUMINUM		✓	✓	✓	✓	✓	260	9	101	6.2:1	11	✓	
TWINPOWER FD 4000MHG	✓	✓	✓	✓	ALUMINUM		✓	✓	✓	✓	✓	255	9	95	5.8:1	11	✓	
TWINPOWER FD 1000	✓	✓	✓	✓	ALUMINUM		✓	✓	✓	✓	✓	260	9	101	6.2:1	11	✓	
STRADIC 1000 FL	✓	✓	✓	✓	ALUMINUM		✓	✓	✓	✓	✓	185	6	64	5.1:1	3	✓	
STRADIC 1000 HG FL	✓	✓	✓	✓	ALUMINUM		✓	✓	✓	✓	✓	185	6	75	6.0:1	3	✓	
STRADIC 2500 FL	✓	✓	✓	✓	ALUMINUM		✓	✓	✓	✓	✓	220	6	78	5.3:1	9	✓	
STRADIC 2500 HG FL	✓	✓	✓	✓	ALUMINUM		✓	✓	✓	✓	✓	225	6	89	6.0:1	9	✓	
STRADIC C3000 FL	✓	✓	✓	✓	ALUMINUM		✓	✓	✓	✓	✓	225	6	78	5.3:1	9	✓	
STRADIC C3000 HG FL	✓	✓	✓	✓	ALUMINUM		✓	✓	✓	✓	✓	225	6	89	6.0:1	9	✓	
STRADIC C3000 XG FL	✓	✓	✓	✓	ALUMINUM		✓	✓	✓	✓	✓	225	6	94	6.4:1	9	✓	
STRADIC 4000 FL	✓	✓	✓	✓	ALUMINUM		✓	✓	✓	✓	✓	280	6	87	5.3:1	11	✓	
STRADIC 4000 MHG FL	✓	✓	✓	✓	ALUMINUM		✓	✓	✓	✓	✓	280	6	95	5.8:1	11	✓	
STRADIC 4000 XG FL	✓	✓	✓	✓	ALUMINUM		✓	✓	✓	✓	✓	280	6	101	6.2:1	11	✓	
STRADIC C5000 XG FL	✓	✓	✓	✓	ALUMINUM		✓	✓	✓	✓	✓	295	6	101	6.2:1	11	✓	
SOARRE BB 2000		CF ALU	✓		XT-7				✓	✓	✓	200	5	57	4.3:1	3	✓	
SEPHIA BB 3000		CF ALU	✓		XT-7				✓	✓	✓	235	5	73	5.0:1	9	✓	
ULTEGRA 1000 FB		CF ALU	✓		XT-7				✓	✓	✓	200	5	66	5.0:1	3	✓	
ULTEGRA 2500 FB		CF ALU	✓		XT-7				✓	✓	✓	240	5	88	5.0:1	9	✓	
ULTEGRA 2500HG FB		CF ALU	✓		XT-7				✓	✓	✓	240	5	73	6.0:1	9	✓	
ULTEGRA C3000 FB		CF ALU	✓		XT-7				✓	✓	✓	240	5	88	5.0:1	9	✓	
ULTEGRA C3000HG FB		CF ALU	✓		XT-7				✓	✓	✓	285	5	77	6.0:1	9	✓	
ULTEGRA 4000 FB		CF ALU	✓		XT-7				✓	✓	✓	285	5	99	4.8:1	11	✓	
ULTEGRA 4000XG FB		CF ALU	✓		XT-7				✓	✓	✓	285	5	105	6.2:1	11	✓	
ULTEGRA C5000XG FB		CF ALU	✓		XT-7				✓	✓	✓	285	5	105	6.2:1	11	✓	
EXSENCE C3000M HG	✓	✓	✓	✓	MAGNESIUM	✓	✓		✓	✓	✓	220	11	88	6.0:1	9	✓	
EXSENCE 4000M XG	✓	✓	✓	✓	MAGNESIUM	✓	✓		✓	✓	✓	245	11	99	6.2:1	11	✓	
VANQUISH C2000S FB	✓	✓	✓	✓	MAGNESIUM	✓	✓	✓	✓	✓	✓	145	11	69	5.1:1	3	✓	
VANQUISH C2500S HG FB	✓	✓	✓	✓	MAGNESIUM	✓	✓	✓	✓	✓	✓	155	11	81	6.0:1	3	✓	
VANQUISH 2500S FB	✓	✓	✓	✓	MAGNESIUM	✓	✓	✓	✓	✓	✓	165	11	78	5.3:1	4	✓	
VANQUISH 2500SHG FB	✓	✓	✓	✓	MAGNESIUM	✓	✓	✓	✓	✓	✓	165	11	89	6.0:1	4	✓	
VANQUISH C3000 FB	✓	✓	✓	✓	MAGNESIUM	✓	✓	✓	✓	✓	✓	170	11	78	5.3:1	9	✓	
VANQUISH C3000M HG FB	✓	✓	✓	✓	MAGNESIUM	✓	✓	✓	✓	✓	✓	170	11	89	6.0:1	9	✓	
VANQUISH 4000M HG FB	✓	✓	✓	✓	MAGNESIUM	✓	✓	✓	✓	✓	✓	205	11	95	5.8:1	11	✓	
VANQUISH 4000 XG FB	✓	✓	✓	✓	MAGNESIUM	✓	✓	✓	✓	✓	✓	200	11	101	6.2:1	11	✓	
VANQUISH C5000 XG FB	✓	✓	✓	✓	MAGNESIUM	✓	✓	✓	✓	✓	✓	220	11	101	6.2:1	11	✓	
TWINPOWER XD C3000HG		CF ALU	✓	✓	ALUMINUM	✓	✓		✓	✓	✓	235	9	88	6.0:1	9	✓	
TWINPOWER XD C3000XG		CF ALU	✓	✓	ALUMINUM	✓	✓		✓	✓	✓	235	9	93	6.4:1	9	✓	
TWINPOWER XD 4000XG		CF ALU	✓	✓	ALUMINUM	✓	✓		✓	✓	✓	290	9	99	6.2:1	11	✓	
TWINPOWER XD C5000XG		CF ALU	✓	✓	ALUMINUM	✓	✓		✓	✓	✓	300	9	103	6.2:1	11	✓	
SUSTAIN 2500 FI		CF ALU	✓	✓	ALUMINUM	✓			✓	✓	✓	235	8	73	5.0:1	9	✓	
SUSTAIN C3000HG FI		CF ALU	✓	✓	ALUMINUM	✓			✓	✓	✓	225	8	88	6.0:1	9	✓	
SUSTAIN 4000 FI		CF ALU	✓	✓	ALUMINUM	✓			✓	✓	✓	280	8	77	4.8:1	11	✓	
SUSTAIN 4000XG FI		CF ALU	✓	✓	ALUMINUM	✓			✓	✓	✓	285	8	99	6.2:1	11	✓	
SUSTAIN C5000XG FI		CF ALU	✓	✓	ALUMINUM	✓			✓	✓	✓	285	8	103	6.2:1	11	✓	
CARDIFF CI4+ 1000S		CF ALU	✓	✓	C14+	✓			✓	✓	✓	170	9	66	5.0:1	3	✓	
CARDIFF CI4+ C3000M HG		CF ALU	✓	✓	C14+	✓	✓		✓	✓	✓	200	9	88	6.0:1	9	✓	
VANFORD 500		✓	✓	✓	C14+	✓	✓	✓	✓	✓	✓	140	6	69	5.6:1	2.5	✓	
VANFORD 1000		✓	✓	✓	C14+	✓	✓	✓	✓	✓	✓	150	7	64	5.1:1	3	✓	
VANFORD C2000S		✓	✓	✓	C14+	✓	✓	✓	✓	✓	✓	150	7	69	5.1:1	3	✓	
VANFORD C2000SHG		✓	✓	✓	C14+	✓	✓	✓	✓	✓	✓	150	7	82	6.1:1	3	✓	
VANFORD 2500		✓	✓	✓	C14+	✓	✓	✓	✓	✓	✓	180	7	78	5.3:1	9	✓	
VANFORD 2500S		✓	✓	✓	C14+	✓	✓	✓	✓	✓	✓	175	7	78	5.3:1	4	✓	
VANFORD 2500SHG		✓	✓	✓	C14+	✓	✓	✓	✓	✓	✓	175	7	89	6.0:1	4	✓	
VANFORD 2500HG		✓	✓	✓	C14+	✓	✓	✓	✓	✓	✓	180	7	89	6.0:1	9	✓	

REEL SPECIFICATIONS

MODEL	HAGANE GEAR	DRIVE GEAR	X-SHIP	HAGANE BODY	BODY MATERIAL	MGL ROTOR	X-PROTECT	SILENTDRIVE	G-FREE BODY	AR-C SPOOL	ONE-PIECE BAIL	WEIGHT (G)	BB QTY	LINE RETRIEVE PER CRANK(CM)	GEAR RATIO	MAX DRAG FORCE(KG)	WATER PROOF DRAG
VANFORD C3000					C14+	✓				✓	✓	180	7	78	5.3:1	9	✓
VANFORD C3000HG					C14+	✓				✓	✓	180	7	89	6.0:1	9	✓
VANFORD 4000					C14+	✓				✓	✓	215	7	87	5.3:1	11	✓
VANFORD 4000MHG					C14+	✓				✓	✓	215	7	95	5.8:1	11	✓
VANFORD 4000XG					C14+	✓				✓	✓	215	7	101	6.2:1	11	✓
VANFORD C5000XG					C14+	✓				✓	✓	220	7	101	6.2:1	11	✓
NASCI 500 FB		CF ALU			XT-7					✓		175	4	69	5.6:1	2.5	✓
NASCI 1000 FB		CF ALU			XT-7					✓		215	4	66	5.0:1	3	✓
NASCI C2000S FB		CF ALU			XT-7					✓		220	4	66	5.0:1	3	✓
NASCI C2000S FB HG		CF ALU			XT-7					✓		220	4	79	6.0:1	3	✓
NASCI 2500 FB		CF ALU			XT-7					✓		250	4	73	5.0:1	9	✓
NASCI 2500S FB HG		CF ALU			XT-7					✓		250	4	91	6.2:1	4	✓
NASCI C3000 FB		CF ALU			XT-7					✓		250	4	73	5.0:1	9	✓
NASCI C3000 FB HG		CF ALU			XT-7					✓		250	4	91	6.2:1	9	✓
NASCI 4000 FB		CF ALU			XT-7					✓		295	4	75	4.7:1	11	✓
NASCI 4000 FB XG		CF ALU			XT-7					✓		295	4	99	6.2:1	11	✓
NASCI C5000 FB XG		CF ALU			XT-7					✓		300	4	105	6.2:1	11	✓
SAHARA 500 FI		CF ALU			XT-7					✓		175	4	69	6.2:1	2.5	
SAHARA 1000 FI		CF ALU			XT-7					✓		215	4	66	5.0:1	3	
SAHARA C2000S FI		CF ALU			XT-7					✓		220	4	66	5.0:1	3	
SAHARA C2000HGS FI		CF ALU			XT-7					✓		220	4	79	6.0:1	3	
SAHARA 2500 FI		CF ALU			XT-7					✓		250	4	73	5.0:1	9	
SAHARA 2500HGS FI		CF ALU			XT-7					✓		250	4	91	6.2:1	4	
SAHARA C3000 FI		CF ALU			XT-7					✓		250	4	73	5.0:1	9	
SAHARA C3000HG FI		CF ALU			XT-7					✓		250	4	91	6.2:1	9	
SAHARA C3000DH FI		CF ALU			XT-7					✓		280	4	73	5.0:1	9	
SAHARA 4000 FI		CF ALU			XT-7					✓		295	4	75	4.7:1	11	
SAHARA 4000XG FI		CF ALU			XT-7					✓		295	4	99	6.2:1	11	
SAHARA C5000XG FI		CF ALU			XT-7					✓		300	4	105	6.2:1	11	
SEDONA 500FI		ZINC DIECAST			XT-7					✓		185	3	69	5.6:1	2.5	
SEDONA 1000 FI		CF ALU			XT-7					✓		215	3	66	5.0:1	3	
SEDONA C2000S FI		CF ALU			XT-7					✓		215	3	66	5.0:1	3	
SEDONA C2000S-HG FI		CF ALU			XT-7					✓		215	3	79	6.0:1	3	
SEDONA 2500 FI		CF ALU			XT-7					✓		245	3	73	5.0:1	4	
SEDONA 2500HG FI		CF ALU			XT-7					✓		245	3	91	6.2:1	4	
SEDONA 2500S FI		CF ALU			XT-7					✓		245	3	73	5.0:1	4	
SEDONA C3000 FI		CF ALU			XT-7					✓		250	3	73	5.0:1	9	
SEDONA C3000HG FI		CF ALU			XT-7					✓		250	3	91	6.2:1	9	
SEDONA C3000DH FI		CF ALU			XT-7					✓		275	3	73	5.0:1	9	
SEDONA 4000 FI		CF ALU			XT-7					✓		295	3	75	4.7:1	11	
SEDONA 4000XG FI		CF ALU			XT-7					✓		295	3	99	6.2:1	11	
SEDONA C5000XG FI		CF ALU			XT-7					✓		300	3	105	6.2:1	11	
SEDONA 6000 FI		CF ALU			XT-7					✓		425	3	83	4.6:1	10	
SEDONA 8000 FI		CF ALU			XT-7					✓		615	3	94	4.9:1	11	
NEXAVE 1000 FE		ZINC DIECAST			XT-7					✓		215	3	61	5.0:1	3	
NEXAVE 2500 FE		ZINC DIECAST			XT-7					✓		255	3	71	5.0:1	4	
NEXAVE 2500 HG FE		ZINC DIECAST			XT-7					✓		255	3	88	6.2:1	4	
NEXAVE C3000 FE		ZINC DIECAST			XT-7					✓		260	3	71	5.0:1	8.5	
NEXAVE C3000 HG FE		ZINC DIECAST			XT-7					✓		260	3	88	6.2:1	8.5	
NEXAVE 4000 FE		ZINC DIECAST			XT-7					✓		325	3	82	5.2:1	8.5	
NEXAVE 4000 HG FE		ZINC DIECAST			XT-7					✓		325	3	91	5.8:1	8.5	
NEXAVE C5000 FE HG		ZINC DIECAST			XT-7					✓		320	3	93	5.8:1	8.5	
NEXAVE 6000 FE		ZINC DIECAST			XT-7					✓		595	3	91	4.9:1	8	
NEXAVE 8000 FE		ZINC DIECAST			XT-7					✓		580	3	92	4.9:1	8	
CATANA 1000 FD		ZINC DIECAST			XT-7					✓		215	2	61	5.0:1	3	
CATANA 2500 FD		ZINC DIECAST			XT-7					✓		260	2	71	5.0:1	4	
CATANA 2500 HG FD		ZINC DIECAST			XT-7					✓		260	2	88	6.2:1	4	
CATANA C3000 FD		ZINC DIECAST			XT-7					✓		260	2	71	5.0:1	8.5	
CATANA C3000 HG FD		ZINC DIECAST			XT-7					✓		260	2	89	6.2:1	8.5	
CATANA 4000 FD		ZINC DIECAST			XT-7					✓		335	2	82	5.2:1	8.5	
CATANA 4000 HG FD		ZINC DIECAST			XT-7					✓		335	2	91	5.8:1	8.5	
SIENNA 500 FG		ZINC DIECAST			XT-7					✓		195	3	69	5.6:1	2	
SIENNA 1000 FG		ZINC DIECAST			XT-7					✓		225	3	66	5.0:1	3	
SIENNA 2000 FG		ZINC DIECAST			XT-7					✓		250	3	71	5.0:1	4	
SIENNA 2500 FG		ZINC DIECAST			XT-7					✓		250	3	71	5.0:1	4	
SIENNA 2500 HG FG		ZINC DIECAST			XT-7					✓		250	3	88	6.2:1	4	
SIENNA C3000 FG		ZINC DIECAST			XT-7					✓		250	3	71	5.0:1	8.5	
SIENNA 4000 FG		ZINC DIECAST			XT-7					✓		320	3	82	5.2:1	8.5	
FX 1000 FC		ZINC DIECAST			XT-7					✓		225	2	66	5.0:1	3	
FX 2000 FC		ZINC DIECAST			XT-7					✓		250	2	71	5.0:1	4	
FX 2500 FC		ZINC DIECAST			XT-7					✓		250	2	71	5.0:1	4	
FX 2500 HG FC		ZINC DIECAST			XT-7					✓		250	2	88	6.2:1	4	
FX C3000 FC		ZINC DIECAST			XT-7					✓		250	2	71	5.0:1	8.5	
FX 4000 FC		ZINC DIECAST			XT-7					✓		320	2	82	5.2:1	8.5	

REEL SPECIFICATIONS

FRONT DRAG REELS

REAR DRAG REELS

BIG PIT REELS

BAITRUNNER REELS

BAITCASTING REELS

SALTWATER REELS

MULTIPLIERS

MODEL	HAGANE GEAR	SPOOL MATERIAL /TYPE	AR-C SPOOL	BODY MATERIAL	OSCILLATION	ONE-PIECE BAIL	WEIGHT (G)	BB QTY	LINE RETRIEVE PER CRANK(CM)	GEAR RATIO	LINE CAPACITY	DRAG TYPE	MAX DRAG FORCE(KG)	DRAG TECHNOLOGY
REAR DRAG REELS														
STRADIC CI4+ 2500RA		COLD FORGED ALU	✓	CI4+		✓	255	5	98	6.0:1	0,20mm-240m	RD II	2.5	FIGHTIN' DRAG
STRADIC CI4+ 4000RA		COLD FORGED ALU	✓	CI4+		✓	310	5	93	5.2:1	0,25mm-260m	RD II	3	FIGHTIN' DRAG
STRADIC GTM-RC 2500		ZINC DIECAST	✓	XT-7			315	4	88	6.0:1	0,20mm-240m	RD II	2.5	FIGHTIN' DRAG
STRADIC GTM-RC 3000		ZINC DIECAST	✓	XT-7			345	4	92	6.0:1	0,25mm-140m	RD II	2.5	FIGHTIN' DRAG
STRADIC GTM-RC 4000		ZINC DIECAST	✓	XT-7			390	4	95	5.8:1	0,30mm-100m	RD II	3	FIGHTIN' DRAG
SUPER GT 2500 RD		ZINC DIECAST	✓	XT-7			290	3	82	5.0:1	0,20mm-240m	RD II	2.5	FIGHTIN' DRAG
SUPER GT 4000 RD		ZINC DIECAST	✓	XT-7			355	3	86	4.8:1	0,25mm-260m	RD II	3	FIGHTIN' DRAG
SAHARA 1000 R		ZINC DIECAST	✓	XT-7			255	3	69	5.2:1	0,20mm-140m	RD II	2	FIGHTIN' DRAG
SAHARA 2500 R		ZINC DIECAST	✓	XT-7			275	3	76	5.2:1	0,25mm-160m	RD II	2	FIGHTIN' DRAG
SAHARA 3000 SR		ZINC DIECAST	✓	XT-7			280	3	76	5.2:1	0,25mm-140m	RD II	2	FIGHTIN' DRAG
SAHARA 4000 R		ZINC DIECAST	✓	XT-7			320	3	82	5.1:1	0,30mm-180m	RD II	3	FIGHTIN' DRAG
SAHARA 2500 DHR		ZINC DIECAST	✓	XT-7			335	3	76	5.2:1	0,25mm-160m	RD II	2	FIGHTIN' DRAG
SAHARA 3000 SSDHHGR		ZINC DIECAST	✓	XT-7			335	3	91	6.2:1	0,18mm-130m	RD II	2	FIGHTIN' DRAG
SAHARA 4000 DHR		ZINC DIECAST	✓	XT-7			375	3	82	5.1:1	0,30mm-180m	RD II	3	FIGHTIN' DRAG
CATANA 1000 RC		ZINC DIECAST	✓	XT-7			270	2	69	5.2:1	0,18mm-170m	RD II	2	
CATANA 2500 RC		ZINC DIECAST	✓	XT-7			300	2	76	5.2:1	0,20mm-240m	RD II	2	
CATANA 3000 SRC		ZINC DIECAST	✓	XT-7			300	2	76	5.2:1	0,18mm-240m	RD II	2	
CATANA 4000 RC		ZINC DIECAST	✓	XT-7			370	2	82	5.1:1	0,30mm-180m	RD II	3	
SIENNA 1000 RE		ZINC DIECAST	✓	XT-7			270	1	69	5.2:1	0,18mm-170m	RD II	2	
SIENNA 2500 RE		ZINC DIECAST	✓	XT-7			300	1	76	5.2:1	0,20mm-240m	RD II	2	
SIENNA 4000 RE		ZINC DIECAST	✓	XT-7			365	1	82	5.1:1	0,25mm-260m	RD II	3	

MODEL	HAGANE GEAR	X-SHIP	HAGANE BODY	BODY MATERIAL	OSCILLATION SPEED	PARALLEL BODY	G- FREE BODY	X-PROTECT	AR-C SPOOL	ONE-PIECE BAIL	WEIGHT (G)	BB QTY	LINE RETRIEVE PER CRANK (CM)	GEAR RATIO	MAX DRAG FORCE (KG)	WATER PROOF DRAG
BIG PIT REELS																
AERO TECHNIUM 14000 XTC				MAGNESIUM	SUPER SLOW 10				✓	✓	485	8	103	4.3:1	20	✓
AERO TECHNIUM 14000 XSC				MAGNESIUM	SUPER SLOW 10				✓	✓	485	8	103	4.3:1	20	✓
POWER AERO 14000 XTB				DIECAST ALU	SUPER SLOW 5				✓	✓	510	8	103	4.3:1	20	✓
POWER AERO 14000 XSB				DIECAST ALU	SUPER SLOW 5				✓	✓	510	8	103	4.3:1	20	✓
FLIENEN SD				DIECAST ALU					✓	✓	490	8	84	3.5:1	20	✓
SURF LEADER CI4+				CI4+					✓	✓	535	4	84	3.5:1	20	✓
ULTEGRA CI4+ 5500 XTC				CI4+	SLOW				✓		440	5	105	5.3:1	15	✓
ULTEGRA CI4+ 14000 XTC				CI4+	SUPER SLOW 5				✓		540	5	103	4.3:1	20	✓
ULTEGRA CI4+ 5500 XSC				CI4+	SLOW				✓		440	5	105	5.3:1	15	✓
ULTEGRA CI4+ 14000 XSC				CI4+	SUPER SLOW 5				✓		540	5	103	4.3:1	20	✓
ULTEGRA 5500 XTD				XT-7	SLOW				✓		500	4	105	5.3:1	15	
ULTEGRA 14000 XTD				XT-7	SUPER SLOW 5				✓		620	4	103	4.3:1	20	
ULTEGRA SPOD				XT-7	SUPER SLOW 5				✓		630	4	124	5.2:1	20	
ULTEGRA 3500 XSD COMPETITION				XT-7	SUPER SLOW 5				✓		645	4	103	4.3:1	20	
ULTEGRA 5500 XSD				XT-7	SLOW				✓		500	4	105	5.3:1	15	
ULTEGRA 14000 XSD				XT-7	SUPER SLOW 5				✓		620	4	103	4.3:1	20	
SPEEDMASTER 14000 XTC				XT-7	SUPER SLOW 5				✓		625	4	103	4.3:1	20	
SPEEDMASTER 14000 XSC				XT-7	SUPER SLOW 5				✓		625	4	103	4.3:1	20	
AERLEX 10000 XTB				XT-7	NORMAL				✓		645	2	100	4.6:1	15	
AERLEX 10000 XTB SPOD				XT-7	NORMAL				✓		650	2	115	5.3:1	15	
AERLEX 10000 XSB				XT-7	NORMAL				✓		645	2	100	4.6:1	15	
BEASTMASTER 10000 XB				XT-7	NORMAL				✓		705	1	100	4.6:1	15	
BAITRUNNER REELS																
MEDIUM BAITRUNNER CI4+ XT-B LC				CI4+	SLOW				✓		510	6	105	5.3:1	15	✓
BIG BAITRUNNER CI4+ XT-B LC				CI4+	SLOW				✓		640	6	110	4.6:1	20	✓
MEDIUM BAITRUNNER XT-B LC				XT-7	SLOW				✓		560	4	105	5.3:1	15	
BIG BAITRUNNER XT-B LC				XT-7	SLOW				✓		720	4	110	4.6:1	20	
BAITRUNNER X-AERO 6000 RA				HYBRID	NORMAL				✓		615	8	96	4.6:1	5	
BAITRUNNER X-AERO 8000 RA				HYBRID	NORMAL				✓		580	6	96	4.6:1	5	
BAITRUNNER X-AERO 10000 RA				HYBRID	NORMAL				✓		590	6	99	4.6:1	5	
BAITRUNNER 4000D				XT-7	NORMAL				✓	✓	385	3	71	4.8:1	7	✓
BAITRUNNER 6000D				XT-7	NORMAL				✓	✓	570	3	89	4.8:1	9	✓
BAITRUNNER 8000D				XT-7	NORMAL				✓	✓	615	3	91	4.8:1	9	✓
BAITRUNNER 12000D				XT-7	NORMAL				✓	✓	850	3	93	4.4:1	12	✓
BAITRUNNER 6000D EU MODEL				XT-7	NORMAL				✓	✓	550	3	89	4.8:1	9	✓
BAITRUNNER 8000D EU MODEL				XT-7	NORMAL				✓	✓	600	3	91	4.8:1	9	✓
BAITRUNNER 4000 OCEANIC				XT-7	NORMAL				✓	✓	380	3	71	4.8:1	7	✓
BAITRUNNER 6000 OCEANIC				XT-7	NORMAL				✓	✓	545	3	89	4.8:1	9	✓

REEL SPECIFICATIONS

MODEL	HAGANE GEAR	X-SHIP	HAGANE BODY	BODY MATERIAL	OSCILLATION SPEED	PARALLEL BODY	G-FREE BODY	X-PROTECT	AR-C SPOOL	ONE-PIECE BAIL	WEIGHT (G)	BB QTY	LINE RETRIEVE PER CRANK (CM)	GEAR RATIO	MAX DRAG FORCE (KG)	WATER PROOF DRAG
BAITRUNNER 8000 OCEANIC				XT-7	NORMAL				✓		590	3	91	4.8:1	9	✓
BAITRUNNER 12000 OCEANIC				XT-7	NORMAL				✓		825	3	93	4.4:1	12	✓
BAITRUNNER XT 6000 RB				HYBRID	NORMAL				✓		610	3	85	4.8:1	8	
BAITRUNNER XT 8000 RB				HYBRID	NORMAL				✓		610	4	87	4.6:1	6	
BAITRUNNER XT 10000 RB				HYBRID	NORMAL				✓		610	4	88	4.6:1	6	
BAITRUNNER DL 6000 RB				XT-7	NORMAL				✓		590	3	85	4.6:1	6	
BAITRUNNER DL 10000 RB				XT-7	NORMAL				✓		595	3	87	4.6:1	6	
BAITRUNNER DL 2500 FB				XT-7	NORMAL				✓		360	3	68	4.8:1	3	
BAITRUNNER DL 4000 FB				XT-7	NORMAL				✓		415	3	75	4.8:1	6	
BAITRUNNER ST 6000 RB				XT-7	NORMAL				✓		550	1	85	4.6:1	6	
BAITRUNNER ST 10000 RB				XT-7	NORMAL				✓		555	1	87	4.6:1	6	
BAITRUNNER ST 2500 FB				XT-7	NORMAL				✓		310	1	68	4.8:1	3	
BAITRUNNER ST 4000 FB				XT-7	NORMAL				✓		355	1	75	4.8:1	6	

MODEL	BRAKE SYSTEM	MICRO MODULE	X-SHIP	HAGANE BODY	EXCITING DRAG SOUND	BODY MATERIAL	WEIGHT (G)	BB QTY	LINE RETRIEVE PER WINCH (CM)	GEAR RATIO	MAX DRAG FORCE (KG)
BAITCASTING REELS											
OCEA CONQUEST 201 PG	SVS				✓	ALUMINUM	275	12	60	4.8:1	6
OCEA CONQUEST 301 HG					✓	ALUMINUM	345	10	84	6.2:1	7
OCEA CONQUEST 301 PG					✓	ALUMINUM	340	10	65	4.8:1	8
CALCUTTA CONQUEST 301A	SVS				✓	ALUMINUM	330	12	84	6.2:1	7
CARDIFF 201 A	YES					ALUMINUM	230	4	61	5.8:1	5
CARDIFF 301 A	YES					ALUMINUM	252	4	61	5.8:1	5
CARDIFF 401 A	YES					ALUMINUM	337	4	56	5.2:1	5
CORVALUS 401	YES					ALUMINUM	335	3	64	5.2:1	5
METANIUM DC 101 HG	AVCS					MAGNESIUM	190	9	79	7.4:1	5
METANIUM DC 101 XG	AVCS					MAGNESIUM	195	9	91	8.5:1	5
CURADO DC 151	AVCU					ALU + C14+	220	6	66	6.2:1	5
CURADO DC 151 HG	AVCU					ALU + C14+	220	6	79	7.4:1	5
CURADO DC 151 XG	AVCU					ALU + C14+	225	6	91	8.5:1	5
SLX DC 151	AVCU					ALU FRAME + HIGH STR RESIN	215	4	67	6.2:1	5.5
SLX DC 151 HG	AVCU					ALU FRAME + HIGH STR RESIN	215	4	77	6.3:1	5
SLX DC 151 XG	AVCU					ALU FRAME + HIGH STR RESIN	215	4	88	7.2:1	5
ALDEBARAN MGL 51	SV2					MAGNESIUM	135	9	65	6.5:1	4.5
ALDEBARAN MGL 51 HG	SV2					MAGNESIUM	135	9	74	7.4:1	4.5
METANIUM MGL 151	SV2					MAGNESIUM	180	10	66	6.2:1	5
METANIUM MGL 151 HG	SV2					MAGNESIUM	180	10	76	7.1:1	5
METANIUM MGL 151 XG	SV2					MAGNESIUM	185	10	86	8.1:1	5
BANTAM MGL 151	SV2					ALUMINUM	215	8	66	6.2:1	5
BANTAM MGL 151 HG	SV2					ALUMINUM	220	8	76	7.1:1	5
BANTAM MGL 151 XG	SV2					ALUMINUM	225	8	86	8.1:1	5
CURADO MGL K 71HG	SV2					C14+	195	8	74	7.4:1	5.5
CURADO MGL K 71XG	SV2					C14+	195	8	81	8.1:1	5.5
SLX MGL 71 HG	SV2					ALUMINUM	200	4	72	7.2:1	5.5
SLX MGL 71 XG	SV2					ALUMINUM	200	4	82	8.2:1	5.5
CURADO 201 K	SV2					ALU + C14+	215	6	66	8.2:1	5
CURADO 201 K PG	SV2					ALU + C14+	220	6	53	5.0:1	5
CURADO 201 K HG	SV2					ALU + C14+	215	6	79	7.4:1	5
SLX XT 151	SV2					ALU FRAME + HIGH STR RESIN	205	4	63	6.3:1	5.5
SLX XT 151 HG	SV2					ALU FRAME + HIGH STR RESIN	205	4	72	7.2:1	5
SLX XT 151 XG	SV2					ALU FRAME + HIGH STR RESIN	205	4	82	8.2:1	5
GRAPPLER BB 201HG	SVS					C14+	185	4	77	7.2:1	5.5
ALDEBARAN BFX XG LEFT	FTB				✓	MAGNESIUM	130	9	80	8.0:1	3.5
TRANX 301 A (LH)	YES					ALUMINUM	330	5	75	5.8:1	10
TRANX 301 A HG (LH)	YES					ALUMINUM	330	5	100	7.6:1	8
TRANX 401 A HG (LH)	YES					ALUMINUM	340	5	100	7.6:1	8
TRANX 401 A (LH)	YES					ALUMINUM	340	5	75	5.8:1	10
CURADO 301 K	YES					ALU FRAME + HIGH STR RESIN	300	6	63	4.7:1	10
CURADO 301 K HG	YES					ALU FRAME + HIGH STR RESIN	305	6	88	6.6:1	8
SLX 151	YES					ALU FRAME + HIGH STR RESIN	195	3	63	6.3:1	5
SLX 151 HG	YES					ALU FRAME + HIGH STR RESIN	195	3	72	7.2:1	5
SLX 151 XG	YES					ALU FRAME + HIGH STR RESIN	195	3	82	8.2:1	5
CAIUS 151 A (LH)	YES					XT-7	210	3	76	7.2:1	5
GENPU XT 200 PG						XT-7	195	3	59	5.5:1	5.5
GENPU XT 201 PG						XT-7	195	3	59	5.5:1	5.5

MODEL	HAGANE GEAR	X-SHIP	HAGANE BODY	INFINITY DRIVE	SILENTDRIVE	BODY MATERIAL	X-SHIELD	X-PROTECT	SPOOL MATERIAL /TYPE	HEAT SINK DRAG	WEIGHT (G)	BB QTY	LINE RETRIEVE PER CRANK(CM)	GEAR RATIO	DRAG TYPE	MAX DRAG FORCE(KG)	WATER PROOF DRAG
HEAVY DUTY REELS																	
STELLA SW-C 4000 HGC	☑	☑	☑	☑	☑	ALU	☑	☑	CF ALU (TI LIP)		355	12	93	5.7:1	☑	11	☑
STELLA SW-C 4000 XGC	☑	☑	☑	☑	☑	ALU	☑	☑	CF ALU (TI LIP)		355	12	101	6.2:1	☑	11	☑
STELLA SW-C 5000 HGC	☑	☑	☑	☑	☑	ALU	☑	☑	CF ALU (TI LIP)		420	13	97	5.7:1	☑	13	☑
STELLA SW-C 5000 XGC	☑	☑	☑	☑	☑	ALU	☑	☑	CF ALU (TI LIP)		420	13	105	6.2:1	☑	13	☑
STELLA SW-C 6000 PGC	☑	☑	☑	☑	☑	ALU	☑	☑	CF ALU (TI LIP)		425	13	83	4.7:1	☑	13	☑
STELLA SW-C 6000 HGC	☑	☑	☑	☑	☑	ALU	☑	☑	CF ALU (TI LIP)		425	13	103	5.7:1	☑	13	☑
STELLA SW-C 6000 XGC	☑	☑	☑	☑	☑	ALU	☑	☑	CF ALU (TI LIP)		425	13	112	6.2:1	☑	13	☑
STELLA SW-C 8000 HG	☑	☑	☑	☑	☑	ALU	☑	☑	CF ALU (TI LIP)		625	13	107	5.6:1	☑	25	☑
STELLA SW-C 8000 PG	☑	☑	☑	☑	☑	ALU	☑	☑	CF ALU (TI LIP)		625	13	94	4.9:1	☑	25	☑
STELLA SW-C 10000 PG	☑	☑	☑	☑	☑	ALU	☑	☑	CF ALU (TI LIP)	☑	670	13	102	4.9:1	☑	25	☑
STELLA SW-C 14000 XG	☑	☑	☑	☑	☑	ALU	☑	☑	CF ALU (TI LIP)	☑	675	13	134	6.2:1	☑	25	☑
STELLA SW-C 18000 HGC	☑	☑	☑	☑	☑	ALU	☑	☑	CF ALU (TI LIP)	☑	875	13	129	5.7:1	☑	25	☑
STELLA SW-C 20000 PGC	☑	☑	☑	☑	☑	ALU	☑	☑	CF ALU (TI LIP)	☑	885	13	104	4.4:1	☑	25	☑
STELLA SW-C 30000 C	☑	☑	☑	☑	☑	ALU	☑	☑	CF ALU (TI LIP)	☑	975	13	131	4.4:1	☑	25	☑
TWINPOWER SW-B 4000 XG	☑	☑	☑			ALU	☑		CF ALU (TI COAT)		355	11	95	6.2:1	FD	11	☑
TWINPOWER SW-B 5000 XG	☑	☑	☑			ALU	☑		CF ALU (TI COAT)		420	11	105	6.2:1	☑	13	☑
TWINPOWER SW-B 8000 PG	☑	☑	☑			ALU	☑		CF ALU (TI COAT)		635	10	94	4.9:1	☑	28	☑
TWINPOWER SW-B 10000 PG	☑	☑	☑			ALU	☑		CF ALU (TI COAT)		650	10	102	4.9:1	☑	25	☑
TWINPOWER SW-B 14000 XG	☑	☑	☑			ALU	☑		CF ALU (TI COAT)		650	10	134	6.2:1	☑	25	☑
SARAGOSA SW A 5000XG	☑	☑	☑	☑		ALU	☑	☑	CF ALU		450	5	105	6.2:1	FD	10	☑
SARAGOSA SW A 6000HG	☑	☑	☑	☑		ALU	☑	☑	CF ALU		455	5	103	5.7:1	FD	10	☑
SARAGOSA SW A 8000HG	☑	☑	☑	☑		ALU	☑	☑	CF ALU		675	5	107	5.6:1	FD	12.3	☑
SARAGOSA SW A 10000PG	☑	☑	☑	☑		ALU	☑	☑	CF ALU		685	5	94	4.9:1	FD	15	☑
SARAGOSA SW A 14000XG	☑	☑	☑	☑		ALU	☑	☑	CF ALU		710	5	135	6.2:1	FD	15	☑
SARAGOSA SW A 18000HG	☑	☑	☑	☑		ALU	☑	☑	CF ALU		915	6	129	5.7:1	FD	22	☑
SARAGOSA SW A 20000PG	☑	☑	☑	☑		ALU	☑	☑	CF ALU		945	6	104	4.4:1	FD	20	☑
SARAGOSA SW A 25000	☑	☑	☑	☑		ALU	☑	☑	CF ALU		970	6	103	4.4:1	FD	20	☑
SPHEROS 3000SW HG	☑	☑	☑			ALU	☑		CF ALU		245	3	88	6.0:1	FD	9	☑
SPHEROS 3000SW XG	☑	☑	☑			ALU	☑		CF ALU		255	3	91	6.2:1	FD	9	☑
SPHEROS 4000SW XG	☑	☑	☑			ALU	☑		CF ALU		280	3	99	6.2:1	FD	11	☑
SPHEROS 5000SW	☑	☑	☑			HYBRID	☑		CF ALU		455	4	78	4.6:1	FD	10	☑
SPHEROS 6000SW	☑	☑	☑			HYBRID	☑		CF ALU		460	4	83	4.6:1	FD	10	☑
SPHEROS 8000SW	☑	☑	☑			HYBRID	☑		CF ALU		700	4	94	4.9:1	FD	12	☑
SPHEROS 10000SW	☑	☑	☑			HYBRID	☑		CF ALU		715	4	102	4.9:1	FD	12	☑
SPHEROS 20000SW	☑	☑	☑			HYBRID	☑		CF ALU		930	4	104	4.4:1	FD	18	☑
SOCORRO 5000 SW	☑	☑	☑			XT-7	☑		CF ALU		440	4	78	4.6:1	FD	10	☑
SOCORRO 6000 SW	☑	☑	☑			XT-7	☑		CF ALU		445	4	83	4.6:1	FD	10	☑
SOCORRO 8000 SW	☑	☑	☑			XT-7	☑		CF ALU		640	4	94	4.9:1	FD	12	☑
SOCORRO 10000 SW	☑	☑	☑			XT-7	☑		CF ALU		665	4	102	4.9:1	FD	12	☑



REEL SPECIFICATIONS

MODEL	BALL BEARING TYPE	SPOOL MATERIAL /TYPE	LEVEL WIND SYSTEM	X-SHIP	HAGANE BODY	BODY MATERIAL	WATER PROTECTION SYSTEM	E.I. TREATMENT	WATERPROOF DRAG	WEIGHT (G)	BB QTY	LINE RETRIEVE PER WINCH	GEAR RATIO	MAXDRAG FORCE (KG)
MULTIPLIER REELS														
TIAGRA A 30 LBS	SHIELDED A-RB	CF ALU				ALUMINUM		✓	✓	1486	4	104/46	3.9:1/1:1.7	15
TIAGRA A 30 LBS W POWER DRAG	SHIELDED A-RB	CF ALU				ALUMINUM		✓	✓	1576	4	104/46	3.9:1/1:1.7	15
TIAGRA A 50 LBS W POWER DRAG	SHIELDED A-RB	CF ALU				ALUMINUM		✓	✓	2447	4	94/38	3.1:1/1:1.3	20
TIAGRA A 80 LBS W	SHIELDED A-RB	CF ALU				ALUMINUM		✓	✓	3266	4	94/48	2.5:1/1:1.3	24
TIAGRA 130 A	SHIELDED A-RB	CF ALU				ALUMINUM		✓	✓	4936	6	99/56	2.1:1/1:1.1	40
TALICA 12 LBS	SHIELDED A-RB	DIECASTED ALU				ALUMINUM		✓	✓	655	6	104	5.7:1	18
TALICA 16 LBS	SHIELDED A-RB	DIECASTED ALU				ALUMINUM		✓	✓	669	6	104	5.7:1	18
TALICA 16 LBS 2 SPEED	SHIELDED A-RB	DIECASTED ALU				ALUMINUM		✓	✓	750	6	104/56	5.7:1/3.1:1	20
TALICA 20 LBS 2 SPEED CAM	SHIELDED A-RB	DIECASTED ALU				ALUMINUM		✓	✓	920	6	104/56	5.2:1/3.1:1	20
TALICA 25 LBS 2 SPEED CAM	SHIELDED A-RB	DIECASTED ALU				ALUMINUM		✓	✓	950	6	104/56	5.2:1/3.1:1	20
TALICA 50 LBS 2 SPEED	SHIELDED A-RB	DIECASTED ALU				ALUMINUM		✓	✓	1588	6	114/53	3.8:1/1:7.1	27
TYRNOS 16 LBS	A-RB	DURALUMINIUM				ALUMINUM				819	4	115	5.0:1	15
TYRNOS 20 LBS	A-RB	DURALUMINIUM				ALUMINUM				1021	4	115	5.0:1	15
TYRNOS 30 LBS	A-RB	DURALUMINIUM				ALUMINUM				1080	4	115	5.0:1	15
TYRNOS 20 LBS 2-SPEED	A-RB	DURALUMINIUM				ALUMINUM				1110	4	115/46	5.0:1/2.0:1	15
TYRNOS 30 LBS 2-SPEED	A-RB	DURALUMINIUM				ALUMINUM				1160	4	115/46	5.0:1/2.0:1	15
TYRNOS 50 LBS 2-SPEED LRS	A-RB	DURALUMINIUM				ALUMINUM				1625	4	111/41	4.0:1/1:5.1	19
TLD15	A-RB	DIECASTED ALU				XT-7				527	4	76	4.0:1	10
TLD20	A-RB	DIECASTED ALU				XT-7				670	4	81	3.6:1	10
TLD25	A-RB	DIECASTED ALU				XT-7				695	4	81	3.6:1	10
TLD 30 II SPEED A	A-RB	DIECASTED ALU				XT-7				1064	4	94/41	4.0:1/1:7.1	15
TLD 50 II SPEED A	A-RB	DIECASTED ALU				XT-7				1624	4	97/38	3.5:1/1:4.1	17
SPEEDMASTER 12LD II	SHIELDED A-RB	DIECASTED ALU				XT-7		✓	✓	730	4	107/58	5.7:1/3.1:1	18
SPEEDMASTER 16LD II	SHIELDED A-RB	DIECASTED ALU				XT-7		✓	✓	750	4	107/58	5.7:1/3.1:1	18
SPEEDMASTER 20LD II	SHIELDED A-RB	DIECASTED ALU				XT-7		✓	✓	980	4	131/58	5.2:1/2.3:1	20
SPEEDMASTER 25LD II	SHIELDED A-RB	DIECASTED ALU				XT-7		✓	✓	1025	4	131/58	5.2:1/2.3:1	20
TR1000LD	A-RB	DIECASTED ALU	✓			XT-7				465	4	66	5.2:1	15
TR2000LD	A-RB	DIECASTED ALU	✓			XT-7				485	4	66	5.2:1	15
TR200	A-RB	DIECASTED ALU	✓			XT-7				374	1	64	4.3:1	6
OCEA JIGGER F CUSTOM 1500 HG	SHIELDED A-RB	CF ALU				ALUMINUM				430	8	98	6.4:1	7
OCEA JIGGER F CUSTOM 1501 HG	SHIELDED A-RB	CF ALU				ALUMINUM				430	8	98	6.4:1	7
OCEA JIGGER F CUSTOM 2000 NR	SHIELDED A-RB	CF ALU				ALUMINUM				605	8	117	6.2:1	10
OCEA JIGGER F CUSTOM 2001 NR	SHIELDED A-RB	CF ALU				ALUMINUM				605	8	117	6.2:1	10
17 OCEA JIGGER 2001 HG	SHIELDED A-RB	CF ALU				ALUMINUM				595	8	117	6.2:1	10
17 OCEA JIGGER 2001 PG	SHIELDED A-RB	CF ALU				ALUMINUM				595	8	96	5.1:1	10
13 OCEA CALCUTTA 301HG/JPN	SHIELDED A-RB	CF ALU				ALUMINUM				350	5	81	6.0:1	6
TORIUM 14A HG	SHIELDED A-RB	CF ALU				ALUMINUM		✓		425	3	97	6.3:1	15
TORIUM 16A HG	SHIELDED A-RB	CF ALU				ALUMINUM		✓		535	3	117	6.2:1	11
TORIUM 20A HG	SHIELDED A-RB	CF ALU				ALUMINUM		✓		545	3	117	6.2:1	11
TORIUM 16AL HG	SHIELDED A-RB	CF ALU				ALUMINUM		✓		535	3	117	6.2:1	11
TORIUM 20AL HG	SHIELDED A-RB	CF ALU				ALUMINUM		✓		545	3	117	6.2:1	11
TEKOTA 301 LC A	SHIELDED A-RB	DIECASTED ALU	✓			ALUMINUM				340	3	89	6.6:1	9
TEKOTA 401 HG LC A	SHIELDED A-RB	DIECASTED ALU	✓			ALUMINUM				340	3	89	6.6:1	11
TEKOTA 500 HG LC Meter A	SHIELDED A-RB	DIECASTED ALU	✓			ALUMINUM				430	3	75	6.3:1	11
TEKOTA 501 HG LC A	SHIELDED A-RB	DIECASTED ALU	✓			ALUMINUM				430	3	75	6.3:1	11
TEKOTA 600 HG A	SHIELDED A-RB	DIECASTED ALU	✓			ALUMINUM				430	3	75	6.3:1	11
TEKOTA 601 HG LC Meter A	SHIELDED A-RB	DIECASTED ALU	✓			ALUMINUM				450	3	75	6.3:1	11
TEKOTA 700LC	A-RB	CF ALU	✓			ALUMINUM				845	3	84	4.2:1	11
ELECTRIC REELS														
BEASTMASTER 9000	SHIELDED A-RB	CF ALU				ALUMINUM				1515	14	88	3.1:1	25
FORCEMASTER 9000	SHIELDED A-RB	CF ALU				ALUMINUM				1515	3	88	3.1:1	25
PLAYS 4000	SHIELDED A-RB	CF ALU				POWER ALU				1270	2	68	3.2:1	15
PLAYS 600	SHIELDED A-RB	CF ALU				XT-7				475	5	59	5.5:1	11

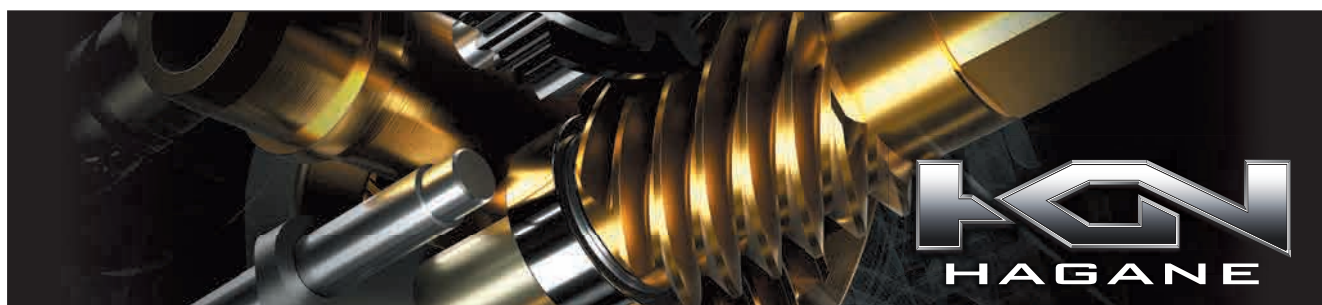

REEL SPECIFICATIONS

FRONT DRAG REELS

REAR DRAG REELS

BIG PIT REELS

BAITRUNNER REELS

BAITCASTING REELS

SALTWATER REELS

MULTIPLIERS

ROD TECHNOLOGY

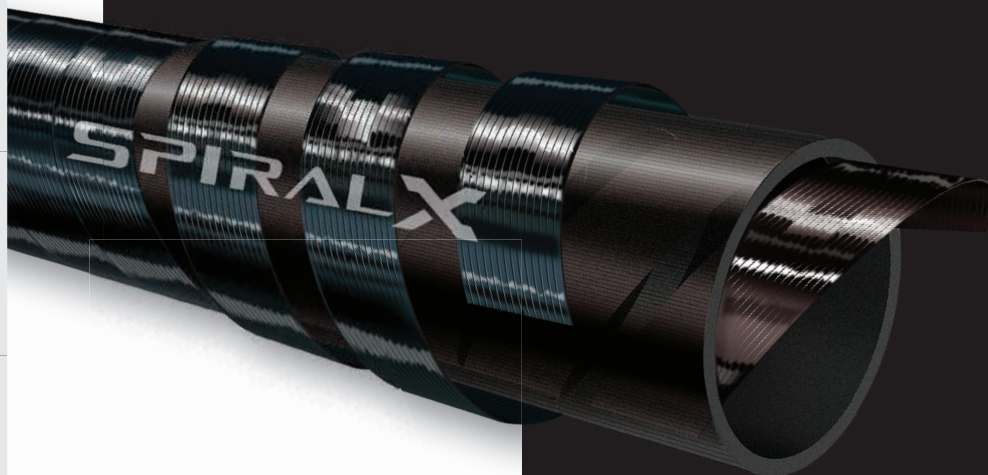

SPIRAL X Core is the newest and most advanced SHIMANO blank construction. The patented SPIRAL X construction is further enhanced by the appli-ance of high-strength carbon infinity tape with Nanoalloy[®] resin technology. Compared to SPIRAL X the torsional and structural rigidity of Spiral X Core is improved by 10-15%. Nanoalloy[®] technology is a registered trademark of Toray.

JDM BLANK CONSTRUCTION

Many SHIMANO rods make use of exclusive carbon technology to achieve lighter, stronger, more responsive rods. This delivers improved performance, which leads to more enjoyment, and ultimately more fish.

The main blank construction technologies are Spiral X Core, Spiral X and Hi-Power X construction.



SPIRAL X construction consists of three layers: a blank made of vertical fibers, an inner layer, and an outer layer both comprised of carbon tape that tightly winds the blank diagonally in opposite directions. By using this carbon tape in place of a conventional horizontal fibre sheet, Spiral X achieves enhanced torsional rigidity without adding extra weight. This in turn facilitates instant power transmission for precise casting and fighting fish.



In **HI-POWER X** construction, the blank's outermost layer is diagonally wrapped with carbon tape, which forms an array of "X" shapes. The width of the tape, its winding angle and the part of the rod being wrapped are fine-tuned according to the target fish species. The flexibility allows SHIMANO to adjust these wraps during construction for precise actions, enhanced overall strength and added twist resistance.

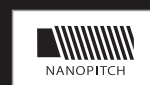

With the **NANOPITCH** manufacturing method SHIMANO is able to wrap a molding tape which is used in the process of baking on a blank finely and with high precision. Because of the NANOPITCH method blanks are tightened up to the extreme while at the same time more uniform pressure is applied, the circularity becomes higher and it contributes greatly to overall rod strength.



FULL CARBON MONOCOQUE is a new dimension grip end structure created from hollow integral molding from the rear of the reel seat to the rear grip. Factors obstructing the transmission of vibrations from the tip of the rod are thoroughly expelled. Compared with the original Carbon Monocoque grip, it achieves increased vibration transmission of 28%.



Among many rod parts, rear grip never have tiny roll in order to catch and transfer delicate and varied information from underwater in an accurate manner. **CARBON MONOCOQUE** grip pursued unprecedented light weight through integrated design by carbon material and hollow structure. As a result, it increases sensibility and succeeds to offer excellent transfer of vibration.

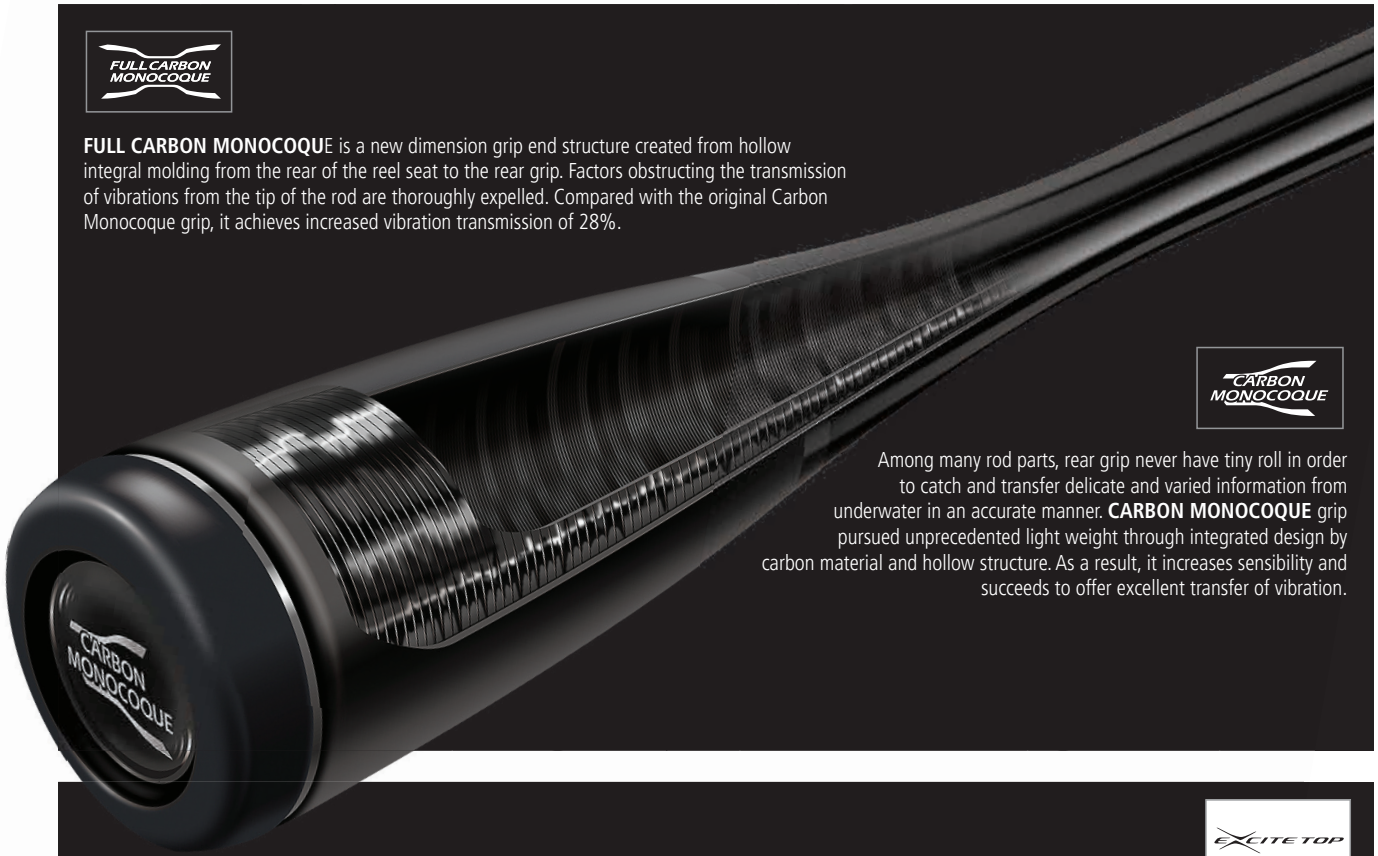

Traditionally, solid carbon tips are made by forming carbon fibre cloth into a solid cylindrical carbon fibre bar, which is then ground to a tapered profile to make the tip. Because the fibres in the carbon cloth are multi-directional they become damaged during the surface grinding process which can weaken the final tip and give inconsistent results. SHIMANO **TAFTEC** tips utilise a pre-stretched T-3500 directional yarn fibre with low resin saturation. This directional alignment of the fibres results in much less damage during the grinding process and results in a spineless construction which tests have shown to be much stronger, lower in weight, faster in action and more sensitive. TAFTEC tips are used throughout the SHIMANO rod range where sensitivity is an important requirement of the rod. of 28%.



EXCITE TOP is a special designed tip that enhances shake performance and sensitivity. The EXCITE TOP is a tapered tip section, which is slightly heavier at the top. This construction expands the swing width of the tip, enabling shaking with an automatic feeling. The movement seen by the eyes, and the sensitivity transmitted to the hands is greatly improved.



SHIMANO **SOFTUBE TOP** provides the sensitivity of an ultra fine solid carbon tip with the lightness of a hollow construction. Softube Top construction can be found on models where sensitivity and finesse are both important requirements. The smooth, seamless action of Softube Top offers the angler an unrivalled experience for bite detection and fish-playing performance.



SHIMANO develop a wide range of reel seat designs to match the rod on which they are applied. Some of the more specialised reel seats incorporate the use of **Ci4** and **Ci4+** carbon. Ci4 is over 20% lighter and 1.6 times stronger than conventional polymers, with Ci4+ being a technical advancement of Ci4 which offers even more strength. This exclusive material allows SHIMANO to make ultra light reel seats, whilst maintaining the maximum strength.



ROD TECHNOLOGY



SHIMANO **HIGH PRESSURE CARBON** is a process which creates stronger, more responsive blanks. Pressure is applied to the blank surface during curing (heating) which evenly distributes the resin through the carbon fibre matrix. The result is a much stronger, more consistent performance and improved response.



DIAFLASH is a reinforced structure that prevents twisting of the butt section in situations where high-intensity is applied, for example during casting and fighting with fish. Due to the effect of DIAFLASH it becomes possible to convey the pulling power of the angler to the target fish while minimizing the loss of energy by flexing of the butt section.

BLANK CONSTRUCTION

Carbon of different modulus is used throughout the SHIMANO rod range, plus blends of composite fibres. In many cases other materials (Biofibre and Geofibre) are also incorporated into the carbon blank. SHIMANO indicate the blank construction using three descriptions - High Modulus Full Carbon, Full Carbon and Composite.

TWIST-CONTROL

TWIST-CONTROL is an anti-twist blank construction process which is a big benefit when fighting huge fish with big game rods.



MUSCLE CARBON is a high-performance material that reduces the gaps between fibers by bundling carbon fibers at a higher density than ordinary carbon materials, and reduces the resin that fills the gaps. More than that, carbon fiber is bundled at high density, and Ultra MUSCLE CARBON is produced only by advanced molding technology.



MUSCLE LOOP is formed using a spiral carbon tape wrapped on the outside of the blank which improves the strength of the rod blank and prevents the blank from distorting under pressure.



BIOFIBRE construction has been renewed offering increased lifting power and excellent control of fighting fish hard close to the bank or boat.



SHIMANO ALIGNMENT SYSTEM is a system to optimise blank action. During the production process the spine of the blank is marked. When assembling the parts according to the marks a constant action is achieved.



GEOFIBRE is a naturally derived component that provides rigidity and high tensile strength when added to rods in the lower to mid-price rod band.



NANOSHEET is a multiple carbon sheet construction using Nanosheet resin distribution technology to ensure all layers of carbon sheet are uniformly bonded together. The result is increased overall rod strength and weight reduction of the blank.

ROD ACTIONS

SHIMANO takes great care when developing rods and designing the correct actions to suit the intended use. As a general guide, Extra Fast and Fast actions offer more sensitivity and hooking speed, plus the ability to cast further with heavy loading. Moderate Fast and Moderate actions offer more flexibility and confidence when playing fish as the action absorbs increased pressure smoothly. Moderate actions are also good for casting very light loading as the rod 'works' through its length to create tip speed.

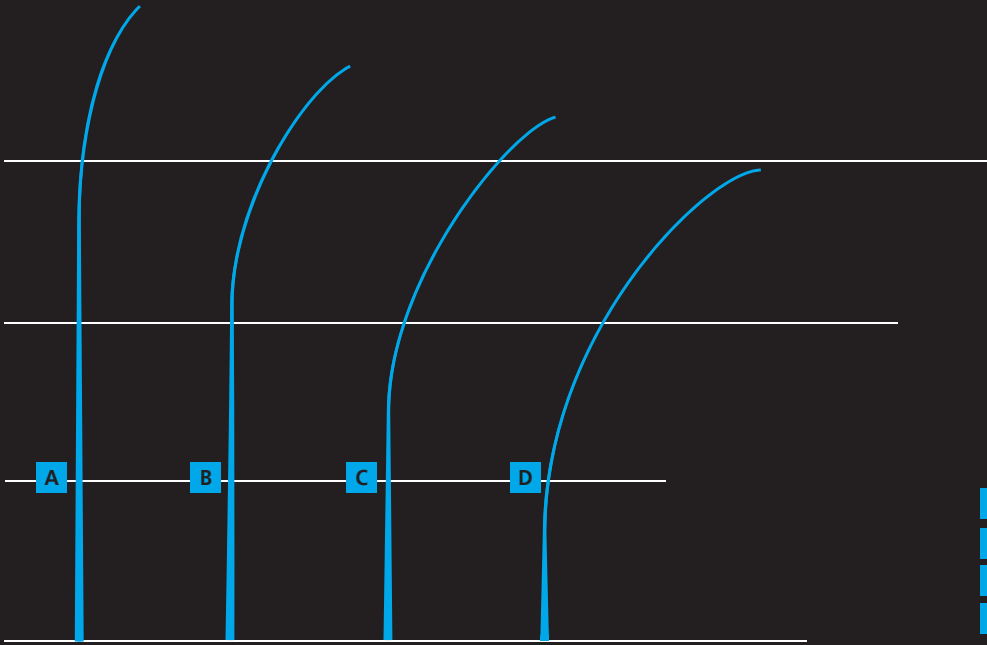

EXTRA-FAST ACTION

A very light and sensitive tip facilitates an effective transfer of energy resulting in effortless pin-point casts, near or far. This action will make any angler a more effective caster.

FAST ACTION

Fast action rods have a light tip that transfers into the power quickly for positive hook sets and effortless repetitive casting. If you are looking for a lure rod to do it all, a fast action rod is a solid choice.

MODERATE-FAST ACTION

The deeper flex associated with this action allows the angler to control the energy of the fish with additional confidence. This action offers an unsurpassable ability land the majority of fish hooked on the lightest tackle.

- A** EXTRA FAST ACTION
- B** FAST ACTION
- C** MODERATE-FAST ACTION
- D** MODERATE ACTION

MODERATE ACTION

Whenever an angler needs the perfect action to absorb the surging power of a fish delivering aggressive headshakes or quick runs, a moderate action rod neutralizes their power.

ROD SPECIFICATION EXPLANATION

Product Code	Length (m)	Transport Length (cm)	Number of Sections	Weight (g)	Casting Weight (g)	Line Rating (lb)	Test Curve	Jig Weight (g)
18PADRN264UL	1.93m	193cm	1	85g	2-7g	20-30lb	2.00	150g
18PADRN267ML	2.01m	201cm	1	92g	4-12g	25-40lb	2.00	150g
18PADRN266L2	1.98m	102cm	2	85g	3-10g	20-30lb	2.50	200g

Product Code

The product code is used by all SHIMANO dealers to identify the model.

Length (m)

This length indicates the length of the rod when it is fully assembled.

Transport Length (cm)

This transport length indicates the length when the rod is not assembled

Number of Sections

The number of sections indicates how many sections the rod has.

Weight (g)

The weight indicates the weight of the rod in grams.

Casting Weight (g)

The casting weight indicates the optimum casting weight for the rod to perform correctly.

Line Rating (lb)

For saltwater rods the line rating is shown in lbs.

Test Curve

For specimen rods the test curve is shown in lbs.

Jig Weight (g)

For jigging rods the ideal jigging weight is shown in grams.



FRESHWATER PREDATOR RODS

SHIMANO freshwater predator rods cover a wide variety of budgets and requirements, from the new high-end Yasei LTD models which are custom designed for specific species and techniques to the remarkably inexpensive FX which offers fantastic value and choice for the inexperienced or younger angler.

For fans of Japanese designed rods, included this year is a range of hand selected JDM models including the world renowned Poison Adrena.

TECHNIQUE SPECIFIC JDM

106 POISON ADRENA

108 EXPRIDE

110 ZODIAS

112 BASS ONE

TECHNIQUE SPECIFIC EU

116 YASEI LTD

118 YASEI

124 YASEI BB

VERSATILE SPINNING

129 LESATH DX

130 SUSTAIN

131 SPEEDMASTER DX · BEASTMASTER FX

132 NORDEN

133 TECHNIUM AX

134 SEDONA

136 CATANA EX

137 VENGEANCE CX · FX XT

138 DIAFLASH BX · VENGEANCE CX





HIGH END JAPANESE DOMESTIC MODELS

To satisfy the demand of anglers looking for high quality, precision engineered tackle, designed for the very latest techniques, the SHIMANO JDM range offers outstanding products. These have been designed and manufactured without compromise, originally for the high-end Japanese market, but now available to anglers throughout Europe.



HIGH-END JAPANESE DESIGN

POISON ADRENA SPINNING / CASTING

- Ultimate high-end Japanese design and construction
- High modulus carbon blank with Spiral X Core and Nanopitch for increased strength and sensitivity
- Full Carbon Monocoque handle increases sensitivity by up to 140%
- Improved ergonomic Ci4+ reel seat (Perfection Seat XT)
- Fuji Stainless Steel SiC-S K-Type plus Titanium SiC tip guide
- Available in both spinning and baitcasting options to suit anglers preference of reel and technique

SPINNING

18PADRN264UL	1.93m	193cm	1	85g	2-7g
18PADRN266L2	1.98m	102cm	2	85g	3-10g
18PADRN267ML	2.01m	201cm	1	92g	4-12g
18PADRN276M2	2.29m	118cm	2	102g	5-15g

CASTING

18PADRN163M	1.91m	191cm	1	95g	7-21g
18PADRN1610M	2.08m	208cm	1	105g	7-21g
18PADRN166MH	1.98m	198cm	1	102g	10-30g
18PADRN172H	2.18m	186cm	2 (SH)*	122g	12-42g

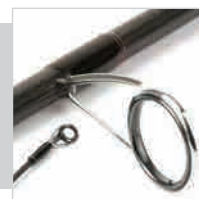



Poison Adrena 267M-2 Spinning

Poison Adrena 166MH Casting

SEARCH YOUR PERFECT MATCH...

Below, we have put together a chart showing what kind of lure is most suited to each model of the Poison Adrena Spinning and Casting range. The stars indicate the rating based on 'Excellent', 'Great' and 'Good'.

- *** = Excellent
- ** = Great
- * = Good

MODEL	SUITABLE LURE WEIGHT (G)	TEXAS RIG	LIGHT TEXAS RIG	HEAVY DROPSHOT	DROPSHOT	RUBBER JIG	SMALL RUBBER JIG	JIG HEAD RIG	JIG HEAD WACKY	NEKO RIG	WEIGHTLESS RIG	SPIRIT SHOT RIG	CAROLINA RIG	CRANKBAIT	LIPLESS CRANKBAIT	MINNOW / JERKBAIT	SHAD BAIT	TOP WATER	SPINNER BAIT	SWIM & BIG BAITS	FROG	
POISON ADRENA SPINNING		SUITABLE PLASTIC WORM & JIG										SUITABLE WOBBLER										
18PADRN264UL	2-7g				***		***	***	***	***	***	*				**	***	***				
18PADRN266L2	3-10g		*		***		***	***	***	***	***	***	*	*	*	***	***	*				
18PADRN267ML	4-12g		**	*	*		**	**	*	*	**	***	***	*	*	***	***	**	**			
18PADRN276M2	5-15g	**	*	***	*		*	***	**	**	**	***	***		***	**	***	***	**			*
POISON ADRENA CASTING		SUITABLE PLASTIC WORM & JIG										SUITABLE WOBBLER										
18PADRN163M	7-21g	**	**	***	*	**		**		*	*	**		**	***	***	**	***	***			
18PADRN1610M	7-21g	**	**	**	*	**				*	*			***	***	***	***	***	***			
18PADRN166MH	10-30g	***	*	**		***									*			*	**			
18PADRN172H	12-42g	***	*	*		***						*	***		*				**	**	***	***



TAKE PRIDE

EXPRIDE SPINNING / CASTING

- High modulus carbon with Hi-Power X construction
- Improved balance for ultimate performance and comfort
- New Ci4+ reel seat with soft-touch rubber coating
- Fuji Stainless SiC guides



SPINNING

17EXPRIDE264UL	1.93m	193cm	1	92g	2-7g
17EXPRIDE265UL	1.96m	196cm	1	92g	2-10g
17EXPRIDE266L2	1.98m	102cm	2	102g	3-10g
17EXPRIDE265ML2	1.96m	101cm	2	95g	4-12g
17EXPRIDE272MH	2.18m	190cm	2 (SH)*	110g	7-21g

CASTING

17EXPRIDE164LBF	1.93m	193cm	1	100g	3.5-10g
17EXPRIDE166M	1.98m	198cm	1	112g	7-21g
17EXPRIDE168MH2	2.03m	104cm	2	120g	10-30g
17EXPRIDE173XH	2.21m	189cm	2 (SH)*	132g	14-56g
17EXPRIDE1711XH	2.41m	206cm	2 (SH)*	162g	14-84g

265UL Only

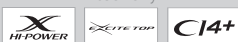



Expride 264UL Spinning

SEARCH YOUR PERFECT MATCH...

Below, we have put together a chart showing what kind of lure is most suited to each model of the Expride Spinning and Casting range. The stars indicate the rating based on 'Excellent', 'Great' and 'Good'.

- *** = Excellent
- ** = Great
- * = Good

MODEL	SUITABLE LURE WEIGHT (G)	TEXAS RIG	LIGHT TEXAS RIG	HEAVY DROPSHOT	DROPSHOT	RUBBER JIG	SMALL RUBBER JIG	JIG HEAD RIG	JIG HEAD WACKY	NEKO RIG	WEIGHTLESS RIG	SPIRIT SHOT RIG	CAROLINA RIG	CRANKBAIT	LIPLESS CRANKBAIT	MINNOW / JERKBAIT	SHAD BAIT	TOP WATER	SPINNER BAIT	SWIM & BIG BAITS	FROG	
EXPRIDE SPINNING		SUITABLE PLASTIC WORM & JIG										SUITABLE WOBBLER										
17EXPRIDE264UL	2-7g				***		***	**	***	***	***	**				***	***					
17EXPRIDE265UL	2-10g				**		***	**	***	***	***	*				***	***					
17EXPRIDE266L2	3-10g		*		**		***	***	***	***	***	***		*	*	***	***	*				
17EXPRIDE265ML2	4-12g		**	*	**	*	**	***	**	***	***	***	*	*	*	***	***	*	*			
17EXPRIDE272MH	7-21g	**	*		**		*	***	*	*	*	*	***	***	***	***	***	*	***	**	*	*
EXPRIDE CASTING		SUITABLE PLASTIC WORM & JIG										SUITABLE WOBBLER										
17EXPRIDE164LBF	3.5-10g		**	*	***		***		***	***	***	*		*	*	**	**	*	*			
17EXPRIDE166M	7-21g	**	**	**	*	*				*	*			**	***	***	**	***	***			
17EXPRIDE168MH2	10-30g	***	**	**		***							**		*			*	**			*
17EXPRIDE173XH	14-56g	**		*		**							**	*	*				**	***	**	**
17EXPRIDE1711XH	14-84g	***		***		***							**	*					*	**		

FAST & EXTRA FAST ACTIONS



NEW

ZODIAS SPINNING / CASTING

- Strong, lightweight Hi-Power X blank construction designed and developed in Japan
- Custom designed fast and extra fast rod actions depending on model
- Carbon Monocoque rear grip for extreme sensitivity
- Custom Ci4+ reel seat for secure reel support
- Fuji Alconite guides with Fuji SiC top guide on Baitcasting models
- Fuji Alconite K type guides on spinning models
- Taftec Alpha solid tip on ULS2 Spinning model



SPINNING

20ZODIAS264ULS2	1.93m	101.5cm	2	90g	1.5-5g
20ZODIAS264UL2	1.93m	101.5cm	2	92g	2-7g
20ZODIAS268L2	2.03m	106.5cm	2	95g	3-10g
20ZODIAS268ML2	2.03m	106.5cm	2	97g	4-12g
20ZODIAS270M2	2.13m	111.5cm	2	107g	5-15g

CASTING

20ZODIAS168LBF	2.03m	175cm	2 (SH)*	97g	4-12g
20ZODIAS1610M	2.08m	179cm	2 (SH)*	110g	7-21g
20ZODIAS172H	2.18m	185cm	2 (SH)*	127g	12-42g
20ZODIAS164LBF2	1.93m	101.5cm	2	92g	4-12g
20ZODIAS1610M2	2.08m	109cm	2	107g	7-21g
20ZODIAS172H2	2.18m	114cm	2	130g	12-42g

264ULS2 Only





Zodias 268L-2 Spinning

Zodias 164L-BFS2 Casting

SEARCH YOUR PERFECT MATCH...

Below, we have put together a chart showing what kind of lure is most suited to each model of the Zodias Spinning and Casting range. The stars indicate the rating based on 'Excellent', 'Great' and 'Good'.

- ★★★ = Excellent
- ★★ = Great
- ★ = Good

MODEL	SUITABLE LURE WEIGHT (G)	TEXAS RIG	LIGHT TEXAS RIG	HEAVY DROPSHOT	DROPSHOT	RUBBER JIG	SMALL RUBBER JIG	JIG HEAD RIG	JIG HEAD WACKY	NEKO RIG	WEIGHTLESS RIG	SPIRIT SHOT RIG	CAROLINA RIG	CRANKBAIT	LIPLESS CRANKBAIT	MINNOW / JERKBAIT	SHAD BAIT	TOP WATER	SPINNER BAIT	SWIM & BIG BAITS	FROG	
ZODIAS SPINNING		SUITABLE PLASTIC WORM & JIG										SUITABLE WOBBLER										
20ZODIAS264UL-S/2	1.5-5g				★★★		★★★	★★	★★★	★★★	★★★	★				★	★					
20ZODIAS264UL-2	2-7g			★★★			★★★	★★★	★★★	★★★	★★★	★		★	★	★★	★★	★				
20ZODIAS268L-2	3-10g		★		★★		★★★	★★★	★★★	★★★	★★★	★★★	★★	★	★	★★★	★★★	★				
20ZODIAS268ML-2	4-12g		★★	★	★★	★	★★	★★★	★★★	★★★	★★★	★★★	★★★	★	★	★★★	★★★	★	★			
20ZODIAS270M-2	5-15g	★	★★	★★★	★★	★	★★★	★★★	★★★	★★★	★★★	★★★	★★★		★★	★★★	★★	★	★			★
ZODIAS CASTING		SUITABLE PLASTIC WORM & JIG										SUITABLE WOBBLER										
20ZODIAS168L-BFS	4-12g		★★	★	★★★		★★★	★★	★★★	★★★	★★★	★★		★★	★★	★★	★★	★	★			
20ZODIAS1610M	7-21g	★★	★★	★★	★	★★				★	★			★★	★★★	★★★	★★	★★★	★★★			
20ZODIAS172H	12-42g	★★★	★	★		★★★							★★★	★	★★	★★	★★	★	★★★	★	★★	
20ZODIAS164L-BFS/2	4-12g		★★	★★	★★	★★★	★★★		★★★	★★★	★★★	★		★★	★★	★★	★★	★★	★	★★		
20ZODIAS1610M-2	7-21g	★★	★★	★★	★	★★				★	★			★★	★★★	★★★	★★	★★★	★★★			
20ZODIAS172H-2	12-42g	★★★	★	★		★★★							★★★	★	★★			★	★★★	★	★★	

RESPONSIVE PERFORMANCE



BASS ONE XT SPINNING / CASTING

- Bass One XT is designed for multi-purpose predator fishing
- Look and feel of a high-end rod, but with a very affordable price in both spinning and baitcasting models
- High Modulus Full Carbon blank for responsive performance
- Fuji Concept 'O' guides
- Unique SHIMANO JDM designed reel seat
- Versatile range suitable for fishing ultra light lures (1-5g) up to medium sized lures (35g)



SPINNING

BOXT263UL2	1.90m	98cm	2	97g	1-5g
BOXT266L2	1.98m	102cm	2	100g	2-7g
BOXT266ML2	1.98m	102cm	2	100g	3-10g

CASTING

BOXT162ML2	1.88m	97cm	2	107g	5-14g
BOXT166M2	1.98m	102cm	2	117g	7-21g
BOXT1610MH2	2.08m	107cm	2	125g	10-28g
BOXT1610H2	2.08m	107cm	2	122g	12-35g

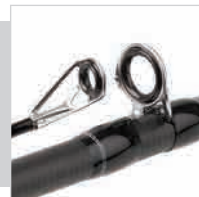



Bass One XT 266L Spinning

Bass One XT 162 ML-2 Casting

SEARCH YOUR PERFECT MATCH...

Below, we have put together a chart showing what kind of lure is most suited to each model of the Bass One XT Spinning and Casting range. The stars indicate the rating based on 'Excellent', 'Great' and 'Good'.

- ★★★ = Excellent
- ★★ = Great
- ★ = Good

MODEL	SUITABLE LURE WEIGHT (G)	TEXAS RIG	LIGHT TEXAS RIG	HEAVY DROPSHOT	DROPSHOT	RUBBER JIG	SMALL RUBBER JIG	JIG HEAD RIG	JIG HEAD WACKY	NEKO RIG	WEIGHTLESS RIG	SPIRIT SHOT RIG	CAROLINA RIG	CRANKBAIT	LIPLESS CRANKBAIT	MINNOW / JERKBAIT	SHAD BAIT	TOP WATER	SPINNER BAIT	SWIM & BIG BAITS	FROG	
BASS ONE XT SPINNING		SUITABLE PLASTIC WORM & JIG										SUITABLE WOBBLER										
BOXT263UL2	1-5g				★★★		★★★	★★★	★★★	★★★	★★★					★★						
BOXT266L2	2-7g			★	★		★★★	★★★	★★★	★★★	★★★	★★				★★★	★★					
BOXT266ML2	3-10g		★★	★★	★★		★★	★★★	★★	★★★	★★★	★★★	★★	★★		★★★	★★★					
BASS ONE XT CASTING		SUITABLE PLASTIC WORM & JIG										SUITABLE WOBBLER										
BOXT162ML2	5-14g	★	★★	★	★	★	★		★	★	★			★★★		★★★	★★★	★★★	★★★			
BOXT166M2	7-21g	★★	★★	★★	★	★★				★	★			★★	★★★	★★★	★★	★★★	★★★			
BOXT1610MH2	10-28g	★★★	★	★★		★★★									★★	★		★★	★★★		★	★★
BOXT1610H2	12-35g	★★★		★		★★★							★★★	★	★			★	★★★	★★★	★★★	★★★



YASEI

EVERY ROD TELLS A STORY





YASEI LTD BIG SOFTBAIT

- The very best Japanese rod design technology used to create the ultimate high-end specialist pike rods
- Spiral X Core and Nanopitch blank construction for strength and responsive performance
- Fuji SiC K-type guides minimise effect on the rods action and improve casting and retrieve performance
- Carbon Monocoque combined with Cork handle with custom Ci4+ Perfection

YASLTDBSS270XH



2.70m

139cm

2

159g

60-120g

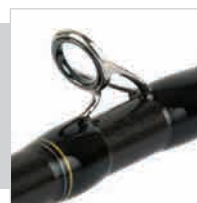

YASEI LTD PIKE

- The very best Japanese rod design technology used to create the ultimate high-end specialist pike rods
- Spiral X Core and Nanopitch blank construction for strength and responsive performance
- Fuji SiC guides minimise effect on the rods action and improve casting and retrieve performance
- Carbon Monocoque combined with Cork handle with custom Ci4+ Perfection / Fuji PTSS reel seats

CRANK & SPINNERBAIT

YASLTDP225XH



2.25m

117cm

2

160g

50-110g

SWIM & SOFTBAIT

YASLTDP255XXH

2.55m

132cm

2

253g

60-180g

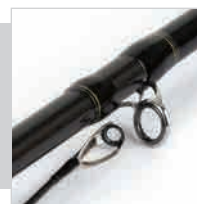



YASEI LTD PERCH

- The very best Japanese rod design technology used to create the ultimate high-end specialist perch rods
- Spiral X Core and Nanopitch blank construction for strength and responsive performance
- Fuji SiC KR-type guides minimise effect on the rods action and improve casting and retrieve performance
- Carbon Monocoque combined with Cork handle with custom Ci4+ Perfection
- Taftec Alpha technology (YASLTDPE225ML & YASLTDPE260ML models only)

CRANKBAIT

YASLTDPE215ML | 2.15m 111cm 2 105g 4-16g

FINESSE SOFTBAIT

YASLTDPE225ML | 2.25m 116cm 2 95g 5-18g

YASLTDPE260ML | 2.60m 134cm 2 116g 3-21g



YASEI LTD ZANDER

- The very best Japanese rod design technology used to create the ultimate high-end specialist zander rods
- Spiral X Core and Nanopitch blank construction for strength and responsive performance
- Fuji SiC K-type guides minimise effect on the rods action and improve casting and retrieve performance
- Carbon Monocoque combined with Cork handle with custom Ci4+ Perfections

VERTICAL JIGGING

YASLTDVZA198M | 1.98m 168cm 2 98g 12-28g

RIVER JIGGING

YASLTDZA270H | 2.70m 139cm 2 149g 20-70g

FINESSE JIGGING

YASLTDZA270M | 2.70m 139cm 2 138g 10-35g





NEW MODELS

YASEI PIKE CASTING

- Highly responsive and incredibly light High Modulus Full Carbon + HPC + Nanosheet blank designed for use with baitcasting reels and larger lures of all types
- Fuji Stainless Steel Alconite K-Type guides
- Fuji PSS Palming reel seat with split EVA handle
- For use with large and extra large Crankbaits, Softbaits, Spoons, Jerkbait, Hybrid Baits and Spinnerbaits

YASPIC21H	2.10m	169cm	2(SH)*	120g	20-60g	NEW
YASPIC23XXH	2.30m	189cm	2(SH)*	190g	56-170g	
YASPIC25XH	2.50m	128cm	2	146g	40-100g	
YASPIC250XXH	2.50m	128cm	2	223g	56-170g	NEW
YASPIC26	2.60m	133cm	2	269g	120-270g	
CORK HANDLE						
YASPIC25XHC	2.50m	128cm	2	173g	40-100g	NEW
YASPIC250XXHC	2.50m	128cm	2	262g	56-170g	NEW



NEW MODEL

YASEI PIKE SPINNING

- Highly responsive and incredibly light High Modulus Full Carbon + HPC + Nanosheet blank with excellent casting performance and hidden power for fishing close to structure
- Fuji Stainless Steel Alconite K-Type guides
- SHIMANO designed custom reel seat with split EVA handle
- For use with small and medium Crankbaits, Softbaits, Spoons, Jerkbait, Hybrid Baits and Spinnerbaits

YASPI21H	2.10m	169cm	2(SH)*	119g	20-60g	
YASPI25XH	2.50m	128cm	2	138g	40-100g	
CORK HANDLE						
YASPI25XHC	2.50m	129cm	2	156g	40-100g	NEW





YASEI DROPSHOT LIGHT JIG

- Highly responsive and incredibly light High Modulus Full Carbon + HPC + Nanosheet blank with soft tip designed for Dropshot and light Jigging
- Fuji Stainless Steel Alconite K-Type guides
- SHIMANO designed custom reel seat with tapered front part for sensitivity and split EVA handle
- For use with Dropshot and light Jigging

YASDS210ML	2.10m	178cm	2(SH)*	96g	5-18g
YASDS240M	2.40m	124cm	2	124g	7-21g



YASEI FINESSE JIG & DROPSHOT

- Highly responsive High Modulus Full Carbon + HPC + Nanosheet blank with exceptional sensitivity designed for lightweight jig and dropshot fishing
- Fuji Stainless Steel Alconite K-Type guides
- SHIMANO designed custom reel seat with split EVA handle
- Extremely lightweight blank balances perfectly with a SHIMANO 1000 reel for street fishing

YASDS205L	2.05m	105cm	2	88g	3-12g
-----------	-------	-------	---	-----	-------





YASEI PERCH TWITCH & JERK

- Highly responsive and incredibly light High Modulus Full Carbon + HPC + Nanosheet blanks, designed for use with Baitcasting reels
- Fuji Stainless Steel Alconite K-Type guides
- SHIMANO designed custom reel seat and split EVA handle
- Perfect for perch fishing with Twitch and Jerkbait type lures

YASPTJ203L	2.03m	106cm	2	92g	5-12g
YASPTJ215LP	2.15m	110cm	2	106g	9-18g



NEW MODELS

YASEI PERCH

- Highly responsive and incredibly light High Modulus Full Carbon + HPC + Nanosheet blanks, perfect for street fishing
- Fuji Stainless Steel Alconite K-Type guides
- SHIMANO designed custom reel seat and split EVA handle
- For use with small Jigs, Spinners, Crankbaits and Dropshot

YASP195L	1.95m	168cm	2(SH)*	87g	3-12g	
YASP210ML	2.10m	180cm	2(SH)*	94g	7-18g	NEW
CORK HANDLE						
YASP210MLC	2.10m	109cm	2	119g	7-18g	NEW
YASP225MC	2.25m	116cm	2(SH)*	130g	10-25g	NEW





YASEI ASPIUS

- Highly responsive high modulus full carbon + HPC + Nanosheet blank with exceptional strength designed for Aspius fishing
- Fuji Stainless Steel Alconite K-Type guides
- SHIMANO designed custom reel seat with split EVA handle
- Excellent long range casting performance to reach feeding asp at distance using crankbaits and top water lures

YASASP27MH

2.70m
 139cm
 2
 148g
 10-35g



NEW MODEL

YASEI JERKBAIT

- Highly responsive and incredibly light High Modulus Full Carbon + HPC + Nanosheet blank designed to put maximum life into Jerkbait
- Fuji Stainless Steel Alconite K-Type guides
- SHIMANO designed custom reel seat with split EVA handle
- For use with medium and large Jerkbait, trolling and Crankbaits

YASJBC198H
CORK HANDLE
YASJBC198HC

1.98m
 160cm
 2(SH)*
 162g
 45-100g

NEW





YASEI CRANKBAIT

- Highly responsive and incredibly light High Modulus Full Carbon + HPC + Nanosheet blank designed for long range casting of small and medium Crankbaits
- Fuji Stainless Steel Alconite K-Type guides
- SHIMANO designed custom reel seat with split EVA handle
- For use with small and medium Crankbaits

YASCR22M

2.20m	112cm	2	110g	8-24g



NEW MODEL

YASEI ZANDER SHAD

- Highly responsive and incredibly light High Modulus Full Carbon + HPC + Nanosheet blank designed for jighead fishing from the bank or casting from a boat
- Fuji Stainless Steel Alconite K-Type guides
- SHIMANO designed custom reel seat with split EVA handle
- For use with softbaits ranging in size from 10g (Medium model) up to 56g (Heavy model)

YASZS24M

YASZS27M

YASZS27H

					NEW
2.40m	124cm	2	120g	12-28g	
2.70m	138.5cm	2	137g	12-28g	
2.70m	138.5cm	2	161g	24-56g	





YASEI ZANDER VERTICAL JIG

- Highly responsive and incredibly light High Modulus Full Carbon + HPC + Nanosheet blank with a sensitive tip for maximum feel
- Fuji Stainless Steel micro guides for sensitivity and lightness
- SHIMANO designed custom reel seat with split EVA handle
- Separate handle for improved playing action
- For use with softbaits and Fireball type techniques

YASVJS19	1.90m	162cm	2(SH)*	103g	14-28g
YASVJC19	1.90m	163cm	2(SH)*	101g	14-28g



YASEI ZANDER DEADBAIT

- Highly responsive and incredibly light High Modulus Full Carbon + HPC + Nanosheet blank with a 'classic' parabolic through action
- Fuji Stainless Steel Alconite K-Type guides
- SHIMANO designed custom reel seat with split EVA handle
- For use with small and medium Deadbaits

YASZDB27	2.70m	139cm	2	162g	5-15g
----------	-------	-------	---	------	-------





EVERY ROD TELLS A STORY



NEW

YASEI BB ZANDER VERTICAL

- Fast action for vertical jigging with softbaits
- Responsive, lightweight, strong Full Carbon + HPC blanks
- Part of the acclaimed Yasei custom range offering excellent value
- Custom designed actions depending on intended use
- Spinning models have split cork/EVA handle with SHIMANO VSS reel seat
- Anti-tangle Seaguide XOG guides for improved casting



YASBBZV195



1.95m



100.5cm



2



110g



10-30g

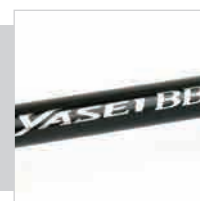



NEW

YASEI BB ZANDER LURE

- Extra fast action for jigging with softbaits
- Responsive, lightweight, strong Full Carbon + HPC blanks
- Part of the acclaimed Yasei custom range offering excellent value
- Custom designed actions depending on intended use
- Spinning models have split cork/EVA handle with SHIMANO VSS reel seat
- Anti-tangle Seaguide XOG guides for improved casting



YASBBZL270H



2.70m



138.5cm



2



165g



15-50g

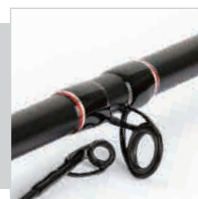



NEW

YASEI BB CAST & TROLL

- Fast action for trolling and casting with large hardbaits and softbaits
- Responsive, lightweight, strong Full Carbon + HPC blanks
- Baitcasting models have split cork/EVA handle, EVA front grip with SHIMANO custom BC reel seat
- Anti-tangle Seaguide XOG guides for improved casting



YASBBP250XXH



2.50m



128.5cm



2



165g



50-120g



NEW

YASEI BB PIKE SPIN

- Fast action for use with hardbaits, softbaits and spinners
- Responsive, lightweight, strong Full Carbon + HPC blanks
- Spinning models have split cork/EVA handle with SHIMANO VSS reel seat
- Anti-tangle Seaguide XOG guides for improved casting



YASBBP230H



2.30m



118.5cm



2



141g



15-50g

YASBBP250XH



2.50m



128.5cm



2



153g



30-90g



NEW

YASEI BB PIKE CASTING

- Fast action for use with medium and large hardbaits and softbaits
- Responsive, lightweight, strong Full Carbon + HPC blanks
- Baitcasting models have split cork/EVA handle, EVA front grip with SHIMANO custom BC reel seat
- Anti-tangle Seaguide XOG guides for improved casting



YASBBP230XH



2.30m



118.5cm



2



153g



30-90g



NEW

YASEI BB PIKE JERKBAIT

- Extra fast action for use with medium and large jerkbaits
- Responsive, lightweight, strong Full Carbon + HPC blanks
- Baitcasting models have split cork/EVA handle, EVA front grip with SHIMANO custom BC reel seat
- Anti-tangle Seaguide XOG guides for improved casting



YASBBCJB195HP



1.95m



100.5cm



2



140g



30-75g



NEW

YASEI BB ASPIUS

- Fast action for long range casting with hardbaits and spoons
- Responsive, lightweight, strong Full Carbon + HPC blanks
- Spinning models have split cork/EVA handle with SHIMANO VSS reel seat
- Anti-tangle Seaguide XOG guides for improved casting



YASBBASP270MH



2.70m



138.5cm



2



143g



10-35g



NEW

YASEI BB CRANKBAIT

- Moderate fast action for use with small and medium crankbaits
- Responsive, lightweight, strong Full Carbon + HPC blanks
- Baitcasting models have split cork/EVA handle, EVA front grip with SHIMANO custom BC reel seat
- Anti-tangle Seaguide XOG guides for improved casting



YASBBCCR230



2.30m



118.5cm



2



118g



5-20g



NEW

YASEI BB PERCH

- Fast action for lightweight lure fishing for perch
- Responsive, lightweight, strong Full Carbon + HPC blanks
- Spinning models have split cork/EVA handle with SHIMANO VSS reel seat
- Anti-tangle Seaguide XOG guides for improved casting



YASBBPER190L



1.90m



98cm



2



91g



3-12g



NEW

YASEI BB STREET

- Fast action for lightweight 'Street' lure fishing
- Responsive, lightweight, strong Full Carbon + HPC blanks
- Spinning models have split cork/EVA handle with SHIMANO VSS reel seat
- Anti-tangle Seaguide XOG guides for improved casting



YASBBST190ULP

YASBBST210L

YASBBST225ML



1.90m



98cm



2



90g



2-10g



2.10m



108.5cm



2



103g



3-12g



2.25m



116cm



2



110g



5-15g

VERSATILE SPINNING

MULTI PIECE SPINNING • TELESCOPIC SPINNING • SUPER SENSITIVE



ULTIMATE PRECISION



LESATH DX

- The number one rod for all-round lure fishing. Extremely light in weight makes it suitable for casting big distances with ultimate precision
- Blank has a fast-progressive action with very fast recovery speed
- Spiral X construction for reduced torsion and ovalisation and Hi-Power X construction for reduced blank twist and strength results in a very strong, stiff and lightweight blank with incredible casting performance (both distance and accuracy)
- Lightweight SHIMANO Ci4+ reel seat for perfect placement of the reel
- Ultra light Fuji Titanium Torzite guides



SLEDX21M	2.10m	107cm	2	122g	7-28g
SLEDX24M	2.40m	124cm	2	127g	7-28g
SLEDX24MH	2.40m	124cm	2	140g	14-42g
SLEDX27ML	2.70m	139cm	2	152g	7-21g
SLEDX27M	2.70m	139cm	2	155g	7-28g
SLEDX27MH	2.70m	139cm	2	167g	14-42g
SLEDX27H	2.70m	139cm	2	172g	21-56g
SLEDX27XH	2.70m	139cm	2	182g	42-84g
SLEDX30M	3.00m	154cm	2	170g	7-28g
SLEDX86XHINT	2.59m	133cm	2	195g	45-135g

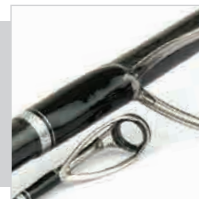

STIFF WITH POWER

SUSTAIN AX SPINNING / CASTING

- Hi-Power X construction for reduced blank twist and greater rod strength
- Strong, stiff and light rod blank for excellent casting distance and accuracy
- Lightweight Ci4+ reel seat for perfect fixation of the reel
- Fast action in the tip makes it suitable for sensitive fishing
- Versatile rod series for twitching, jigging, jerking
- Very powerful and fast rod, built for modern lure fishing and capable of fighting very big fish



SPINNING

SSUSAX61L	1.85m	155cm	2 (SH)*	85g	3-14g
SSUSAX63ML	1.90m	161cm	2 (SH)*	92g	7-21g
SSUSAX610M	2.08m	179cm	2 (SH)*	115g	14-35g
SSUSAX70MH	2.13m	183cm	2 (SH)*	122g	14-42g
SSUSAX78M	2.33m	121cm	2	115g	7-35g
SSUSAX710MH	2.38m	124cm	2	125g	14-42g
SSUSAX82H	2.49m	129cm	2	145g	21-56g
SSUSAX86XXHSS	2.59m	134cm	2	185g	45-135g
SSUSAX810M	2.69m	139cm	2	138g	7-35g
SSUSAX90H	2.74m	142cm	2	175g	14-56g
SSUSAX90XH	2.74m	142cm	2	190g	28-84g
SSUSAX910H	3.00m	156cm	2	200g	21-56g

CASTING

CSUSAX63M	1.90m	162cm	2 (SH)*	105g	14-35g
CSUSAX70H	2.13m	179cm	2 (SH)*	115g	21-56g
CSUSAX610XH	2.08m	173cm	2 (SH)*	142g	28-84g
CSUSAX72XXH	2.18m	179cm	2 (SH)*	160g	56-135g

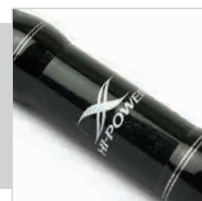
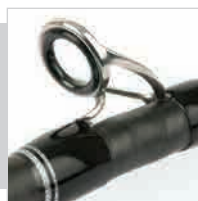

VERSATILE SPINNING RODS



SpeedMaster DX

- Slim, lightweight, responsive High Modulus Full Carbon + HPC + Nanosheet blank designed for a wide range of lure fishing techniques
- Fuji Stainless Steel Alconite K-Type for improved blank action
- Classic retro look designed with special custom reel seat and full cork handle
- Moderate-fast action blanks make the SpeedMaster an all-round rod which is excellent for distance casting

SSMDX18UL	1.80m	93cm	2	98g	2-8g
SSMDX21L	2.10m	108cm	2	115g	3-14g
SSMDX21M	2.10m	108cm	2	121g	7-28g
SSMDX24L	2.40m	123cm	2	132g	3-14g
SSMDX24M	2.40m	123cm	2	138g	7-28g
SSMDX24MH	2.40m	123cm	2	145g	14-42g
SSMDX24HP	2.40m	123cm	2	162g	28-70g
SSMDX27ML	2.70m	138cm	2	147g	5-21g
SSMDX27M	2.70m	138cm	2	160g	7-28g
SSMDX27MH	2.70m	138cm	2	165g	14-42g
SSMDX27H	2.70m	138cm	2	184g	21-56g
SSMDX27XH	2.70m	138cm	2	202g	42-84g
SSMDX30M	3.00m	154cm	2	167g	7-28g
SSMDX30HP	3.00m	154cm	2	204g	28-70g
SSMDX33HP	3.30m	169cm	2	230g	28-70g
SSMDX36HP	3.60m	183cm	2	280g	28-70g



BeastMaster FX

- Redesigned moderate-fast action Full Carbon + Nanosheet blank in the classic Beastmaster black gloss and gold colour scheme
- Fuji Fazlite anti-tangle K Type guides for improved blank action
- Special custom reel seat and ergonomic cork handle complements the understated black blank perfectly
- Available is a wide range of models to suit almost all spinning and lure methods from ultra lightweight jiggling to the largest crankbaits

SBMFXMF165UL	1.65m	85cm	2	81g	1-11g
SBMFXMF18L	1.80m	93cm	2	91g	3-14g
SBMFXMF21ML	2.10m	108cm	2	100g	5-21g
SBMFXMF21M	2.10m	108cm	2	106g	7-28g
SBMFXMF21H	2.10m	108cm	2	126g	21-56g
SBMFXMF24L	2.40m	108cm	2	121g	3-14g
SBMFXMF24ML	2.40m	123cm	2	125g	5-21g
SBMFXMF24M	2.40m	123cm	2	129g	7-28g
SBMFXMF24MH	2.40m	123cm	2	130g	14-42g
SBMFXMF24H	2.40m	123cm	2	140g	21-56g
SBMFXMF24XHP	2.40m	123cm	2	149g	50-120g
SBMFXMF27ML	2.70m	138cm	2	127g	5-21g
SBMFXMF27M	2.70m	138cm	2	135g	7-28g
SBMFXMF27MH	2.70m	138cm	2	152g	14-42g
SBMFXMF27H	2.70m	138cm	2	165g	21-56g
SBMFXMF27XH	2.70m	138cm	2	176g	42-84g
SBMFXMF30M	3.00m	154cm	2	152g	7-28g
SBMFXMF30MH	3.00m	154cm	2	161g	14-42g
SBMFXMF30H	3.00m	154cm	2	176g	21-56g
SBMFXMF33HP	3.30m	168cm	2	204g	28-70g
SBMFXMF36HP	3.60m	183cm	2	217g	28-70g



ROD TECHNOLOGY
SPINNING
TROUT
CATFISH
S.T.C.
SPECIMEN
MATCH & FEEDER
TELESCOPIC
SALTWATER SPINNING
BOAT
SURF

MOBILE CONTROL

NEW

AVAILABLE SPRING 2021

NORDEN SP

- Slim, lightweight, responsive High Modulus Full Carbon + HPC + Nanosheet blank designed for a wide range of lure fishing techniques
- The Norden rod series is developed for anglers who are looking for mobility, but at the same time don't want to sacrifice performance
- Available in 4 piece and 3 piece options, in lengths ranging from 7'0" (2.13m) to 11'0" (3.35m)
- Anti-tangle Seaguide XOG guides for improved casting
- Cork handle with custom designed SHIMANO reel seat
- All rods have an excellent 'special progressive' action, which differs when working lures and when fighting fish, to ensure optimal angler control in each situation



NANOSHEET

NORSP70UL4	2.13m	57cm	4	107g	0.5-7g
NORSP70L4	2.13m	57cm	4	102g	2-10g
NORSP76LP4	2.29m	61cm	4	118g	3-15g
NORSP80ML4	2.44m	65cm	4	131g	5-21g
NORSP80M4	2.44m	65cm	4	136g	7-28g
NORSP86ML4	2.59m	69cm	4	137g	5-21g
NORSP90M4	2.74m	73cm	4	149g	7-28g
NORSP90MP4	2.74m	73cm	4	150g	10-35g
NORSP10MH3	3.05m	106cm	3	196g	10-50g
NORSP11H3	3.35m	116cm	3	220g	20-60g



ALL ROUND ACTION



TECHNIUM AX

- High Modulus Full Carbon blank with fast, strong, powerful and highly responsive action
- Increased tip sensitivity to suit modern lure trends and re-designed balance for improved casting distance
- Fuji Fazlite anti-tangle K/KR guides reduce tangles and increase blank performance
- Fuji TVS reel seat for L/ML/M rods (light and sensitive)
- Fuji VSS reel seat for MH/H/XH/XXH rods (grip and power)

TECAXXF65M	1.95m	167cm	2 (SH)*	99g	7-35g
TECAXXF66L	1.98m	170cm	2 (SH)*	100g	3-14g
TECAXXF68ML	2.03m	107cm	2	100g	7-21g
TECAXXF610M	2.08m	109cm	2	116g	7-35g
TECAXF70MH	2.13m	112cm	2	109g	14-42g
TECAXXF78L	2.33m	122cm	2	113g	3-14g
TECAXXF78ML	2.33m	122cm	2	123g	7-21g
TECAXXF710M	2.38m	124cm	2	128g	7-35g
TECAXF80MH	2.44m	127cm	2	130g	14-42g
TECAXF82H	2.49m	130cm	2	147g	21-56g
TECAXF84XH	2.54m	132cm	2	150g	28-84g
TECAXF86XXHSS	2.59m	135cm	2	169g	45-135g
TECAXXF810ML	2.69m	140cm	2	168g	7-21g
TECAXF810MH	2.69m	140cm	2	169g	14-42g
TECAXF90H	2.74m	142cm	2	171g	21-56g
TECAXF90XH	2.74m	142cm	2	173g	28-84g
TECAXF910H	3.00m	155cm	2	182g	21-56g



VERSATILE RANGE



NEW

SEDONA

- The series consists of a blend of fast-action and moderate-action rods that are perfectly fitted for the modern lure angler
- Reinforced X carbon tape construction (Diaflash) on butt section only, resulting in increased compression strength and impact resistance
- Versatile range of rods for bass, perch, zander and pike
- Special models specifically created for dead baiting and chub fishing
- Full Carbon + Diaflash construction blanks
- Seaguide XOG guides



VERSATILE SPINNING RODS



FAST ACTION EVA HANDLE					
SED61ULFE	1.85m	96cm	2	83g	1-7g
SED63LFE	1.90m	98cm	2	92g	3-14g
SED68MLFE	2.03m	105cm	2	100g	7-21g
SED610MFE	2.08m	107cm	2	112g	7-35g
SED70MHFE	2.13m	110cm	2	126g	14-42g
SED74MLFE	2.23m	115cm	2	108g	7-21g
SED78MFE	2.34m	120cm	2	128g	7-35g
SED710MHFE	2.39m	123cm	2	134g	14-42g
SED80XHFE	2.44m	125cm	2	164g	28-84g
SED82HFE	2.49m	128cm	2	149g	21-56g
SED810MHFE	2.69m	138cm	2	151g	14-42g
SED90HFE	2.74m	140cm	2	167g	21-56g
SED90XHFE	2.74m	140cm	2	168g	28-84g

MODERATE ACTION CORK HANDLE					
SED55ULMFC	1.65m	85cm	2	88g	1-7g
SED611LMFC	2.11m	109cm	2	102g	3-14g
SED611MMFC	2.11m	109cm	2	112g	7-35g
SED711MMFC	2.42m	124cm	2	127g	7-35g
SED711MHMFC	2.42m	124cm	2	132g	14-42g
SED810MMFC	2.69m	138cm	2	140g	7-35g
SED810HMFC	2.69m	138cm	2	155g	21-56g
DEADBAIT					
SEDDBS270H	2.70m	138cm	2	177g	20-60g
SEDDBS270XH	2.70m	138cm	2	180g	30-100g
CHUB SPECIALIST					
SEDCHUB810L	2.69m	138cm	2	131g	5-15g
SEDCHUB910L	2.99m	153cm	2	143g	5-15g



CATANA EX

- Renewed and improved Full Carbon blank for more sensitivity and stiffness
- Blank matches the casting weights perfectly
- Modern and exciting cosmetics
- New Seaguide reel seat with Vibraspot for good bite and vibration detection
- Versatile range of rods for every type of lure fishing

3.0m Models



SCATEX165UL	1.65m	77cm	2	95g	1-11g
SCATEX18L	1.80m	93cm	2	89g	3-14g
SCATEX18MHJ	1.80m	93cm	2	113g	14-40g
SCATEX21UL	2.10m	108cm	2	119g	1-11g
SCATEX21ML	2.10m	108cm	2	138g	7-21g
SCATEX21M	2.10m	108cm	2	151g	10-30g
SCATEX21MH	2.10m	108cm	2	155g	14-40g
SCATEX21H	2.10m	108cm	2	156g	20-50g
SCATEX24UL	2.40m	123cm	2	139g	1-11g
SCATEX24L	2.40m	123cm	2	151g	3-14g
SCATEX24ML	2.40m	123cm	2	164g	7-21g
SCATEX24M	2.40m	123cm	2	172g	10-30g
SCATEX24MH	2.40m	123cm	2	176g	14-40g
SCATEX24H	2.40m	123cm	2	182g	20-50g
SCATEX27L	2.70m	138cm	2	172g	3-14g
SCATEX27ML	2.70m	138cm	2	180g	7-21g
SCATEX27M	2.70m	138cm	2	185g	10-30g
SCATEX27MH	2.70m	138cm	2	198g	14-40g
SCATEX27H	2.70m	138cm	2	197g	20-50g
SCATEX27XH	2.70m	138cm	2	224g	50-100g
SCATEX30M	3.00m	154cm	2	213g	10-30g
SCATEX30MH	3.00m	154cm	2	224g	14-40g
SCATEX30H	3.00m	154cm	2	246g	20-50g
SCATEX30XH	3.00m	154cm	2	273g	50-100g



CATANA EX TELESPIN

- Renewed and improved Full Carbon blank for more sensitivity and stiffness
- Blank matches the casting weights perfectly
- Modern and exciting cosmetics
- New Seaguide reel seat with Vibraspot for good bite and vibration detection
- Versatile range of rods for every type of lure fishing with reduced, convenient transport lengths

SCATEXTE165UL	1.65m	55cm	5	96g	1-11g
SCATEXTE18L	1.80m	64cm	5	120g	3-14g
SCATEXTE21L	2.10m	67cm	5	126g	3-14g
SCATEXTE21ML	2.10m	67cm	5	126g	7-21g
SCATEXTE21M	2.10m	67cm	5	132g	10-30g
SCATEXTE24ML	2.40m	66cm	6	171g	7-21g
SCATEXTE24M	2.40m	66cm	6	173g	10-30g
SCATEXTE24MH	2.40m	66cm	6	184g	14-40g
SCATEXTE27M	2.70m	72cm	6	194g	10-30g
SCATEXTE27MH	2.70m	72cm	6	206g	14-40g
SCATEXTE30M	3.00m	77cm	6	234g	10-30g
SCATEXTE30MH	3.00m	77cm	6	238g	14-40g
SCATEXTE33H	3.30m	85cm	6	274g	20-50g





VENGEANCE CX

- The Composite blank is reliable, strong and offers excellent performance in its price class
- Moderate-fast action produces good casting performance combined with sensitivity in the tip
- SHIMANO Hardlite guides suitable for both braid and mono
- Available with both Cork and EVA handles
- Exceptional rod for the lure fishing beginner or anglers on a small budget



CORK HANDLE

SVCX18LC	1.80m	95cm	2	127g	3-15g
SVCX21MLC	2.10m	111cm	2	158g	3-21g
SVCX21MC	2.10m	111cm	2	179g	10-35g
SVCX24MLC	2.40m	126cm	2	210g	3-21g
SVCX24MC	2.40m	126cm	2	228g	10-35g
SVCX24HC	2.40m	126cm	2	219g	20-50g
SVCX27MLC	2.70m	140cm	2	201g	3-21g
SVCX27MC	2.70m	140cm	2	208g	10-35g
SVCX27HC	2.70m	140cm	2	315g	20-50g
SVCX27XHC	2.70m	140cm	2	361g	50-100g
SVCX30HC	3.00m	155cm	2	286g	15-50g

EVA HANDLE

SVCX18LE	1.80m	95cm	2	123g	3-15g
SVCX21MLE	2.10m	111cm	2	146g	3-21g
SVCX21ME	2.10m	111cm	2	171g	10-35g
SVCX24MLE	2.40m	126cm	2	202g	3-21g
SVCX24ME	2.40m	126cm	2	223g	10-35g
SVCX24HE	2.40m	126cm	2	211g	20-50g
SVCX27MLE	2.70m	140cm	2	196g	3-21g
SVCX27ME	2.70m	140cm	2	202g	10-35g
SVCX27HE	2.70m	140cm	2	316g	20-50g
SVCX27XHE	2.70m	140cm	2	359g	50-100g
SVCX30HE	3.00m	155cm	2	283g	15-50g



FX XT

- SHIMANO's new entry level spinning rod with strong and robust Composite + blank
- Moderate through action helps with casting and offers additional safety when fish-playing
- SHIMANO Hardlite guides suitable for both braid and mono
- EVA handle with secure screw thread DPS reel seat
- Matches perfectly with FX reel making a great combo kit for the inexperienced or young angler



FXXT18L	1.80m	95cm	2	87g	3-14g
FXXT21UL	2.10m	115cm	2	121g	1-11g
FXXT21ML	2.10m	111cm	2	118g	7-21g
FXXT21M	2.10m	111cm	2	116g	10-30g
FXXT21MH	2.10m	111cm	2	123g	14-40g
FXXT24M	2.40m	126cm	2	176g	10-30g
FXXT24MH	2.40m	126cm	2	189g	14-40g
FXXT27M	2.70m	140cm	2	221g	10-30g
FXXT27MH	2.70m	140cm	2	226g	14-40g
FXXT27H	2.70m	140cm	2	240g	20-50g
FXXT27XH	2.70m	140cm	2	256g	50-100g



SUPER SENSITIVE SPINNING RODS



DIAFLASH BX LIGHT

- Hi-Power X construction for reduced blank twist and greater rod strength
- Super sensitive spinning rod for predator fishing with small softbaits, dropshot rigs, spinners, and jigheads for perch and trout
- Blank has enough backbone for ultra-fast hook sets
- Sensitive but strong Taftec Alpha tip for good bite detection
- Lightweight Ci4+ reel seat for perfect fixation of the reel
- Fuji Stainless Steel KR-Type guides

SDFLBX70UL	2.13m	110cm	2	80g	1-7g
SDFLBX74L	2.23m	115cm	2	90g	2-10g
SDFLBX74ML	2.23m	115cm	2	95g	3-15g
SDFLBX80UL	2.44m	125cm	2	90g	1-7g
SDFLBX80ML	2.44m	125cm	2	105g	3-15g



NEW

VENGEANCE CX SENSITIVE

- Strong, low diameter, fast actioned Full Carbon blank with solid tip construction for increased sensitivity
- Specifically designed for smaller predators like perch, trout and chub using small lightweight lures
- SHIMANO Stainless Steel Hardlite guides
- SHIMANO DPS screw down reel seat with integrated in cork front grip
- Modern cork split grip handle finished with durable rubbercork ends to reduce accidental damage
- Exceptional value for money for a specialised rod

SVCX21ULSSC	2.10m	110cm	2	106g	0.5-7g
SVCX21LSSC	2.10m	110cm	2	109g	1-10g
SVCX21MLSSC	2.10m	110cm	2	112g	3-15g
SVCX24MLSSC	2.40m	125cm	2	137g	3-15g
SVCX24MSSC	2.40m	125cm	2	148g	5-20g
SVCX27MLSSC	2.70m	140cm	2	174g	3-15g





TROUT RODS

Trout are one of the most widespread and diverse species in Europe. From natural fish in wild mountain streams, to stocked fish in stillwaters, there are many techniques associated with fishing for trout.

The SHIMANO range of trout rods covers all eventualities, from ultra light Trout Area models to telescopic models designed for stillwater competition anglers.

TROUT NATIVE

140 TROUT NATIVE

TROUT AREA

142 TECHNIUM TROUT AREA

FORCEMASTER TROUT AREA

TROUT POND

143 BEASTMASTER CX TROUT / ZANDER

AERNOS TROUT

144 VENGEANCE AX TROUT / ZANDER

CATANA SHAKING TROUT

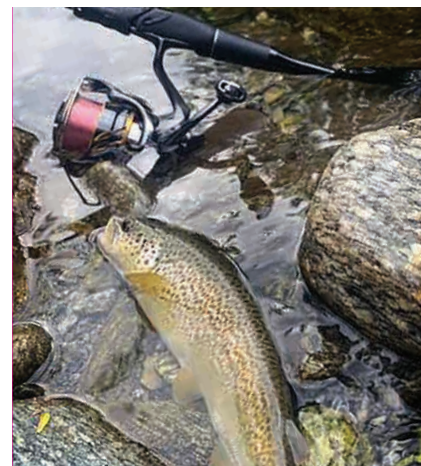
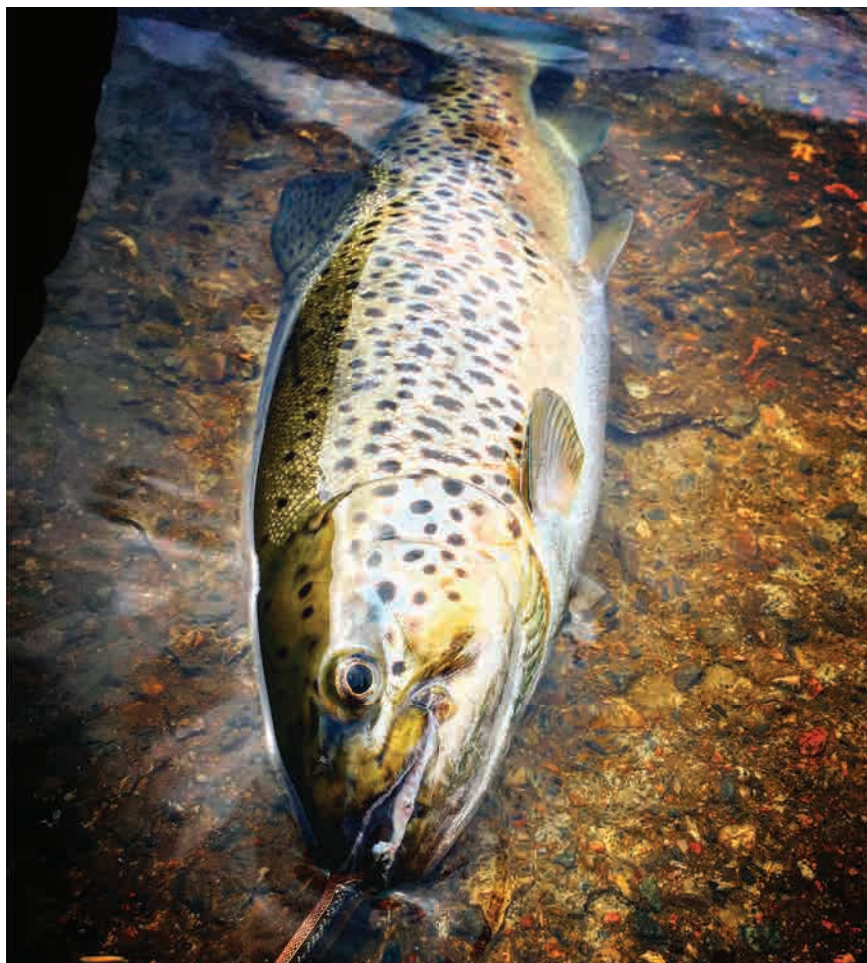

COMPLETE NEW SPECIALIST RANGE



NEW

Trout Native

- Lightweight and sensitive High Modulus Full Carbon + HPC+ Nanosheet blanks with metallic forest green finish
- Special progressive action with fast and moderate fast action tapers
- Fuji Alconite K-Type (80MH and 86H models) or KL-Type long frame guides
- Traditional full cork handle with Seaguide XVS reel seat and metal resonator collar
- Perfect colour and performance match with the Cardiff Ci4+ reel

					
TNSPF66UL	1.98m	102cm	2	96g	1-8g
TNSPMF70ULP	2.13m	109.5cm	2	111g	2-10g
TNSPF70LP	2.13m	109.5cm	2	112g	5-15g
TNSPMF76L	2.28m	117.5cm	2	118g	3-12g
TNSPF76ML	2.28m	117.5cm	2	122g	7-21g
TNSPF80M	2.44m	125cm	2	144g	5-25g
TNSPF80MH	2.44m	125cm	2	152g	15-40g
TNSPMF86MP	2.59m	133cm	2	144g	10-30g
TNSPF86H	2.59m	133cm	2	186g	15-60g



NANOSHEET



**TNSPF66UL**

The ideal rod to fish on small mountain streams or creeks with both micro hardbaits and softbaits. The fast action allows accurate casting and effective twitching of micro jerkbait minnows and softbaits, in addition to classic trout spoons and spinners. The SPECIAL PROGRESSIVE blank curve and the UL power help to keep a constant contact when fighting the fish even with a barbless single hook.

TNSPMF70ULP

With its 213cm, moderate-fast action and UL+ power, this rod is developed to fish with traditional lightweight hardbaits (spinners, spoons or minnows) on streams, creeks or small lakes. The special action makes it also ideal for barbless single hook use.

TNSPF70LP

Versatile 213cm rod developed to fish with both hardbaits and softbaits up to 15g of weight on medium sized streams and rivers. The fast action allows accurate casting and effective twitching of micro jerkbait minnows and softbaits, in addition to classic trout spoons and spinners.

TNSPMF76L

With a 228cm length, moderate-fast action and light power, this model is capable of handling lures up to 12g. Developed to fish with hardbaits in medium sized streams, rivers or lakes. The additional length helps to control light lures at longer distances when compared to a shorter rod. The special progressive moderate-fast taper guarantees excellent control of the fish, even with a barbless single hook.

TNSPF76ML

This 228cm rod is specifically developed to fish on a wide range of venues with the more modern trout lure fishing techniques. The fast action taper is perfect for twitching jerkbait minnows, metal-vib lures and softbaits up to 21g. The strong progressive action has plenty of backbone to control larger trout in stronger currents.

TNSPF80M

A versatile 244cm fast action rod capable of handling hardbaits and softbaits up to 25g in weight. Ideal for fishing medium sized rivers and streams with a moderate current.

TNSPF80MH

A strong, fast tip action with medium-heavy casting power up for lures up to 40g: The 244cm blank has been developed to control heavier twitchbait minnows, softbaits and metal lures in moderate and strong currents.

TNSPMF86MP

With its 259cm length, moderate-fast action and casting power of up to 30g, this is the ideal rod to control medium weight trout hardbaits at distance. Perfect for wide lowland rivers and lakes. Excellent lipless minnow and spoon rod, the special progressive curve ensures good casting performance and optimal fish-playing.

TNSPF86H

Specifically developed to cast and handle the heaviest lures, in the strongest currents. The powerful fast action blank is fitted with a 30mm Fuji K-series starter guide and has a 60g lure rating. The perfect rod for trophy sized trout throughout Europe.



TECHNIUM TROUT AREA

- Ultra thin High Modulus Full Carbon blank which is highly responsive and designed for casting lightweight lures as small as 0.5g
- Fuji Alconite KR-Type guides for thin braid and light mono lines
- High quality cork handle
- Perfect Ultra Light/Slow action for casting ultralight spoons and cranks and assured fish-playing

STECTA185SUL	1.85m	95.5cm	2	70	0.5-3g
STECTA185UL	1.85m	95.5cm	2	72	1.5-4.5g
STECTAC185UL	1.85m	95.5cm	2	72	1.5-3.5g
STECTA195SUL	1.95m	100.5cm	2	73	0.5-3g
STECTA195UL	1.95m	100.5cm	2	73	1.5-4.5g

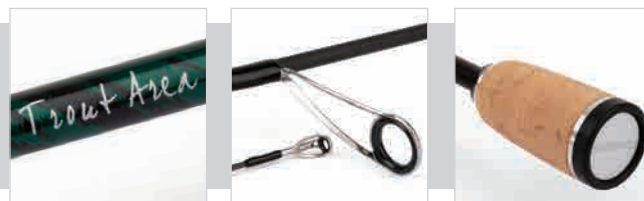

Force Master TROUT AREA

- Slim, Full Carbon blank with parabolic action
- Well balanced rod with Pac Bay reel seat
- Ergonomic EVA Split grip
- Made for fishing with small spoons, roll swimmers and small cranks
- Entry level for trout area fishing

SFMTA185SUL	1.85m	96cm	2	72g	0.5-3.5g
SFMTA185UL	1.85m	96cm	2	76g	1.5-5g
SFMTA195SUL	1.95m	101cm	2	77g	0.5-3.5g
SFMTA195UL	1.95m	101cm	2	79g	1.5-5g





BeastMaster CX TROUT / ZANDER

- Full Carbon + HPC+ Biofibre blank in 3 section design
- SHIMANO Stainless Steel Hardlite guides
- Custom designed reel seat and cork handle

BMCXTRZ300	3.00m	105cm	3	194g	5-40g
BMCXTRZ330	3.30m	115cm	3	195g	5-40g
BMCXTRZ360	3.60m	125cm	3	233g	5-40g

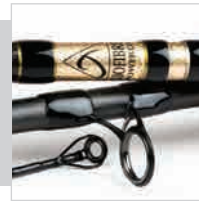

AERNOS TR GT LITE POWER / HI POWER

- Full Carbon blank
- Telescopic trout rod especially designed for modern trout fishing techniques like tremarella technique
- Rods are numbered 0-9, easy to recognize and suitable for trout match fishing
- Lite Power (0 – 4) and Hi Power (5 – 9) models available
- Small and light Pac Bay Minima 4 guides and Pac Bay reel seat
- Cloth bag with plastic guide protector

ARNRLITGT039	3.90m	129cm	7	127g	0-3g
ARNRLITGT139	3.90m	129cm	7	147g	1-4g
ARNRLITGT239	3.90m	129cm	7	150g	2-5g
ARNRLITGT339	3.90m	129cm	7	156g	3-8g
ARNRLITGT441	4.10m	129cm	7	172g	5-10g
ARNRHTGT542	4.20m	129cm	7	171g	8-12g
ARNRHTGT642	4.20m	129cm	7	189g	10-18g
ARNRHTGT745	4.50m	129cm	7	201g	15-20g
ARNRHTGT845	4.50m	129cm	7	220g	20-30g
ARNRHTGT945	4.50m	129cm	7	220g	25-40g





VENGANCE AX TROUT / ZANDER





- Composite blank with a sensitive, fast tip action
- Multi purpose rod for both zander and trout fishing
- Slim IPSA-type reel seat
- Cork handle

					
VAXTR300	3.00m	105cm	3	185g	5-40g
VAXTR330	3.30m	114cm	3	206g	5-40g
VAXTR360	3.60m	125cm	3	231g	5-40g



CATANA SHAKING TROUT

- Full Carbon+ Geofibre blank designed for 'shaking trout' methods
- SHIMANO Stainless Steel Hardlite guides
- SHIMANO design reel seat

					
CATSHTR127	2.70m	139cm	2	109g	1-3g
CATSHTR227	2.70m	139cm	2	120g	2-5g



GEOFIBRE



146	BEASTMASTER TELE BEASTMASTER CATFISH STATIC
147	BEASTMASTER CATFISH FIREBALL BEASTMASTER CATFISH LURE
148	FORCEMASTER CATFISH STATIC FORCEMASTER CATFISH LURE FORCEMASTER CATFISH FIREBALL

CATFISH RODS

Within the catfish range there are four BEASTMASTER models that use tough HPC carbon with added Biofibre for amazing lightness and strength. All are fitted with ultra strong guides to cope with braid or mono lines.

For occasional catfish anglers, the FORCEMASTER Catfish offers great value and is available in three models to suit your preference.

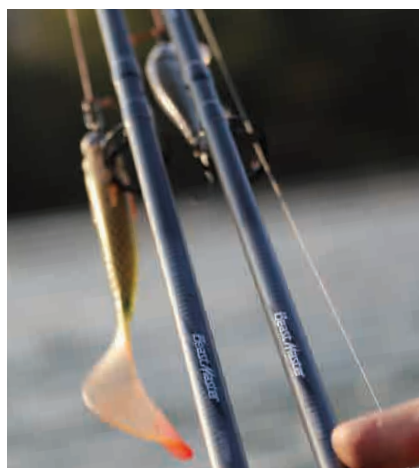
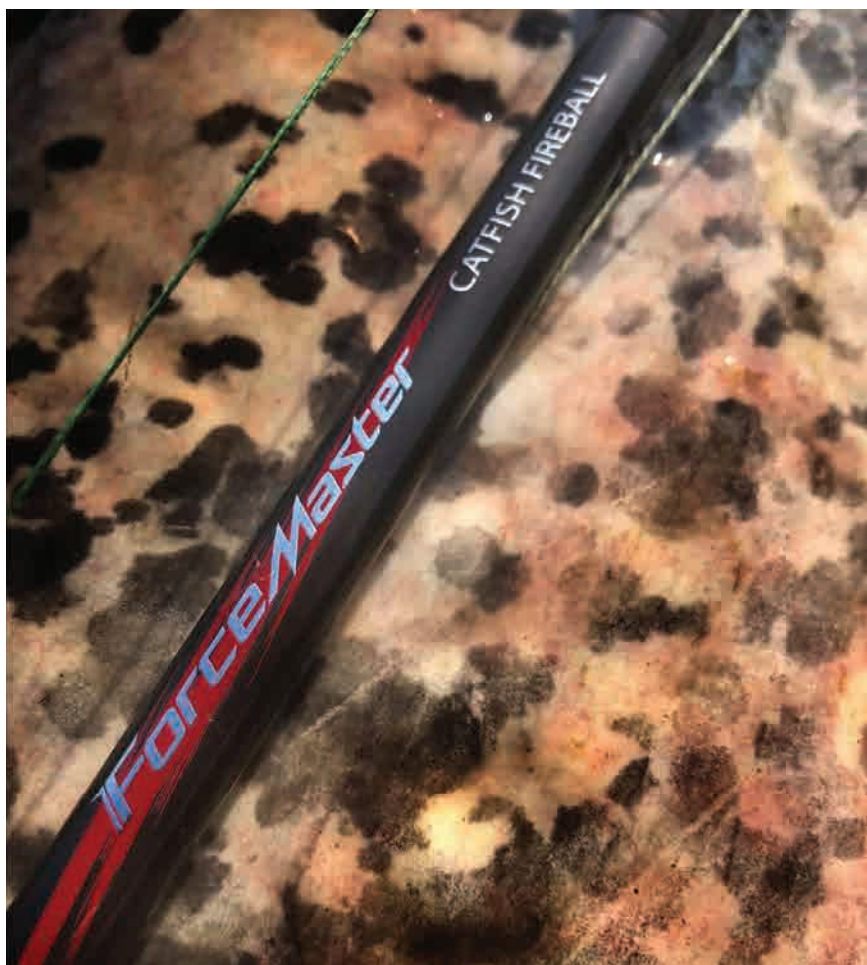



Beast Master TELESCOPIC

- Full Carbon + HPC + Biofibre blank
- Ideal rod for catching catfish and sturgeon
- Convenient transport length
- Can be perfectly used in ponds and rivers
- Adjustable reel seat for preferred positioning
- Cloth bag

SBMCSTE4220



4.20m



165cm



4



546g



200g



Beast Master CATFISH STATIC

- Full Carbon + HPC + Biofibre blank
- Ideal for static fishing from the bank using e.g. buoy system or for fishing with pellets
- Two models for catching small to very big catfish
- Cloth bag

SBMCFST30300



3.00m



154cm



2



394g



300g

SBMCFST32500

3.20m

164cm

2

428g

450g





Beast Master CATFISH FIREBALL

- Full Carbon + HPC + Biofibre blank
- Perfect rod for using fireball system or vertical jigging with soft baits
- Due to short length ideal for fishing from boat or belly boat
- Casting version available
- Cloth bag

SBMCFB18320	1.83m	183cm	1	250g	85-200g
SBMCFB18342	1.83m	183cm	1	238g	160-420g
CBMCFB18320	1.83m	183cm	1	235g	85-200g
SBMCFB21XT	2.10m	141cm	2	377g	500g



Beast Master CATFISH LURE

- Full Carbon + HPC + Biofibre blank
- Designed for using all kind of lures but also float fishing is possible
- Good casting abilities
- Cloth bag

SBMCF24200	2.40m	124cm	2	259g	200g
SBMCF27200	2.70m	138cm	2	293g	200g





Force Master CATFISH STATIC

- Extra strong Full Carbon blanks, capable of fighting big and strong catfish
- Strong DPS reel seat and EVA handle for secure grip
- SHIMANO Hardlite guides
- Rubber bulb butt finish to make fish-playing more comfortable
- Long lengths for bank fishing with buoy, underwater float (with baitfish or worms) and pellets

SFMCFB130500
SFMCFB133500

Length	Blank Length	Reel Seats	Weight	Load
3.00m	155cm	2	472g	500g
3.30m	170cm	2	475g	500g



Force Master CATFISH LURE

- Extra strong Full Carbon blanks, capable of fighting big and strong catfish
- Strong DPS reel seat and EVA handle for secure grip
- SHIMANO Hardlite guides
- Rubber bulb butt finish to make fish-playing more comfortable
- Extra strong spinning rods for fishing lures and floats from a boat or the bank

SFMC24200
SFMC27200

Length	Blank Length	Reel Seats	Weight	Load
2.40m	125cm	2	320g	160g
2.70m	140cm	2	330g	160g



Force Master CATFISH FIREBALL

- Extra strong Full Carbon blanks, capable of fighting big and strong catfish
- Strong DPS reel seat and EVA handle for secure grip
- SHIMANO Hardlite guides
- Rubber bulb butt finish to make fish-playing more comfortable
- Very strong, powerful rods for fishing from a boat with teaser (worms) or fireball (baitfish) techniques

SFMCFFB18320
SFMCFFBC18320

Length	Blank Length	Reel Seats	Weight	Load
1.83m	183cm	1	262g	85-200g
1.83m	183cm	1	250g	85-200g

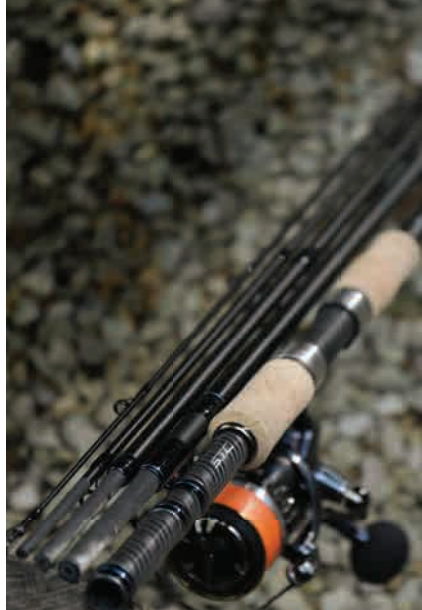

S.T.C. RODS

The range of SHIMANO Travel Concept (S.T.C.) rods has been designed to offer ease of transport with exceptional performance.

Covering a wide range of fishing styles, the S.T.C. rods are not only perfect for long haul travel by air, they are perfect for anglers who want a day-to-day easy transport solution for cars, bikes, and public transport.

All of the S.T.C. rods come with a protective transport case that enables the rod to be transported with the reel in place.

150	S.T.C. SPINNING
	S.T.C. MULTI SPIN
151	S.T.C. MONSTER
	S.T.C. MINI TELESPIN
	S.T.C. DUAL TIP
152	S.T.C. SHORE BOAT
	S.T.C. POWERGAME
153	S.T.C. SURF
154	S.T.C. BOAT





STC SPINNING

- Full Carbon + Nanosheet blank produces a fast action ideal for a wide range of spinning styles
- SHIMANO custom designed DPS reel seat with high quality abbreviated cork handle
- Single leg SHIMANO Hardlite guides

STCSPIN24M	2.40m	64cm	4	128g	10-30g
STCSPIN24H	2.40m	64cm	4	142g	20-60g
STCSPIN24XH	2.40m	64cm	4	153g	50-100g
STCSPIN27MH	2.70m	58cm	5	184g	15-40g
STCSPIN27H	2.70m	58cm	5	196g	20-60g
STCSPIN27XH	2.70m	58cm	5	216g	50-100g
STCSPIN30H	3.00m	65cm	5	229g	20-60g

NANOSHEET



STC MULTI SPIN

- Full Carbon + Nanosheet blank produces a fast action ideal for a wide range of spinning styles
- Multi-length design for increased versatility
- SHIMANO custom designed DPS reel seat with high quality abbreviated cork handle
- Single leg SHIMANO Hardlite guides

STCSPIN2124L	2.10/2.40m	53cm	6	115/123g	3-14g
STCSPIN2124M	2.10/2.40m	53cm	6	129/142g	10-30g
STCSPIN2427L	2.40/2.70m	60cm	6	131/146g	3-14g
STCSPIN2427MH	2.40/2.70m	60cm	6	159/178g	15-40g
STCSPIN2730ML	2.70/3.00m	65cm	6	152/179g	5-25g
STCSPIN2730H	2.70/3.00m	65cm	6	183/207g	20-60g
STCSPIN2730XH	2.70/3.00m	65cm	6	192/221g	50-100g

NANOSHEET





STC MONSTER

- Full Carbon + HPC blank with a moderately fast action
- Imense power and strength ideal for saltwater big game fish
- SHIMANO custom designed DPS reel seat with EVA handle
- Double leg SHIMANO Hardlite guides for extra strength



STCM024
STCM0315

2.40m	66cm	4	271g	28-110g
3.15m	69cm	5	323g	28-110g



STC MINI TELESPIN

- Full Carbon blank produces a versatile moderately fast action
- Remarkable short pack length for very easy transport
- SHIMANO custom designed DPS reel seat with high quality cork handle
- Single leg SHIMANO Hardlite guides



STCMTS18L
STCMTS18ML
STCMTS21ML
STCMTS21M
STCMTS24L
STCMTS24M
STCMTS27ML
STCMTS27M

1.80m	30cm	10	82g	3-14g
1.80m	30cm	10	85g	7-21g
2.10m	35cm	10	98g	7-21g
2.10m	35cm	10	103g	10-30g
2.40m	40cm	11	126g	3-14g
2.40m	40cm	11	128g	10-30g
2.70m	40cm	11	150g	7-21g
2.70m	40cm	11	152g	10-30g



STC DUAL TIP

- High Modulus Full Carbon blank + Nanosheet blank produces an extra fast action
- Twin Tip design offers unbeatable versatility of action
- Fuji DPS reel seat with cork handle
- Single leg SHIMANO Hardlite guides



STCDTMLMH2521
STCDTHXH2521

2.50/210m	57cm	5 (2 tips)	143/149g	7-21/14-40g
2.50/210m	57cm	5 (2 tips)	168/176g	20-50/50-100g



STC SHORE BOAT

- Full Carbon + Nanosheet + Biofibre blank with extra fast action
- Immense power and strength ideal for saltwater big game fish
- Fuji DPS reel seat with EVA handle
- Double leg SHIMANO Hardlite guides for extra strength
- Multi-length design for increased versatility, can be used from a boat (2.40m) or the shore (3.00m)

STCDTSHB03024



3.00/2.40m



65cm



5 (2 tips)



288/308g



28-122/150-300g

NANOSHEET

BIOFIBRE

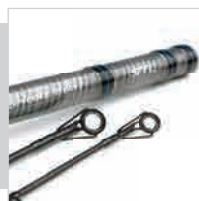

STC POWERGAME

- Full Carbon + Nanosheet + Biofibre blank with extra fast action
- Immense power and strength ideal for saltwater big game fish
- Fuji DPS reel seat with EVA handle
- Double leg SHIMANO Hardlite guides for extra strength
- Multi-length design for increased versatility, the shorter length (2.00m) is a powerhouse for deep water boat fishing, the longer length (2.40m) makes an excellent rod for casting large lures

STCDTPOB02520



2.40/2.00m



55cm



5 (2 tips)



216/227g



40-120/150-300g

NANOSHEET

BIOFIBRE

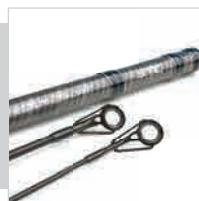





6 PART TRAVEL ROD



S.T.C. SURF

- High Modulus Full Carbon + Nanosheet blank offering immense power and strength ideal for long range surfcasting
- Six section design for easy transport
- Special shrink tube handle with cross grip tape for extra sure handling
- SHIMANO DPS reel seat (425 BX-H) for surf casting/ big pit reels and SHIMANO Slide 'n Grip adjustable reel seat (130M) for multiplier reels
- Seaguide guides for extra strength
- Supplied with strong travel tube for international travel

NANOSHEET

					
STCSF425BXH	4.25m	76cm	6	686g	225g
STCSF130M	3.96m	71cm	6	775g	225g







ROBUST TRAVEL ROD

STC BOAT

- Very strong, fast actioned High Modulus Full Carbon + Nanosheet blank with slim profile designed for saltwater boat spinning methods
- Ideal for a wide range of styles including regular jigging (softbaits, metal jigs, pilk), casting with lures (stickbaits and poppers), light game (trolling with medium sized lures)
- Strong saltwater proof Seaguide Black HERO guides
- Full EVA handle with SHIMANO DPS reel seat

HANDSHEET

					
STCBT2030	2.18m	63.5cm	4	486g	20-30lb
STCBT3050	2.18m	63.5cm	4	489g	30-50lb
STCBT240200	2.40m	68cm	4	245g	100-200g
STCBT240300	2.40m	68cm	4	259g	150-300g





SPECIMEN RODS

SHIMANO specimen rods cover a wide variety of budgets and requirements. Within the TRIBAL rod range there is something for every carp angler. Whether you're looking to cast huge distances with ease, mid-range with pinpoint accuracy or at close range with stealth, you'll find a TRIBAL TX rod to suit your style and budget.

158	TRIBAL TX ULTRA
	TRIBAL TX-9
159	TRIBAL TX-7
	TRIBAL TX-5
160	TRIBAL TX-4
	TRIBAL TX-2
161	TRIBAL TX-1A
162	TRIBAL TX INTENSITY
163	TRIBAL TX-A SPOD & MARKER
	TRIBAL TX FLOATER
MULTI PIECE	
164	TRIBAL TX LITE A
	TRIBAL TX-1 LITE



TRIBAL TX FEATURES

INTENSITY PERFORMANCE

All TRIBAL TX models feature Intensity actions in addition to the normal range of test curves.

Intensity models have been developed for maximum casting performance and use a range of different carbon blends (depending on price) and advanced tapers, to harness the power of the cast. The handles are also longer (70cm) than standard rods of the same length, to help generate more tip speed during the cast.

Intensity rods have been designed for maximum casting performance using a 3oz (85g) to 5oz (142g) lead, with the optimum weight being 4.5oz (128g).



THE INTENSITY ACTIONS OF THE DIFFERENT TX ROD RANGES VARY DEPENDING ON MODEL TYPE. BELOW IS A GUIDE TO THE CASTING AND FISH-PLAYING PERFORMANCE YOU CAN EXPECT FROM EACH MODEL RATED OUT OF 5 FOR EACH CATEGORY.

TX-ULTRA

The TX Ultra is built using SHIMANO's very best carbon technology. This produces the ultimate in casting rod performance combined with exceptional fish-playing performance.

Casting performance - 5
Fish-playing - 5

TX-9

The TX-9 is potentially a world beater when it comes to distance performance. Slightly more power than the Ultra whilst retaining a very acceptable fish-playing action.

Casting performance - 5
Fish-playing - 4

TX-7

TX-7 holds a casting world record for an 'off-the-shelf' carp rod. Immensely powerful, this powerhouse of a rod does sacrifice a bit of playing action to get the immense distance.

Casting performance - 5
Fish-playing - 3

TX-5

TX-5 is a fantastic all round casting rod which combines distance potential with a pleasing fish-playing action.

Casting performance - 3
Fish-playing - 4

TX-4

TX-4 is an animal and rated by some as the best distance/cost ratio available. The playing action isn't the most sophisticated, but if you want to hit the horizon, this could be the model for you.

Casting performance - 5
Fish-playing - 2

TX-2

TX-2 offers outstanding value for money and is SHIMANO's largest selling carp rod. The Intensity version delivers great distance and has a surprisingly pleasing playing action. For the money you won't get better.

Casting performance - 4
Fish-playing - 3

TEST CURVES - LENGTHS, STRENGTHS & PERFORMANCE

The figures in the table are for a TRIBAL TX 2 rod and are actual distances measured by Mike Dagnall (one of the UK's longest casters), using a Big Pit 14000 reel with a 50lb shockleader, tied to 0.30mm (10lb) Aero Carp mono and no rig.

You can see from the results how the test curve rating (and length) relates to the maximum performance for each given lead weight, with the 'sweet spot' for maximum distance being between 3oz (85g) to 4oz (113g).

Look out for the test curve charts throughout the rest of the TRIBAL range.

TX-2 TEST CURVE	CASTING WEIGHT						
	2oz 57g	2.5oz 71g	3oz 85g	3.5oz 99g	4oz 113g	4.5oz 128g	5oz 142g
13ft INT	167yds	172yds	189yds	212yds	210yds	200yds	196yds
13ft 300lb	172yds	178yds	203yds	200yds	192yds	185yds	170yds
12ft 325lb	162yds	169yds	176yds	189yds	187yds	178yds	156yds
12ft 300lb	155yds	163yds	168yds	163yds	156yds	149yds	DNC
12ft 275lb	139yds	145yds	156yds	149yds	142yds	DNC	DNC

REEL SEATS & HANDLES

SHIMANO carp rod reel seats are designed and selected to perform to the maximum efficiency, whilst retaining an aesthetically pleasing profile. Handles come in varying styles and include abbreviated EVA, slim shrink tube, Winn Gripp and traditional cork (TX-2) options.



Ci4+ REEL SEAT

Ultra lightweight custom designed reel seat. Available on the TX-Ultra and TX-9 models.



FUJI REEL SEAT

Recognised as a market leader, Fuji DPS reel seats are used on the TX-7 and TX-5 models.



SHIMANO REEL SEAT

The highly attractive SHIMANO woven carbon reel seat is used on the TX-4 with a plain version used on the TX-2.

GUIDES

The use of quality guides on a carp rod is very important for reducing line friction when casting and preventing tangles. SHIMANO carp rods feature specialist Fuji, Kigan or Seaguide guides. The use of 50mm but rings on longer casting rods is widespread and anti-tangle tip guides are a common feature throughout the range.

FUJI

Fuji 'K' Guides with SiC linings are used on the TX-Ultra models. (12ft 2.75lb & 12ft 3.00lb).



KIGAN 3D

Kigan 3D guides are lightweight, strong and have zirconia linings. They can be found on the TX-Ultra (12ft INT & 13ft INT), TX-9 and TX-7 models.



SEAGUIDE

Seaguide guides offer reliable, friction reducing performance and can be found on the TX-5, TX-4 and TX-2 models.





TRIBAL TX-ULTRA

- The flagship series in the TRIBAL family
- Blank construction uses Spiral X and Hi-Power X for outstanding casting performance
- Ci4+ reel seat
- Slim and lightweight blank
- Spiral X to eliminate blank twist and deliver supreme accuracy
- EVA split grip ideal for placing rod locked in your backrest
- Intensity models (INT) offer ground breaking casting performance



TXUL12275	40mm	3.66m	188cm	2	310g	2.75lb
TXUL12300	40mm	3.66m	188cm	2	360g	3.00lb
TXUL121INT	50mm	3.66m	188cm	2	390g	3.50lb+
TXUL131INT	50mm	3.96m	203cm	2	435g	3.50lb+

REEL: ULTEGRA Ci4 14000 XTC
LINE: 0.31mm
LEADER: Mono
DISTANCE: Maximum performance for each given weight, measured in Yards

TX ULTRA TEST CURVE	CASTING WEIGHT						
	2oz 57g	2.5oz 71g	3oz 85g	3.5oz 99g	4oz 113g	4.5oz 128g	5oz 142g
13ft INT	168yds	177yds	190yds	206yds	215yds	217yds	195yds
12ft INT	162yds	169yds	185yds	195yds	204yds	205yds	191yds
12ft 325lb	162yds	169yds	171yds	186yds	171yds	163yds	DNC
12ft 300lb	147yds	151yds	164yds	173yds	149yds	137yds	DNC



TRIBAL TX-9A

- Unique Spiral X blank produces immense power and extremely accurate distance casting
- Kigan 3D Zirconia guides
- Ultra lightweight SHIMANO Ci4+ carbon reel seat
- High density EVA handle
- Intensity models (INT) offer ground breaking casting performance and powerful playing action
- SPC model has cork handle



TX9A10300	30mm	3.05m	152cm	2	255g	3lb
TX9A12275	40mm	3.66m	188cm	2	337g	2.75lb
TX9A12300	50mm	3.66m	188cm	2	280g	3lb
TX9A12300SPC	50mm	3.66m	188cm	2	337g	3lb
TX9A12325	50mm	3.66m	188cm	2	355g	3.25lb
TX9A121INT	50mm	3.66m	188cm	2	382g	3.5lb+
TX9A131INT	50mm	3.96m	203cm	2	425g	3.5lb+

REEL: ULTEGRA Ci4 14000 XTC
LINE: 0.31mm
LEADER: Mono
DISTANCE: Maximum performance for each given weight, measured in Yards

TX-9 TEST CURVE	CASTING WEIGHT						
	2oz 57g	2.5oz 71g	3oz 85g	3.5oz 99g	4oz 113g	4.5oz 128g	5oz 142g
13ft INT	155yds	168yds	180yds	209yds	214yds	215yds	199yds
12ft INT	143yds	154yds	168yds	179yds	200yds	190yds	155yds
12ft 325lb	162yds	173yds	174yds	186yds	174yds	168yds	DNC
12ft 300lb	152yds	154yds	158yds	176yds	155yds	145yds	DNC
12ft 275lb	157yds	162yds	169yds	162yds	149yds	DNC	DNC
10ft 300lb	132yds	155yds	168yds	152yds	146yds	DNC	DNC





TRIBAL TX-7

- High Modulus Full Carbon + HPC blank enforced with Biofibre
- Kigan Stainless Steel Zirconia guides
- Fuji DPS reel seat
- Thin EVA rear grip
- All models come with a 50mm starter guide
- The 13ft INIT holds World Record in 4oz/114g at 247yds in overhead casting category



TX712275	50mm	3.66m	187cm	2	325g	2.75lb
TX712300	50mm	3.66m	187cm	2	326g	3.00lb
TX712325	50mm	3.66m	187cm	2	373g	3.25lb
TX712INT	50mm	3.66m	187cm	2	399g	3.50lb+
TX713INT	50mm	3.96m	202cm	2	427g	3.50lb+

REEL: ULTEGRA Ci4 14000 XTC
LINE: 0.31mm
LEADER: Mono
DISTANCE: Maximum performance for each given weight, measured in Yards

TX-7 TEST CURVE	CASTING WEIGHT						
	2oz 57g	2.5oz 71g	3oz 85g	3.5oz 99g	4oz 113g	4.5oz 128g	5oz 142g
13ft INT	162yds	172yds	184yds	209yds	218yds	219yds	202yds
12ft INT	155yds	172yds	189yds	199yds	204yds	195yds	166yds
12ft 325lb	160yds	169yds	173yds	187yds	171yds	165yds	DNC
12ft 300lb	150yds	154yds	157yds	174yds	158yds	148yds	DNC
12ft 275lb	155yds	160yds	164yds	168yds	146yds	DNC	DNC



TRIBAL TX-5

- Full Carbon + HPC + Biofibre
- Seaguide SIC guides (50mm starter guide)
- Fuji DPS reel seat
- Slim rear grip with wrapped tape
- Safety rod stopper on handle and protective line clip
- Intensity models (INT) offer ground breaking casting performance



TX512275	50mm	3.66m	187cm	2	283g	2.75lb
TX512300	50mm	3.66m	187cm	2	324g	3.00lb
TX512325	50mm	3.66m	187cm	2	327g	3.25lb
TX512INT	50mm	3.66m	187cm	2	387g	3.50lb+
TX513INT	50mm	3.96m	202cm	2	394g	3.50lb+

REEL: ULTEGRA Ci4 14000 XTC
LINE: 0.31mm
LEADER: Mono
DISTANCE: Maximum performance for each given weight, measured in Yards

TX-5 TEST CURVE	CASTING WEIGHT						
	2oz 57g	2.5oz 71g	3oz 85g	3.5oz 99g	4oz 113g	4.5oz 128g	5oz 142g
13ft INT	155yds	170yds	190yds	202yds	209yds	201yds	193yds
12ft INT	138yds	154yds	167yds	177yds	195yds	180yds	172yds
12ft 325lb	152yds	168yds	181yds	187yds	179yds	167yds	DNC
12ft 300lb	148yds	152yds	160yds	165yds	158yds	DNC	DNC
12ft 275lb	150yds	160yds	164yds	156yds	DNC	DNC	DNC





TRIBAL TX-4

- Range now extended with models ranging from 9' length 3.0lb for stalking and 10' length for boat and short range fishing, through to 13' length Intensity for long range casting
- A powerful Full Carbon + HPC + Biofibre blank
- Seaguide Stainless Steel SIC guides
- SHIMANO Woven Carbon DPS with small front EVA grip
- Slim shrink grip handle with in-built rest stopper



REEL: ULTEGRA Ci4 14000 XTC
LINE: 0.31mm
LEADER: Mono
DISTANCE: Maximum performance for each given weight, measured in Yards

TX49300 STALKER	40mm	2.74m	141cm	2	217g	3.00lb
TX410275	40mm	3.05m	156cm	2	243g	2.75lb
TX410300	40mm	3.05m	156cm	2	257g	3.00lb
TX410325	40mm	3.05m	156cm	2	270g	3.25lb
TX412275	50mm	3.66m	187cm	2	299g	2.75lb
TX412300	50mm	3.66m	187cm	2	341g	3.00lb
TX412325	50mm	3.66m	187cm	2	369g	3.25lb
TX412INT	50mm	3.66m	187cm	2	409g	3.50lb+
TX413INT	50mm	3.96m	202cm	2	460g	3.50lb+

TX-4 TEST CURVE	CASTING WEIGHT						
	2oz 57g	2.5oz 71g	3oz 85g	3.5oz 99g	4oz 113g	4.5oz 128g	5oz 142g
13ft INT	145yds	167yds	174yds	195yds	211yds	210yds	202yds
12ft INT	162yds	175yds	190yds	199yds	203yds	197yds	170yds
12ft 325lb	141yds	159yds	170yds	181yds	172yds	152yds	DNC
12ft 300lb	142yds	147yds	158yds	160yds	160yds	145yds	DNC
12ft 275lb	142yds	144yds	153yds	144yds	DNC	DNC	DNC
10ft 325lb	154yds	162yds	169yds	169yds	159yds	143yds	DNC
10ft 300lb	128yds	148yds	165yds	152yds	153yds	DNC	DNC
10ft 275lb	134yds	146yds	158yds	142yds	DNC	DNC	DNC
9ft 300lb	140yds	150yds	141yds	DNC	DNC	DNC	DNC



TRIBAL TX-2

- High Modulus Full Carbon blank with slim profile and progressive action for excellent casting performance
- Seaguide SIC guides (50mm starter guide on longer models)
- SHIMANO DPS reel seat
- Slim shrink tube or cork handle options
- Application models for stalking and floater fishing
- SHIMANO's best selling carp rod in 2018
- Floater model available with cork handle (page 163)



CORK HANDLE

TX210300SPC	40mm	3.05m	157cm	2	328g	3.00lb
TX212275SPC	50mm	3.66m	187cm	2	350g	2.75lb
TX212300SPC	50mm	3.66m	187cm	2	371g	3.00lb
TX212325SPC	50mm	3.66m	187cm	2	433g	3.25lb
TX213INTSPC	50mm	3.96m	202cm	2	470g	3.50lb+

REEL: ULTEGRA Ci4 14000 XTC
LINE: 0.31mm
LEADER: Mono
DISTANCE: Maximum performance for each given weight, measured in Yards

SHRINK TUBE HANDLE

TX29300 STALKER	30mm	2.74m	141cm	2	236g	3.00lb
TX210275	30mm	3.05m	157cm	2	276g	2.75lb
TX210300	40mm	3.05m	157cm	2	317g	3.00lb
TX211275	40mm	3.35m	167cm	2	321g	2.75lb
TX212275	50mm	3.65m	187cm	2	338g	2.75lb
TX212300	50mm	3.65m	187cm	2	363g	3.00lb
TX212325	50mm	3.65m	187cm	2	434g	3.25lb
TX213300	50mm	3.96m	202cm	2	441g	3.00lb
TX213INT	50mm	3.96m	202cm	2	445g	3.50lb+

TX-2 TEST CURVE	CASTING WEIGHT						
	2oz 57g	2.5oz 71g	3oz 85g	3.5oz 99g	4oz 113g	4.5oz 128g	5oz 142g
13ft INT	167yds	172yds	189yds	212yds	210yds	200yds	196yds
13ft 300lb	172yds	178yds	203yds	200yds	192yds	185yds	170yds
12ft 325lb	162yds	169yds	176yds	189yds	187yds	178yds	156yds
12ft 300lb	155yds	163yds	168yds	163yds	156yds	149yds	DNC
12ft 275lb	139yds	145yds	156yds	149yds	142yds	DNC	DNC
11ft 275lb	130yds	135yds	142yds	140yds	130yds	DNC	DNC
10ft 300lb	129yds	139yds	155yds	138yds	DNC	DNC	DNC
9ft 300lb	135yds	143yds	140yds	DNC	DNC	DNC	DNC

GREAT CASTING



TRIBAL TX-1A

- Responsive Full Carbon blank offers excellent performance to price ratio for the budget conscious angler
- Seaguide SIC guides (50mm starter guide on longer models)
- SHIMANO DPS reel seat
- Slim shrink EVA or cork handle options
- Full range available from 9' length 3.0lb for stalking and 10' length for boat and short range fishing, through to 13' length Intensity for long range casting

TX1A9300 STALKER	30mm	2.74m	142cm	2	250g	3.00lb
TX1A10300	40mm	3.05m	158cm	2	310g	3.00lb
TX1A12275	40mm	3.66m	188cm	2	382g	2.75lb
TX1A12300	50mm	3.66m	188cm	2	424g	3.00lb
TX1A12325	50mm	3.66m	188cm	2	395g	3.25lb
TX1A12INT	50mm	3.66m	188cm	2	422g	3.50lb+
TX1A13INT	50mm	3.96m	203cm	2	480g	3.50lb+
TX1A113003	40mm	3.35m	116cm	3	366g	3.00lb
TX1A123003	50mm	3.66m	127cm	3	413g	3.00lb
TX1A12INT3	50mm	3.66m	127cm	3	430g	3.50lb+
TX1A13INT3	50mm	3.96m	137cm	3	470g	3.50lb+
CORK HANDLE						
TX1A12300SPC	50mm	3.61m	191cm	2	406g	3.00lb
TX1A12325SPC	50mm	3.61m	191cm	2	355g	3.25lb
TX1A13INTSPC	50mm	3.91m	207cm	2	455g	3.50lb+









SPOD & MARKER



TRIBAL TX-INTENSITY SPOD & MARKER

- Exclusive Spiral X Core blank construction removes blank twist and ovalisation for extremely powerful, accurate casting
- Futuristic design compliments TX-ULTRA and TX-9 rods
- SHIMANO Ci4+ reel seat
- High quality Double leg Kigan 3D Zirconia guides throughout
- EVA split grip
- 5.0lb test curve will cope with the largest spods
- Distances achieved with baiting device of 206yds (12ft) and 218yds (13ft) in testing



						
TXINTSPODMRK12	50mm	3.66m	188cm	2	344g	5.00lb
TXINTSPODMRK13	50mm	3.96m	203cm	2	412g	5.00lb





Spod

TRIBAL TX-A SPOD & MARKER

- Full Carbon blank is stiff, powerful and responsive - the ideal action to cast extreme distances with spods, spombs and marker floats
- Spod models have 5lb test curve for casting heavy spods, Marker models have 3lb test curve for long range marker float casting
- Seaguide Stainless SIC guides (50mm starter guide)
- SHIMANO DPS reel seat
- Slim shrink handle with EVA front grip

SPOD

TXAS12500

TXAS13500

MARKER

TXAM12300



50mm	3.66m	188cm	2	502g	5.00lb
50mm	3.96m	203cm	2	558g	5.00lb
50mm	3.96m	188cm	2	528g	3.00lb



TX-2

TRIBAL FLOATER

- High Modulus Full Carbon blank with slim profile and progressive action for excellent casting performance
- SHIMANO DPS reel seat
- Slim shrink EVA handle

TX2FL12200

30mm	3.66m	187cm	2	278g	2.00lb
------	-------	-------	---	------	--------





TRIBAL TX-LITE

- High Modulus Full Carbon blank with Nanosheet technology produces well balanced, lightweight feel with progressive power action
- Short length 4 piece design for easy transport but retains performance characteristics of a conventional 2 piece rod
- Seaguide Stainless SIC guides
- Exclusive SHIMANO drilled woven carbon reel seat
- Full range available from 9' length 3.0lb for stalking and 10' length for boat and short range fishing, through to 12' length Intensity for long range casting

NANOSHEET



TXLA9300	30mm	2.74m	73.5cm	4	206	3.00lb
TXLA10275	40mm	3.05m	80.5cm	4	276	2.75lb
TXLA10300	40mm	3.05m	80.5cm	4	291	3.00lb
TXLA1010INT	40mm	3.05m	80.5cm	4	301	3.50lb+
TXLA12300	50mm	3.66m	96.5cm	4	376	3.00lb
TXLA1210INT	50mm	3.66m	96.5cm	4	400	3.50lb+
TXLA78300	-	2.13/2.44m	58.5cm	4+EXT	189	3.00lb

REEL: ULTEGRA Ci4 14000 XTC
LINE: 0.31mm
LEADER: Mono
DISTANCE: Maximum performance for each given weight, measured in Yards

TX-LITE TEST CURVE	CASTING WEIGHT						
	2oz 57g	2.5oz 71g	3oz 85g	3.5oz 99g	4oz 113g	4.5oz 128g	5oz 143g
12ft INT	142yds	147yds	152yds	155yds	169yds	155yds	142yds
12ft 300lb	141yds	149yds	164yds	158yds	DNC	DNC	DNC
10ft INT	132yds	148yds	150yds	152yds	154yds	151yds	144yds
10ft 300lb	142yds	147yds	150yds	148yds	130yds	DNC	DNC
10ft 275lb	138yds	142yds	146yds	140yds	DNC	DNC	DNC
9ft 300lb	140yds	135yds	150yds	132yds	120yds	DNC	DNC
7ft 8' 300lb	135yds	138yds	140yds	128yds	DNC	DNC	DNC



NEW

AVAILABLE SPRING 2021

TRIBAL TX-1 LITE

- Responsive Full Carbon blank is 4 piece easy to transport design
- Seaguide SIC guides (50mm starter guide on longer models)
- SHIMANO DPS reel seat
- Slim shrink handle with small EVA front grip
- Full range available from 9' length 3.0lb for stalking and 10' length for boat and short range fishing, through to 12' length Intensity for long range casting



TX1L9300	30mm	2.74m	76cm	4	248	3.00lb
TX1L10300	40mm	3.05m	83cm	4	314	3.00lb
TX1L1010INT	40mm	3.05m	83cm	4	323	3.50lb+
TX1L12300	50mm	3.66m	98cm	4	377	3.00lb
TX1L1210INT	50mm	3.66m	98cm	4	409	3.50lb+





MATCH & FEEDER RODS

SHIMANO Match and Feeder rods cover all styles of match and feeder fishing across Europe. With the growth in popularity of feeder fishing, SHIMANO's range covers everything from extreme long range fishing for bream to close range fishing for carp on man-made (Commercial) waters.

COARSE

166 AERO X7

168 AERO X5

170 AERO X1

MATCH

172 AERNOS AX MATCH

FEEDER

173 AERNOS AX FEEDER

WINKLE PICKER / COMMERCIAL

174 AERNOS WINKLE PICKER

AERNOS COMMERCIAL

FLOAT

175 CARP CRUNCHER

VENGEANCE AX

176 QUIVERTIPS



ULTRA RESPONSIVE



AERO X7

- Super light, strong, ultra responsive High Modulus Carbon + HPC + Nanosheet blanks
- Fuji Alconite KR guides (anti tangle, light frames) for 9' and 10'ft Precision Feeder
- Kigan 3D Zirconia guides for 11', 12' and 13' rods
- Fuji VSS reel seat, integrated in the high quality cork rear grip
- All rods have 3 complete spiced tip sections, not interchangeable put-in quivers, with custom tip guide sizes
- Distance Feeder models have screw-in rear extension grip
- High quality cork plus EVA rear grip handle



							INC. TIPS
FINESSE FEEDER							
AEX7FFDR9					9ft/2.74m	145.5cm	1 + 3 137g 50g 0.25oz / 0.75oz / 1oz
PRECISION FEEDER							
AEX7PRFDR10					10ft/3.05m	161cm	1 + 3 139g 60g 0.5oz / 1oz / 1.25oz
AEX7PRFDR11					11ft/3.35m	176cm	1 + 3 159g 60g 0.75oz / 1oz / 1.5oz
DISTANCE FEEDER							
AEX7DFDR12					12ft/3.66m	192cm	1 + 3 183g 90g 1.5oz / 2oz / 2.5oz
AEX7DFDR13					12ft/3.96m	140cm	2 + 3 264g 100g 2oz / 2.5oz / 3oz
DISTANCE POWER FEEDER							
AEX7DPFDR13					13ft/3.96m	140cm	2 + 3 298g 120g 3oz / 4oz / 5oz



Aero X7 Precision Feeder 10ft



Aero X7 Distance Feeder 12ft



ROD TECHNOLOGY

SPINNING

TROUT

CATFISH

STC

SPECIMEN

MATCH / FEEDER

TELESCOPIC

SALTWATER SPINNING

BOAT

SURF

EVERYTHING COVERED



AERO X5

- Light, responsive and strong High Modulus Carbon + HPC + Nanosheet blanks
- Range covers all feeder and float fishing competition styles from Commercial match carp methods through to ultra long range feeder fishing
- Super light Seaguide XOG anti-tangle guides
- SHIMANO DPS reel seat
- All feeder rods comes with 3 interchangeable carbon quiver tips
- Cork plus EVA handle
- Precision Feeder rods and Float rods have single leg intermediate guides, Distance Feeder rods have large diameter double leg guides for increased casting performance and strength



NANOSHEET



INC. TIPS

PRECISION FEEDER

AEX5PRFDR10	10ft/3.05m	161cm	2 + 3 tips	139g	60g	0.5oz / 0.75oz / 1oz
AEX5PMFDR911	9ft-11ft 2.74/3.35m	128cm	2 + 3 tips	166g	60g	0.5oz / 0.75oz / 1.5oz

DISTANCE FEEDER

AEX5DFDR12	12ft/3.66m	191cm	2 + 3 tips	192g	90g	1.5oz / 2oz / 2.5oz
AEX5DFDR13	13ft/3.96m	140cm	3 + 3 tips	256g	90g	1.5oz / 2oz / 3oz

DISTANCE POWER FEEDER

AEX5DPFDR13	13ft/3.96m	140cm	3 + 3 tips	331g	120g	3oz / 4oz / 5oz
-------------	------------	-------	------------	------	------	-----------------

DISTANCE HEAVY POWER FEEDER

AEX5DHPFDR13	13ft/3.96m	140cm	3 + 3 tips	334g	150g	3oz / 4oz / 5oz
AEX5DHPFDR14	14ft/4.27m	150cm	3 + 3 tips	362g	150g	3oz / 4oz / 5oz

PELLET WAGGLER

AEX5PW10	10ft/3.05m	157cm	2	130g	15g	
AEX5PW11	11ft/3.35m	172cm	2	148g	15g	

MATCH FLOAT

AEX5MF13	13ft/3.96m	136cm	3	162g	20g	
AEX5MF14	14ft/4.27m	147cm	3	175g	20g	



Aero X5 Pellet Waggler 10ft



Aero X5 Precision Feeder 10ft



Aero X5 Distance Heavy Power Feeder 13ft



NEW 2021 RANGE



NEW

AVAILABLE SPRING 2021

AERO X1

- Full Carbon blanks for lightweight, responsive performance with fantastic fish-playing actions
- Range covers all feeder and float fishing competition styles from Commercial match carp methods through to ultra long range feeder fishing
- SHIMANO Hardlite guides selected for the individual models use
- DPS reel seat for secure reel fixation
- All feeder rods comes with 2 interchangeable carbon quiver tips
- Cork plus EVA handle
- Finesse and Precision Feeder rods have small low profile guides, Float rods have single leg intermediate guides, Distance Feeder rods have large diameter double leg guides for increased casting performance and strength



INC. TIPS

FINESSE FEEDER

AEX1FFDR8	8ft/2.44m	129cm	2 + tips	130g	40g	0.5oz / 1oz
AEX1FFDR9	9ft/2.74m	146cm	2 + tips	145g	60g	1oz / 1.5oz

PRECISION FEEDER

AEX1PRFDR10	10ft/3.05m	162cm	2 + tips	160g	60g	1oz / 1.5oz
AEX1PRFDR11	11ft/3.35m	171cm	2 + tips	190g	70g	1oz / 2oz

DISTANCE FEEDER

AEX1DFDR12	12ft/3.66m	191cm	2 + tips	230g	90g	2oz / 3oz
AEX1DFDR13	13ft/3.96m	140cm	3 + tips	280g	90g	2oz / 3oz

DISTANCE POWER FEEDER

AEX1DHPFDR13	13ft/3.96m	140cm	3 + tips	330g	120g	3oz / 5oz
--------------	------------	-------	----------	------	------	-----------

PELLET WAGGLER

AEX1PW10	10ft/3.05m	157cm	2	180g	15g	
AEX1PW11	11ft/3.35m	172cm	2	200g	15g	

MATCH FLOAT

AEX1MF13	13ft/3.96m	136cm	3	210g	20g	
----------	------------	-------	---	------	-----	--

Aero X1 Pellet Wagglers 11ft





Aero X1 Feeder 10ft



Aero X1 Distance Power Feeder 13ft



Aero X1 Match Float 13ft



ROD TECHNOLOGY

SPINNING

TROUT

CATFISH

S.T.C.

SPECIMEN

MATCH / FEEDER

TELESCOPIC

SALTWATER SPINNING

BOAT

SURF

FAST ACTION



AERNOS AX MATCH

- Full Carbon + Nanosheet lightweight carbon blanks with a fast action
- Modern styling is complemented by great casting and fish-playing action
- SHIMANO Hardlite guides
- SHIMANO custom VSS type reel seat
- EVA front and cork rear grip

NANOSHEET

ARNSAX39F	3.90m	135cm	3	168g	20g
ARNSAX42F	4.20m	144cm	3	181g	20g
ARNSAX45F	4.50m	154cm	3	220g	20g



GREAT CASTING



AERNOS AX FEEDER

- Full Carbon + Nanosheet lightweight carbon blanks with a fast action
- Modern styling is complemented by great casting and fish-playing action
- Strong SHIMANO Hardlite feeder guides with big starter guide
- Long Cork/EVA handle for more grip when casting
- SHIMANO custom designed reel seat
- 3 balanced quivertips with large guides on long range models
- Special Precision models with an accurate action for fishing close to obstacles up to 40 meters

HANDSHEET

						INC. TIPS
ARNSAXPR60	3.30m	116cm	3 + tips	175g	60g	0.75oz / 1.5oz / 2oz
ARNSAXPR90	3.60m	126cm	3 + tips	214g	90g	1oz / 2oz / 3oz
ARNSAXLC120	3.90m	136cm	3 + tips	305g	120g	3oz / 4oz / 5oz
ARNSAXLC120L	4.20m	147cm	3 + tips	319g	120g	3oz / 4oz / 5oz
ARNSAXLC150	4.20m	147cm	3 + tips	384g	150g	3oz / 4oz / 5oz

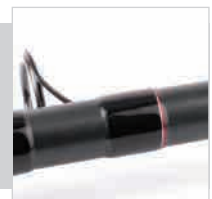



AERDOS WINKLE PICKER

- Full Carbon blank with fast action
- SHIMANO Hardlite guides
- SHIMANO VSS type reel seat
- EVA front and cork rear grip
- Supplied with 3 sensitive quiver tips

						INC. TIPS
ARNSWP24	2.40m	101cm	2	132g	40g	0.5oz / 1oz / 1.5oz
ARNSWP27	2.70m	115cm	2	149g	40g	0.5oz / 1oz / 1.5oz



AERDOS COMMERCIAL

- Designed to use in modern commercial fishing and suitable for using the latest techniques
- Full Carbon blank is very good for casting and has good fish-fighting abilities
- Moderate-fast action blank is optimized for setting the hook and fighting fish, even when light tackle is used
- Picker and feeder rods are supplied with 2 quiver tips

						INC. TIPS
ARNS8CPCR	2.44m	129cm	2 + 2 Tips	129g	40g	0.5oz / 1oz
ARNS10CFDR	3.05m	162cm	2 + 2 Tips	140g	70g	1oz / 1.5oz
ARNS911CFDR	2.74/3.35m	130cm	3 + 2 Tips	161g	70g	1oz / 2oz
ARNS10CFL	3.05m	156cm	2	146g	20g	-
ARNS911CFL	2.74/3.35m	170cm	2	152g	20g	-





NEW

CARP CRUNCHER FLOAT

- Advanced technology Full Carbon + Nanosheet blanks which are lightweight, slim and very strong
- Specially designed for handling small and mid-sized carp plus larger silver fish like bream, chub and tench
- Strong Seaguide Hero XQG+XOG guides for perfect line management
- Cork/EVA handle with custom reel seat

CRFL33	3.30m	114cm	3	184g	10-30g
CRFL36	3.60m	124cm	3	190g	10-30g
CRFL39	3.90m	134cm	3	239g	20-50g

HANDSHEET



NEW

VENGEANCE AX FLOAT

- Strong Full Carbon blanks, with power in the butt section to control larger fish
- Seaguide Atlas guides for perfect line-management
- Cork/EVA handle with custom SHIMANO VSS reel seat

VAXFL36	3.60m	124cm	3	210g	10-30g
VAXFL39	3.90m	134cm	3	254g	10-30g



ROD TECHNOLOGY

SPINNING

TROUT

CARP FISH

S.T.C.

SPECIMEN

MATCH / FEEDER

TELESCOPIC





SALTWATER SPINNING





BOAT

SURF

REPLACEMENT QUIVER TIPS

				
SUPER FEEDER TIPS AX (SOLID)				
STIPAX025SGSD	0.25oz	Small	Glass	Small
STIPAX035SGSD	0.35oz	Small	Glass	Small
STIPAX050SGSD	0.50oz	Small	Carbon	Small
STIPAX075SGSD	0.75oz	Small	Carbon	Small
STIPAX100SGSD	1oz	Small	Carbon	Small
STIPAX150SGSD	1.50oz	Small	Carbon	Small
STIPAX200SGSD	2oz	Small	Carbon	Small
STIPAX300SGSD	3oz	Small	Carbon	Small
STIPAX150NGSD	1.50oz	Normal	Carbon	Small
STIPAX600NGSD	6oz	Normal	Carbon	Small
STIPAX075SGLD	0.75oz	Small	Carbon	Large
STIPAX100SGLD	1oz	Small	Carbon	Large
STIPAX150SGLD	1.50oz	Small	Glass	Large
STIPAX200SGLD	2oz	Small	Glass	Large
STIPAX250SGLD	2.50oz	Small	Carbon	Large
STIPAX300SGLD	3oz	Small	Carbon	Large
STIPAX400SGLD	4oz	Small	Carbon	Large
STIPAX100GLD	1oz	Normal	Glass	Large
STIPAX150GLD	1.50oz	Normal	Glass	Large
STIPAX200GLD	2oz	Normal	Glass	Large
STIPAX250GLD	2.50oz	Normal	Glass	Large
STIPAX300GLD	3oz	Normal	Carbon	Large
STIPAX400GLD	4oz	Normal	Carbon	Large
STIPAX500GLD	5oz	Normal	Carbon	Large
STIPAX150LGLD	1.50oz	Large	Glass	Large
STIPAX200LGLD	2oz	Large	Glass	Large
STIPAX250LGLD	2.50oz	Large	Glass	Large
STIPAX300LGLD	3oz	Large	Carbon	Large
STIPAX400LGLD	4oz	Large	Carbon	Large
STIPAX500LGLD	5oz	Large	Carbon	Large
STIPAX600LGLD	6oz	Large	Carbon	Large
STIPAX200GLDW	2oz	Normal	-	Large
STIPAX300GLDW	2oz	Normal	-	Large
STIPAX500GLDW	2oz	Normal	-	Large

				
SUPER FEEDER TIPS AXH CARBON (HOLLOW)				
STIPAXH050SGSD	0.50oz	Small	Carbon	Small
STIPAXH075SGSD	0.75oz	Small	Carbon	Small
STIPAXH100SGSD	1oz	Small	Carbon	Small
STIPAXH150SGSD	1.5oz	Small	Carbon	Small
STIPAXH075SGLD	0.75oz	Small	Carbon	Large
STIPAXH150SGLD	1.50oz	Small	Carbon	Large
STIPAXH200SGLD	3oz	Small	Carbon	Large
STIPAXH300NGLD	3oz	Normal	Carbon	Large
STIPAXH400NGLD	4oz	Normal	Carbon	Large
FEEDER TIPS FOR COREGONUS				
STIPAXCORM	Medium	Small	Carbon	Small
STIPAXCORH	Heavy	Small	Carbon	Small
STIPAXCORL	Light	Normal	Carbon	Small
FEEDER TIPS ALIVIO				
FTGL100SGLD	1oz	Small	Glass	Large
FTGL200SGLD	2oz	Small	Glass	Large
FTCA300SGLD	3oz	Small	Carbon	Large
FTGL300SGLD	3oz	Small	Glass	Large
FTCA400SGLD	4oz	Small	Carbon	Large
FTCA600SGLD	6oz	Small	Carbon	Large
FEEDER TIPS FOR CATANA				
CATBT3Q24TIP1	15-30g	-	-	-
CATBT3Q24TIP2	30-150g	-	-	-
CATBT3Q27TIP1	15-30g	-	-	-
CATBT3Q27TIP2	30-150g	-	-	-
CATBT3Q30TIP1	15-30g	-	-	-
CATBT3Q30TIP2	30-150g	-	-	-
CATBT3Q35TIP1	15-30g	-	-	-
CATBT3Q35TIP2	30-150g	-	-	-

				
AERO X7 DISTANCE FEEDER TIPS				
AEX7DFDR12T1	1.50oz	-	-	-
AEX7DFDR12T2	2oz	-	-	-
AEX7DFDR12T3	2.50oz	-	-	-
AEX7DFDR13T1	2oz	-	-	-
AEX7DFDR13T2	2.50oz	-	-	-
AEX7DFDR13T3	3oz	-	-	-
AERO X7 DISTANCE POWER FEEDER TIPS				
AEX7DPFDR13T1	3oz	-	-	-
AEX7DPFDR13T2	4oz	-	-	-
AEX7DPFDR13T3	5oz	-	-	-
AERO X7 FINESSE FEEDER TIPS				
AEX7FFDR9T1	0.25oz	-	-	-
AEX7FFDR9T2	0.75oz	-	-	-
AEX7FFDR9T3	1oz	-	-	-
AERO X7 PRECISION FEEDER TIPS				
AEX7PRFDR10T1	0.50oz	-	-	-
AEX7PRFDR10T2	1oz	-	-	-
AEX7PRFDR10T3	1.25oz	-	-	-
AEX7PRFDR11T1	0.75oz	-	-	-
AEX7PRFDR11T2	1oz	-	-	-
AEX7PRFDR11T3	1.50oz	-	-	-
AERO FEEDER TIPS				
AEROTIP050SGSD	0.50oz	Small	-	Small
AEROTIP075SGSD	0.75oz	Small	-	Small
AEROTIP100SGSD	1oz	Small	-	Small
AEROTIP150SGLD	1.50oz	Small	-	Large
AEROTIP150SGSD	1.50oz	Small	-	Small
AEROTIP200SGLD	2oz	Small	-	Large
AEROTIP200SGSD	2oz	Small	-	Small
AEROTIP250NGSD	2.50oz	Normal	-	Small
AEROTIP300NGLD	3oz	Normal	-	Large
AEROTIP400LGLD	4oz	Large	-	Large
AEROTIP500LGLD	5oz	Large	-	Large





TELESCOPIC RODS

The popularity of fishing with telescopic rods has spread all across Europe and with many different designs now available, from traditional Bolognese fishing to monster models, there is something for everyone in the SHIMANO range

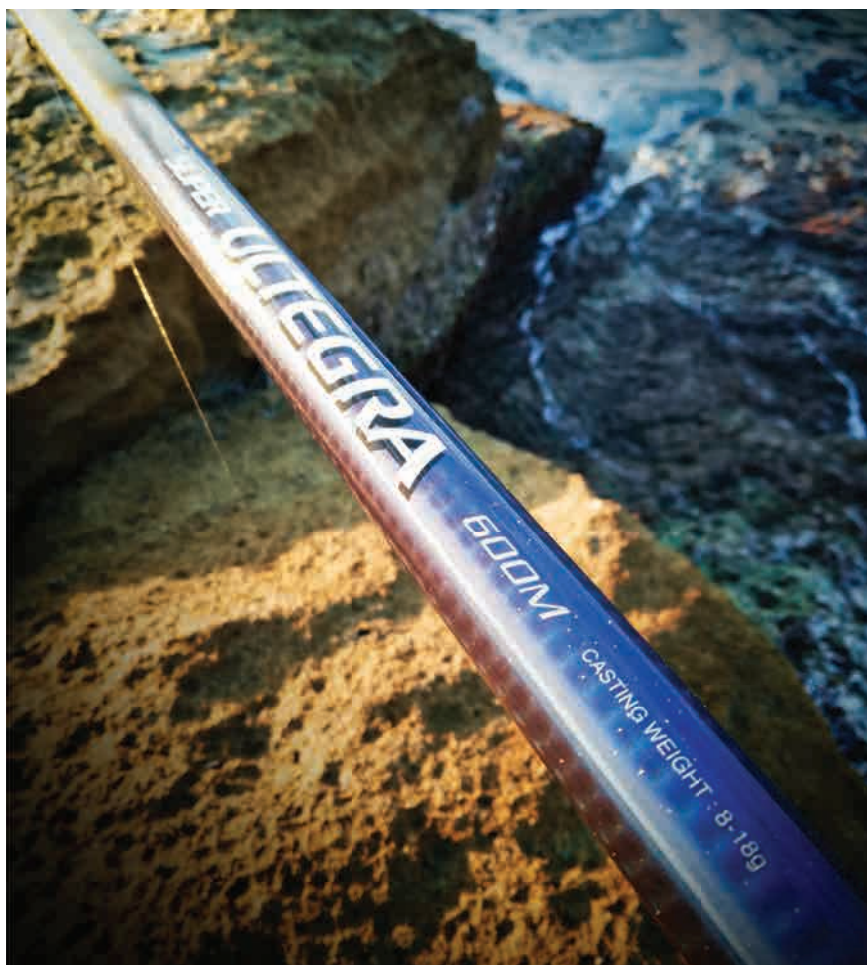

TELESCOPIC BOLO

178 ASPIRE BOLO
 SUPER ULTEGRA MEDIUM / HEAVY
 CATANA EX TE

179 TECHNIUM FAST · EXAGE FAST
 CATANA LITE / FAST
 ALIVIO DX TE

SLIM TELESCOPIC

180 CATANA STATIC BAIT
 VENGEANCE SLIM TE GT
 ALIVIO SLIM TE GT

181 VENGEANCE AX SLIM TE
 VENGEANCE ALLROUND · ALIVIO ALLROUND

TELESCOPIC

182 BEASTMASTER BX
 FORCEMASTER TELE SARGO

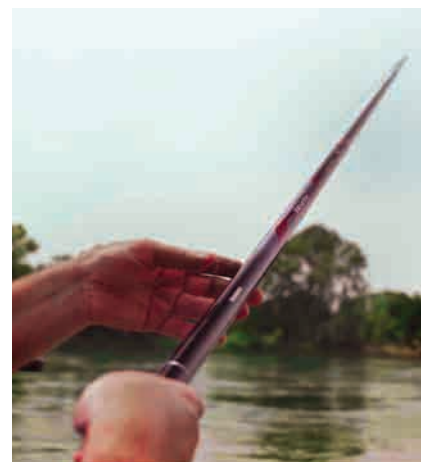



NEW

ASPIRE TE

- Utilising advanced Japanese carbon technology
- Spiral X Core blanks provide stiffness and strength while remaining light weight and responsive
- Hi-Power X Tips sections with additional torsional rigidity for increased fish-playing control
- Supplied without guides and reel seat for custom building



ASPIM60	5.90m	134cm	6	180g	8-18g
ASPIM70	6.90m	134cm	7	235g	8-18g
ASPIH60	5.90m	134cm	6	182g	5-25g
ASPIH70	6.90m	134cm	7	237g	5-25g



SUPER ULTEGRA MEDIUM / HEAVY

- High Modulus Full Carbon + HPC + Biofibre + Nanosheet blank with varnished end grip
- Softer tip for fine mono lines with additional power in the bottom half for casting and fish-playing performance
- Slim diameter butt section for comfortable and easy handling
- Special rubberised paint grip for assured handling
- No guides or reel seat enable the angler to custom build the rod



SULTEM60	6.00m	135cm	6	184g	8-18g
SULTEM70	7.00m	135cm	7	240g	8-18g
SULTEH60	6.00m	135cm	6	186g	15-25g
SULTEH70	7.00m	135cm	7	241g	15-25g



CATANA EX TE 2

- Lightweight float application (2-8 grams)
- Full Carbon blank
- Available in three sizes ranging from 6m to 8m
- Supplied without guides and reel seat

CATEXTE260	5.90m	135cm	6	205g	2-8g
CATEXTE270	6.90m	135cm	7	260g	2-8g
CATEXTE280	7.90m	135cm	8	340g	2-8g



TECHNIUM FAST

- High Modulus Full Carbon + HPC + Biofibre blank with fast action and varnished end grip
- Softer tip for fine mono lines
- Ultra light Pac Bay Minima 4 guides to increase sensitivity
- Slim diameter butt section for comfortable and easy handling
- SHIMANO plate reel seat for lightness and perfect reel positioning



TECTEGTFA60	5.90m	141cm	6	250g	2.5-15g
TECTEGTFA70	6.90m	141cm	7	315g	2.5-15g



EXAGE FAST

- Developed for all-round bolognese fishing
- High Modulus Full Carbon Blank with fast-progressive action
- Sensitive tip section for good bite detection and sufficient backbone to set the hook and fight a fish
- Pac Bay Minima 4 guides, SHIMANO reel seat and rubberized grips

EXTEGTFA60	5.90m	145cm	6	255g	2.5-15g
EXTEGTFA70	6.90m	146cm	7	324g	2.5-15g



CATANA LITE / FAST

- Full Carbon blank with progressive action and varnished end grip
- Pac Bay Minima 4 guides
- SHIMANO plate reel seat for lightness and perfect reel placement
- Cloth bag with a plastic guide protector

LITE					
CATTEGTLI40	4.00m	145cm	4	156g	1.5-10g
CATTEGTLI50	5.00m	147cm	5	255g	1.5-10g
FAST					
CATTEGTFA50	5.00m	147cm	5	261g	2.5-15g
CATTEGTFA60	6.00m	145cm	6	369g	2.5-15g



ALIVIO DX TE GT 5

- Full Carbon + Geofibre blank with a progressive/fast action
- SHIMANO Hardlite guides
- SHIMANO custom plate reel seat
- Reinforced handle section for more strength and improved balance
- Supplied with a plastic guide protector for safe transport



ALDXTEGT540	3.90m	135cm	4	221g	4-20g
ALDXTEGT550	4.90m	138cm	5	305g	4-20g
ALDXTEGT560	6.00m	138cm	6	374g	4-20g

ROD TECHNOLOGY
SPINNING
TROUT
CATFISH
S.T.C.
SPECIMEN
MATCH & FEEDER
TELESCOPIC
SALTWATER SPINNING
BOAT
SURE



NEW

CATANA STATIC BAIT

- High Modulus Full Carbon blank with powerful lifting action for using large leads with bait fish
- Designed for freshwater predators but can also be used in saltwater when fishing from rocks or marina walls
- Seaguide stainless steel guides lined with titanium oxide for strength
- SHIMANO plate reel seat

CATSBTE650GT	6.50m	136cm	7	526g	Max. 150g
CATSBTE750GT	7.50m	137cm	8	662g	Max. 150g



VENGEANCE SLIM TE GT

- Full Carbon + Geofibre provides a strong versatile blank offering excellent value
- SHIMANO Stainless Steel Hardlite guides
- SHIMANO designed reel seat

GEOFIBRE

VARTE42H	4.20m	114cm	5	341g	20-60g
VARTE42XH	4.20m	114cm	5	367g	40-100g



ALIVIO SLIM TE GT

- Composite carbon blank offers excellent combination of quality and price
- SHIMANO Stainless Steel Hardlite guides
- SHIMANO designed reel seat
- EVA handle

ALVSLTEGT27M	2.70m	96cm	5	210g	10-30g
ALVSLTEGT27H	2.70m	96cm	5	230g	30-60g
ALVSLTEGT30H	3.00m	96cm	5	250g	30-60g
ALVSLTEGT33H	3.30m	98cm	6	310g	30-60g
ALVSLTEGT36H	3.60m	98cm	6	330g	30-60g
ALVSLTEGT27XH	2.70m	96cm	5	250g	40-80g
ALVSLTEGT30XH	3.00m	96cm	5	270g	40-80g
ALVSLTEGT33XH	3.30m	98cm	6	330g	40-80g
ALVSLTEGT36XH	3.60m	98cm	6	350g	40-80g

SLIM TELESCOPIC RODS



VENGEANCE AX SLIM TE

- Full Carbon blank
- SHIMANO Stainless Steel Hardlite guides
- DPS reel seat
- Cork handle

VAXSLTE271040	2.70m	94cm	5	181g	10-40g
VAXSLTE274080	2.70m	94cm	5	188g	40-80g
VAXSLTE304080	3.00m	94cm	5	197g	40-80g
VAXSLTE334080	3.30m	94cm	6	268g	40-80g
VAXSLTE364080	3.60m	101cm	6	282g	40-80g

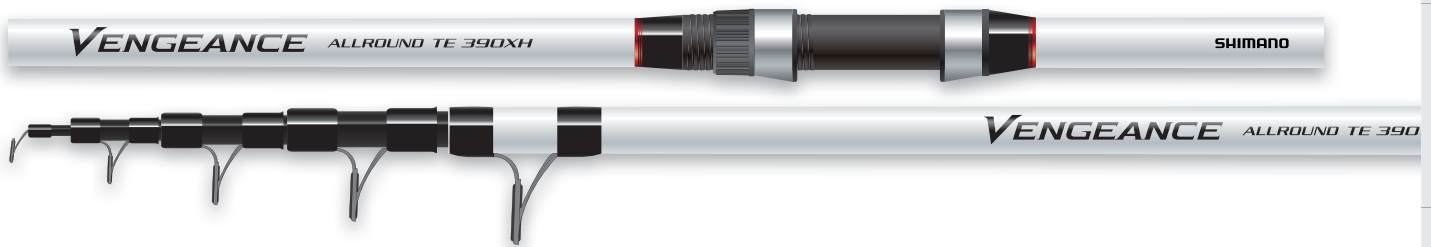

VENGEANCE ALLROUND

- Strong Full Carbon all-round rod for multiple use
- SHIMANO Hardlite guides
- SHIMANO reel seat
- Cloth bag with a plastic guide protector

VARTE360H	3.60m	108cm	5	311g	50-100g
VARTE360XH	3.60m	108cm	5	326g	75-150g
VARTE390H	3.90m	118cm	5	324g	50-100g
VARTE390XH	3.90m	118cm	5	328g	75-150g



ALIVIO ALLROUND

- Strong Full Carbon all-round rod for multiple use
- SHIMANO Hardlite guides
- SHIMANO reel seat
- Poly Bag and a guide protector

ALVARTE300H	3.00m	97cm	4	297g	50-100g
ALVARTE350H	3.50m	97cm	5	426g	50-100g

ROD TECHNOLOGY
SPINNING
TROUT
CATFISH
S.T.C.
SPECIMEN
MATCH & FEEDER
TELESCOPIC
SALTWATER SPINNING
BOAT
SURE



Beast Master BX TELE

- Full Carbon + Biofibre delivers excellent strength a power to one of our most powerful telescopic models
- SHIMANO Stainless Steel Hardlite guides
- S.D.R. creates a smooth seamless playing action

BMBXTE11600XXH | 6.00m | 142cm | 6 | 496g | 110g

BIOFIBRE



ForceMaster TELE SARGO

- Telescopic rod equipped with "Slide'n Grip" reel seat
- With its reduced weight, it is extremely light and very powerful
- Made from Full Carbon
- Ideal for suspending fish with considerable weight from cliffs
- Can also be used for casting

FMTESAR50XXH | 5.00m | 115cm | 5 | 480g | 50-150g





SALTWATER SPINNING RODS

SHIMANO salt water spinning rods cover all of the modern spinning styles found across Europe and the tropics from lightweight shad and jig fishing to heavyweight tuna and GT methods where strength is of the upmost importance. This year sees the introduction of several new models, specifically designed for the very latest techniques, that are now being used worldwide.

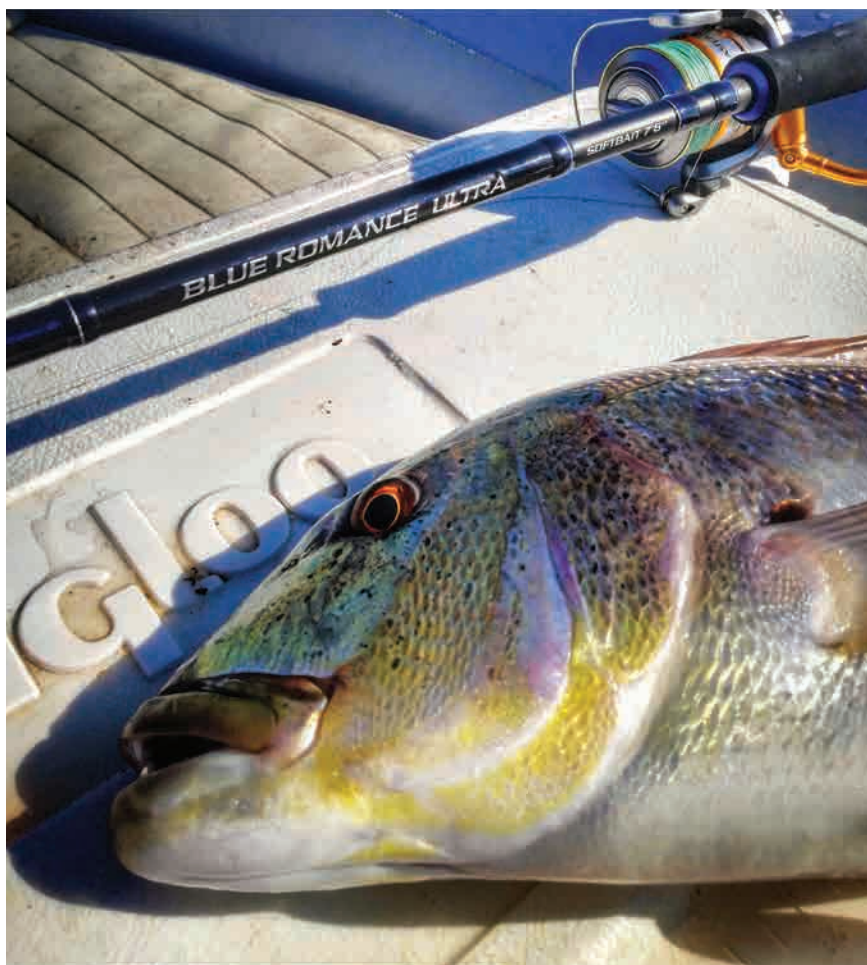

BLUE ROMANCE

184 BLUE ROMANCE ULTRA

186 BLUE ROMANCE AX

SEA BASS

188 LUNAMIS

190 DIALUNA

191 BASSTERRA SEA BASS · VENGEANCE CX

LIGHT ROCK FISHING

192 BASSTERRA

EGING

193 SEPHIA BB · TECHNIUM EGING

VENGEANCE EGING

SEA TROUT

194 ASPIRE SEA TROUT

195 TECHNIUM SEA TROUT

SW MATCH/FLOAT

195 SONARA SW MATCH

OFFSHORE CASTING

195 AERNOS POWER GAME

GRAPPLER TYPE C

196 OCEA PLUGGER FLEX

OFFSHORE JIGGING

198 GAME TYPE JIGGING

198 GRAPPLER TYPE J

199 GAME TYPE LIGHT JIGGING

199 GRAPPLER BB

200 SPEEDMASTER JIG · VENGEANCE JIG BOAT

TAI RUBBER

200 ENGETSU BB · TECHNIUM TAI RUBBER





BLUE ROMANCE ULTRA STICKBAIT

- Special rods for fishing with stick baits
- Strong yet lightweight Spiral X construction for increased torsional and compression rigidity
- Lightweight Ci4+ reel seat for perfect fixation of the reel
- Very strong, stiff and lightweight blank
- Fuji Stainless Steel K-Type SiC guides
- EVA grip for good control, easy to clean



BRUSB763060

2.28m	118cm	2	140g	30-60g



BLUE ROMANCE ULTRA JERKBAIT

- Special rods for fishing with jerkbaits
- Strong yet lightweight Spiral X construction for increased torsional and compression rigidity
- Lightweight Ci4+ reel seat for perfect fixation of the reel
- Very strong, stiff and lightweight blank
- Fuji Stainless Steel K-Type SiC guides
- EVA grip for good control, easy to clean



BRUJBT651040

BRUJBT702050

BRUJBT76721

1.95m	160cm	2 (SH)*	130g	10-40g
2.13m	177cm	2 (SH)*	140g	20-50g
2.28m	193cm	2 (SH)*	140g	7-21g



BLUE ROMANCE ULTRA SOFTBAIT

- Special rods for fishing with softbaits
- Strong yet lightweight Spiral X construction for increased torsional and compression rigidity
- Lightweight Ci4+ reel seat for perfect fixation of the reel
- Very strong, stiff and lightweight blank
- Fuji Stainless Steel K-Type SiC guides
- EVA grip for good control, easy to clean



BRUSBT70721

BRUSBT721030

BRUSBT761540

BRUSBT703080

BRUSBT832070

2.13m	177cm	2 (SH)*	120g	7-21g
2.18m	182cm	2 (SH)*	125g	10-30g
2.28m	192cm	2 (SH)*	135g	15-40g
2.13m	177cm	2 (SH)*	150g	30-80g
2.51m	129cm	2	160g	20-70g



BLUE ROMANCE ULTRA LIGHTGAME

- Special rods for light sea game fishing
- Strong yet lightweight Spiral X construction for increased torsional and compression rigidity
- Lightweight Ci4+ reel seat for perfect fixation of the reel
- Very strong, stiff and lightweight blank
- Fuji Stainless Steel K-Type SiC guides
- EVA grip for good control, easy to clean

BRULG74512



2.23m



115cm



2



80g



5-12g



BLUE ROMANCE ULTRA POWERGAME

- Exclusive Spiral X carbon blank delivers power, lightness and high performance characteristics for tackling powerful blue water specimens
- Custom designed SHIMANO Ci4+ reel seat
- Fuji Stainless SiC anti tangle K-Type Double leg guides for strength and great casting performance
- EVA grip for good control, easy to clean

BRUPG8040100



2.44m



126cm



2



215g



40-100g

BRUPG9040100

2.74m

141cm

2

240g

40-100g

BRUPG10040100

3.05m

156cm

2

275g

40-100g





BLUE ROMANCE AX POWERGAME

- Hi-Power X blank for increased strength and less twist when casting and playing fish
- Lightweight SHIMANO Ci4+ reel seat and split EVA grips
- Saltwater resistant stainless steel Fuji Alconite K guides for trouble free casting with both braid and mono
- Longer lengths are perfect for long range casting of medium and large lures from the shore or boat, shorter lengths are more suited to boat fishing



BRAXPG704080	2.13m	111cm	2	148g	40-80g
BRAXPG804080	2.44m	126cm	2	166g	40-80g
BRAXPG902060	2.74m	142cm	2	185g	20-60g
BRAXPG904080	2.74m	142cm	2	202g	40-80g
BRAXPG9104080	3.00m	155cm	2	246g	40-80g
BRAXPG10104080	3.30m	170cm	2	295g	40-80g



BLUE ROMANCE AX SHORE JIGGING

- Hi-Power X blank for increased strength and less twist when casting and playing fish
- Lightweight SHIMANO Ci4+ reel seat and split EVA grips
- Saltwater resistant stainless steel Fuji Alconite K guides for trouble free casting with both braid and mono
- Excellent long range casting performance enables more water to be fished from the shore



BRAXSJ965080	2.90m	150cm	2	231g	50-80g



BLUE ROMANCE AX STICKBAIT

- Hi-Power X blank for increased strength and less twist when casting and playing fish
- Lightweight SHIMANO Ci4+ reel seat and split EVA grips
- Saltwater resistant stainless steel Fuji Alconite K guides for trouble free casting with both braid and mono
- Excellent casting performance designed for fishing surface and sub-surface stickbaits



BRAXSB763060	2.28m	192cm	2(SH)*	145g	30-60g



BLUE ROMANCE AX JERKBAIT

- Hi-Power X blank for increased strength and less twist when casting and playing fish
- Lightweight SHIMANO C14+ reel seat and split EVA grips
- Saltwater resistant stainless steel Fuji Alconite K guides for trouble free casting with both braid and mono
- A versatile rod for all medium sized hardbait fishing with the correct action for twitching and jerking lures



BRAXJBT701030	2.13m	177cm	2(SH)*	139g	10-30g
BRAXJBT761540	2.28m	193cm	2(SH)*	147g	15-40g



BLUE ROMANCE AX SOFTBAIT

- Hi-Power X blank for increased strength and less twist when casting and playing fish
- Lightweight SHIMANO C14+ reel seat and split EVA grips
- Saltwater resistant stainless steel Fuji Alconite K guides for trouble free casting with both braid and mono
- Sensitive tip section designed for use with softbaits



BRAXSBT702050	2.13m	177cm	2(SH)*	137g	20-50g
BRAXSBT721030	2.18m	182cm	2(SH)*	126g	10-30g
BRAXSBT76721	2.28m	193cm	2(SH)*	118g	7-21g



BLUE ROMANCE AX LIGHT GAME

- Hi-Power X blank for increased strength and less twist when casting and playing fish
- Lightweight SHIMANO C14+ reel seat and split EVA grips
- Saltwater resistant stainless steel Fuji Alconite K guides for trouble free casting with both braid and mono
- Lightweight design is perfect for rock fishing with small baits of all kinds. Excellent playing action at close range



BRAXLG74512	2.23m	115cm	2	86g	5-12g



THE ULTIMATE LONG CASTING SEA BASS ROD

NEW

LUNAMIS

- The ultimate in rod carbon technology from the JDM collection featuring Spiral X Core + Hi-Power X + Nanopitch + Muscle Carbon
- Moderate/Fast action designed for long range lure casting for sea bass and other saltwater predators
- SHIMANO X guides with Fuji Titanium SiC
- SHIMANO Ci4+ Perfection reel seat for secure reel fixing
- Unique Carbon Monocoque handle for weight reduction and sensitivity

20LUNAMISS90L	2.74m	141cm	2	116g	5-21g
20LUNAMISS86ML	2.59m	133cm	2	118g	6-25g
20LUNAMISS90ML	2.74m	141cm	2	122g	6-25g
20LUNAMISS86M	2.59m	133cm	2	124g	7-35g
20LUNAMISS96M	2.90m	149cm	2	136g	7-35g
20LUNAMISS96MH	2.90m	149cm	2	150g	10-45g



ROD TECHNOLOGY
SPINNING
TROUT
CATFISH
SITC
SPECIMEN
MATCH & FEEDER
TELESCOPIC
SALTWATER SPINNING
BOAT
SURF

SEA BASS RODS

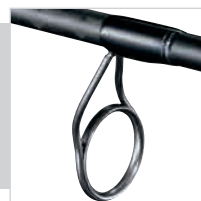
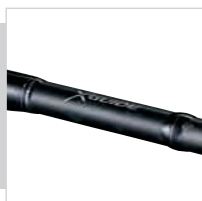

ROD TECHNOLOGY

SPINNING

TROUT

CATFISH

S.T.C.

SPECIMEN

MATCH & FEEDER

TELESCOPIC

SALTWATER SPINNING

BOAT

SURE



DIALUNA

- Spiral X and Hi-Power X construction with moderate-fast action for extreme distance and precision casting
- Fuji SiC K guides
- Ci4+ reel seat with EVA handle
- Plastic case for comfortable transport

DLNXS900MLMB	2.74m	73cm	4	152g	6-28g
18DLNS86LS	2.59m	133cm	2	108g	3-21g
18DLNS90ML	2.74m	141cm	2	128g	6-32g
18DLNS96M	2.90m	149cm	2	141g	8-45g
18DLNS100MH	3.05m	156cm	2	170g	10-56g



MoonShot

- Muscle Loop carbon construction
- Designed for Sea Bass at long range on hardbaits
- Fuji SiC K guides
- SHIMANO original reel seat
- EVA split grip handle
- High quality cloth bag

MOONS900ML	2.74m	141cm	2	134g	6-28g
MOONS906M	2.90m	149cm	2	167g	8-42g





NEW

AVAILABLE SPRING 2021

BASSTERRA SEA BASS

- Full Carbon blank + Diaflash for powerful, responsive casting performance and total fish-playing control
- Medium fast action for enhanced long range casting performance from either shore or boat
- Corrosion resistant tangle-free Seaguide XOG Stainless Steel guides
- Custom designed VSS reel seat with EVA handle
- Ideal for both softbait and hardbait fishing

BSTRSB80M	2.44m	125cm	2	134g	6-28g
BSTRSB90M	2.74m	139cm	2	145g	7-30g
BSTRSB90MH	2.74m	139cm	2	160g	12-38g
BSTRSB96H	2.89m	149cm	2	220g	15-60g

DIAFASH



NEW

VENGEANCE CX SEA BASS

- Entry level Sea Bass rod offering a wide range of models to suit different lure sizes and preferences from long range shore fishing to shorter range boat fishing
- Full Carbon blank
- Medium fast action for enhanced casting performance
- Corrosion resistant Stainless Steel guides with lined centres suitable for braid main lines
- Custom designed VSS reel seat with EVA handle

SVCX21SBM	2.10m	114cm	2	141g	7-35g
SVCX21SBMH	2.10m	114cm	2	149g	10-50g
SVCX21SBH	2.10m	114cm	2	155g	15-60g
SVCX24SBM	2.40m	130cm	2	167g	7-35g
SVCX24SBMH	2.40m	130cm	2	172g	10-50g
SVCX24SBH	2.40m	130cm	2	185g	15-60g
SVCX27SBMH	2.70m	145cm	2	140g	10-50g
SVCX27SBH	2.70m	145cm	2	149g	15-60g



ROD TECHNOLOGY

SPINNING

TROUT

CATFISH

S.T.C.

SPECIMEN

MATCH & FEEDER

TELESCOPIC

SALTWATER SPINNING

BOAT

SURF

LIGHT ROCK FISHING

NEW

AVAILABLE SPRING 2021

BASSTERRA LRF

- Full Carbon blank + Diaflash for responsive performance and total fish-playing control in tight situations around underwater snags and rocks
- Fast action with a solid tip for maximum feel and bite registration
- Corrosion resistant tangle-free Seaguide XOG Stainless Steel guides
- Custom designed VSS reel seat with EVA handle
- Available in light power (1-11g casting weight) for super sensitive situations and light-plus power (3-15g casting weight) for more demanding situations where slightly bigger lures are preferred



BSTRLRF72L
BSTRLRF80LP



2.18m



113cm



2



95g



1-11g



2.44m



125cm



2



115g



3-15g





Sephia BB

- Strong but very light Hi-Power X blank with the correct moderately fast, forgiving action for squid fishing
- Anti tangle Fuji Alconite K-type guides for maximum casting performance
- SHIMANO custom designed reel seat with EVA grip
- Red and black colour graphics match perfectly with the Sephia BB reel



18SEPHIABBS83ML



2.51m



129cm



2



100g



1.8-3.8g



TECHNIUM EGING

- Very responsive High Modulus Full Carbon blank in a striking blue colour with black details
- The perfect blank action for long range casting with EGI lures
- Lightweight Fuji Stainless Steel FazLite KR type guides for faultless performance
- SHIMANO VSS reel seat with ergonomic EVA handle
- Unique 'squid ink' design graphics

TECEGI83M



2.51m



130cm



2



122g



2.5-4.0g



NEW

VENGEANCE EGING

- Responsive EGI (Squid) rod offering great value for money
- Full Carbon blank
- 2.5m length delivers versatile performance from all fishing positions with long range casting characteristics
- Suitable for EGI lures sizes 2.0 - 3.5.
- Corrosion resistant Stainless Steel guides with lined centres suitable for braid main lines
- Custom designed VSS reel seat with EVA handle

VENGEI83M



2.50m



132cm



2



116g



2.0-3.5g



ULTRA SLIM BLANK

NEW

ASPIRE SEA TROUT

- Ultra slim blank built using SHIMANO'S leading carbon technology - Spiral X Core, Hi-Power X and Nanopitch
- Moderately fast responsive action for long distance casting using light lures, spoons and rubber shads
- Power reserves in lower part of the rod for excellent fish-fighting control, especially in shallow water
- Fuji Stainless Steel SiC K-Type guides improves casting performance
- Custom designed SHIMANO Ci4+ reel seat with high quality cork handle



					
ASPSTTG90ML	2.74m	-	2	-	5-25g
ASPSTTG90M	2.74m	-	2	-	7-35g
ASPSTTG96MH	2.89m	-	2	-	10-40g
ASPSTTG100M	3.05m	-	2	-	7-35g
ASPSTTG100MH	3.05m	-	2	-	10-40g





TECHNIUM SEA TROUT

- High Modulus Full Carbon + Nanosheet carbon produces lightweight and responsive blank
- Moderately fast action is optimised for long distance casting with light lures
- Fuji Stainless Steel FazLite K-Type guides improve casting performance
- Custom designed SHIMANO reel seat with high quality cork handle and rear grip
- Perfect action for casting small hardbaits and spoons

TECHST91	2.76m	142cm	2	149g	5-35g
TECHST96	2.89m	149cm	2	160g	10-40g
TECHST101	3.08m	158cm	2	178g	15-45g
TECHST111	3.37m	172cm	2	200g	15-45g

NANOSHEET



Sonora SW MATCH

- New range of saltwater match rods designed for float fishing
- Strong Composite blank with progressive action
- Lightweight SHIMANO Hardlite guides
- Full EVA handle with DPS reel seat
- Available in 3 piece and telescopic models in both fast action and stronger specimen actions
- Designed for float fishing in harbours, docks and from rocks for small saltwater fish

SONSWM420FA	4.20m	148cm	3	260g	20g
SONSWM450SP	4.50m	158cm	3	290g	30g
SONSWMTE420FA	4.20m	115cm	8	306g	20g
SONSWMTE450SP	4.50m	122cm	9	315g	30g





AERNO AX POWERGAME

- High Modulus Full Carbon blank produces responsive, powerful action suited to playing hard fighting fish
- Tough Seaguide guides suitable for braid and mono
- SHIMANO DPS reel seat
- EVA handle for assured grip with graphite gimble to aid fish-playing

SARNSAX210PG	2.10m	110cm	2	235g	60-120g
SARNSAX240PG	2.40m	125cm	2	261g	60-120g



GRAPPLER *Type C*

- Super strong Spiral X + Hi-Power X blanks are capable of fighting big offshore fish like tuna and kingfish
- Fuji Alconite K-type + SiC(tip) guides for lightness, strength and saltwater resistance
- Fuji DPS / T-DPS / SHIMANO Ci4+ Perfection / Ci4+ Multi Palming Touch handles depending on model
- Four models available designed for a unique style of fishing - jigging, light jigging, slow jigging and casting

19GRTC573ML	2.21m	170cm	2(SH)*	209g	80g
19GRTC580M	2.44m	183cm	2(SH)*	256g	100g
19GRTC577MH	2.31m	170cm	2(SH)*	274g	120g
19GRTC582H	2.49m	182cm	2(SH)*	326g	150g





HARD FIGHT

OCEA PLUGGER FLEX LIMITED

- Spiral X and Hi-Power X carbon construction with excellent power
- Medium fast tip action for hard fighting fish
- Fuji SiC K-type guides
- Fuji DPS reel seat
- EVA handle
- Soft case bag



OPFLSLTD83MH	2.52m	185cm	2 (SH)*	350g	110g
OPFLSLTD83H	2.52m	185cm	2 (SH)*	355g	130g



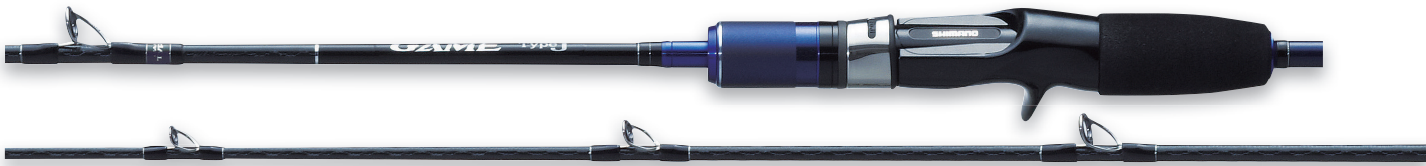

NEW

GAME *Type J*

- Spiral X Core and Hi-Power X construction for increased strength and reduction to twisting whilst jigging and fish-playing
- Jigging models have moderate-fast action and Slow models have moderate-slow actions to enhance lure action
- Fuji Stainless SiC guides
- Ci4+ custom designed reel seat
- EVA split grip handle
- High quality cloth bag

20GAMETYPJS5105	1.78m	128cm	2(SH)*	187g	250g
20GAMETYPJS624	1.88m	139cm	2(SH)*	162g	210g
20GAMETYPJB605	1.83m	140cm	2(SH)*	175g	250g
SLOW					
20GAMETSJB661	1.98m	151cm	2(SH)*	123g	160g
20GAMETSJB662	1.98m	151cm	2(SH)*	128g	200g
20GAMETSJB663	1.98m	151cm	2(SH)*	132g	260g
20GAMETSJB664	1.98m	151cm	2(SH)*	139g	330g



GRAPPLER *Type J*

- The Spiral X + Hi-Power X carbon blanks are super strong and capable of fighting big offshore fish like tuna and kingfish
- Spinning, jigging, light jigging, slow jigging and casting models available
- Fuji Alconite K-type guides + SiC tip
- Fuji DPS / T-DPS / SHIMANO Ci4+ Perfection / Ci4+ Multi Palming Touch reel seats depending on model selection
- EVA handle
- 1 + 1 handle design produces seamless fighting action and shorter transport length

SPINNING					
19GRTJS603	1.83m	131cm	2(SH)*	165g	180g
19GRTJS604	1.83m	130cm	2(SH)*	172g	210g
19GRTJS605	1.83m	130cm	2(SH)*	180g	250g
19GRTLJS632	1.91m	146cm	2(SH)*	125g	40-160g
BAITCASTING					
19GRTSJB682	2.03m	156cm	2(SH)*	115g	200g
19GRTSJB683	2.03m	156cm	2(SH)*	120g	260g
19GRTSJB684	2.03m	156cm	2(SH)*	125g	330g
19GRTLJB632	1.91m	144cm	2(SH)*	112g	50-160g





GAME TypeLJ

- Spiral X and Hi-Power X carbon construction
- Fast progressive action
- Fuji Titanium top guide + Stainless SiC K guide
- C14+ custom designed reel seat
- EVA split grip handle
- High quality cloth bag

17GAMETLJS632



1.91m



191cm



1



120g



50-150g



GRAPPLER BB

- Fast progressive action
- Fuji SiC K-type guides
- SHIMANO custom design spinning reel seat
- EVA split grip handle

GLPJBBS632



1.91m



147cm



2 (SH)*



118g



150g

GLPJBBB632

1.91m

143cm

2 (SH)*

109g

150g





SpeedMaster JIG

- High Modulus Full Carbon blanks
- Sensitive tips combined with extreme power
- Fuji K guides for unbeatable casting performance
- Ergonomic EVA handle to enhance user experience

16SPMJS603
16SPMJS604
16SPMJS605
16SPMJB634
SPMSJB684
SPMSJB685

Length	Tip Length	Reel Seats	Weight	Load
1.84m	131cm	2 (SH)*	183g	60-160g
1.84m	131cm	2 (SH)*	185g	90-200g
1.84m	131cm	2 (SH)*	192g	110-240g
1.90m	145cm	2 (SH)*	141g	90-200g
2.07m	207cm	2 (SH)*	156g	150-250g
2.07m	207cm	2 (SH)*	150g	180-300g



VENGEANCE JIGGING BOAT

- Full Carbon blank construction for assured strength
- Designed specifically for vertical jigging
- SHIMANO Hardlite stainless steel guides suitable for braid and mono
- DPS reel seat
- EVA handle for comfort and secure handling

VJBT183MHS

Length	Tip Length	Reel Seats	Weight	Load
1.83m	118cm	2 (SH)*	320g	100-300g



TECHNIUM TAI RUBBER

- Lightweight Full Carbon blank with progressive action for light jig and tai rubber lure presentation
- Solid tip for extra sensitive bite detection
- Seaguide Hero guides
- Ergonomic SHIMANO custom reel seat
- Split EVA handle

TECTR72M
TECTR72H

Length	Tip Length	Reel Seats	Weight	Load
2.18m	113cm	2	116g	130g
2.18m	113cm	2	126g	220g



ENGETSU BB

- Selected from the Japanese product range for light Tai Rubber jigging
- Solid Taftec Alpha tip produces the perfect action to work lures correctly and spot sensitive bites
- Fuji SiC K-type guides
- SHIMANO custom design casting reel seat

ENGTBBB69MS

Length	Tip Length	Reel Seats	Weight	Load
2.06m	158cm	2	105g	40-130g

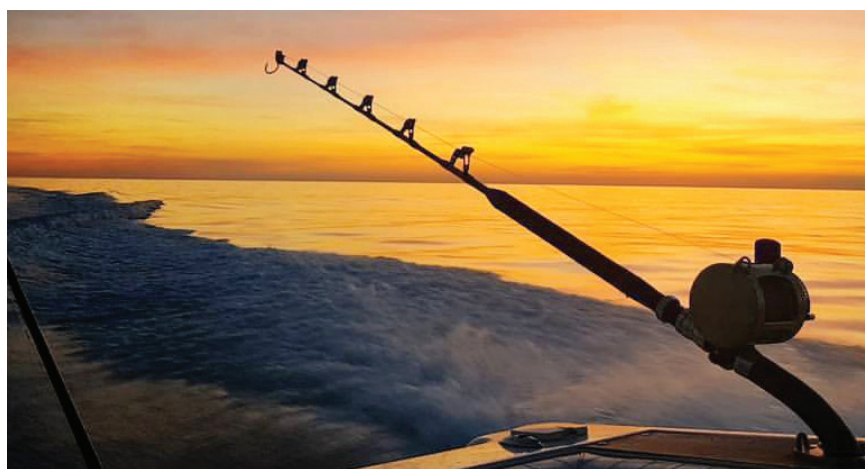

BOAT RODS

From powerful trolling rods designed for tuna and marlin to lightweight saltwater jigging rods, SHIMANO Boat Rod range covers everything needed for the salt water angler.



STAND-UP

- 202 TIAGRA ULTRA GAME
TIAGRA ULTRA A STAND-UP
- 203 TIAGRA HYPER STAND-UP
- 204 TIAGRA XTR-A STAND-UP
TYRNOS A STAND-UP

- 205 TLD STAND-UP · VENGEANCE STAND-UP

TROLLING

- 206 TYRNOS TROLLING · TYRNOS A TROLLING LITE
CATANA TROLLING LITE

BOAT

- 207 SPEEDMASTER DDM · BEASTMASTER CX BOAT
VENGEANCE AX BOAT

SLIM BOAT

- 208 ASPIRE BOAT · TECHNIUM BOAT SLIM
- 209 BEASTMASTER BX BOAT SLIM
VENGEANCE AX BOAT SLIM

TELE BOAT

- 210 BEASTMASTER AX TE BOAT QUIVER
ALIVIO BX TE

BOAT QUIVER

- 211 BEASTMASTER AX BOAT QUIVER
- 212 CATANA BOAT QUIVER · ALIVIO BOAT QUIVER
SONARO BOAT QUIVER

PILK

- 213 BEASTMASTER PILK · VENGEANCE PILK

INNERGUIDE

- 214 BEASTMASTER CX INNERGUIDE

DOWNRIGGER

- 214 BEASTMASTER BX DOWNRIGGER
CATANA AX DOWNRIGGER

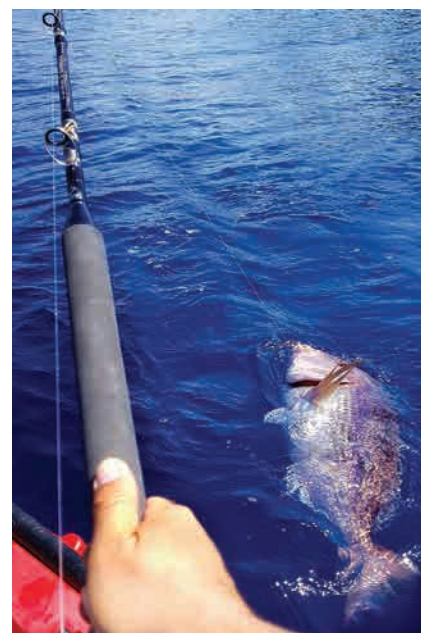



NEW AVAILABLE SPRING 2021

TIAGRA ULTRA GAME

- SHIMANO'S flagship trolling rod built with the latest carbon technology - Spiral X + Hi-Power X
- Alps BRX Stainless Steel roller guides
- Winn grip front grip and woven carbon rear grip
- Pac Bay Black Aluminium reel holder
- Carbon butt in both straight and bent configurations
- High class Neoprene bag



TIULT50STP	1.65m	-	2 (SH)*	-	50lbs
TIULT80STP	1.65m	-	2 (SH)*	-	80lbs

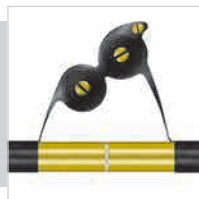

TIAGRA ULTRA A STAND-UP LTD EDITION

- Full Carbon + HPC + Biofibre with NanoAlloy technology and Twist Control
- Ultra light carbon roller guides
- Pac Bay aluminium butt reel seat
- Carbon butt grip

TIUASTP3050LE	1.65m	127cm	2 (SH)*	663g	30-50lb
TIUASTP5080LE	1.65m	127cm	2 (SH)*	771g	50-80lb



LEATHER WINN GRIP

TIAGRA HYPER STAND-UP

- Strong, powerful Full Carbon + HPC + Nanosheet blank, resulting in reduced diameter and higher torsional twist resistance
- Full carbon butt section 30lb - straight, 50lb/80lb - bent
- Black leather Winn Grip for maximum grip and comfort even in wet conditions
- Alloy gimbal to secure the rod to the fighting belt
- Pac Bay Channel Lock Black Aluminium reel holder
- Strong, lightweight Aftco roller guides AFTCO HD (30/50) / WO (80)



18TIH30SUBS	1.75m	133cm	2 (SH)*	792g	30lb
18TIH50SUBB	1.73m	131cm	2 (SH)*	878g	50lb
18TIH80SUBB	1.68m	119cm	2 (SH)*	1188g	80lb

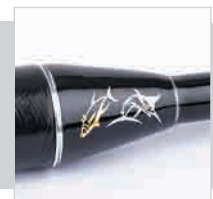
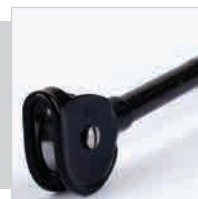



TIAGRA XTR-A STAND-UP

- Full Carbon + HPC + Biofibre blank
- ALPS aluminium reel seat
- SHIMANO aluminium roller guides with stainless steel rollers
- EVA front grip
- Aluminium butt



TIXTRASPTR80B



1.65m



123cm



1+1



880g



80lb



TYRNOS A STAND-UP

- Full Carbon + HPC + Biofibre blank with Twist Control
- ALPS heavy duty guides with SiC lining for the 30lb model
- SHIMANO aluminium roller guides with stainless steel rollers for 50 and 80lb models
- Ergonomic shaped EVA front grip
- One piece construction
- Neoprene bag



TYRASTP30R



1.65m



165cm



1



660g



30lb

TYRASTP50R

1.65m

165cm

1

685g

50lb

TYRASTP80R

1.65m

165cm

1

716g

80lb





TLD A STAND-UP

- Thin but strong blank made of Full Carbon+ Biofibre
- SHIMANO Stainless Steel Hardlite guides on 20 lb model and SHIMANO roller guides on the other models
- Pac Bay Aluminium butt reel seat
- Perfect choice to fish for big tuna with a reasonable priced, powerful and trustworthy stand-up rod



TLDASTP20
TLDASTP30R
TLDASTP50R
TLDASTP80R

TLDASTP20	1.68m	168cm	1	495g	20lb
TLDASTP30R	1.68m	168cm	1	701g	30lb
TLDASTP50R	1.68m	168cm	1	734g	50lb
TLDASTP80R	1.68m	168cm	1	752g	80lb



VENGEANCE STAND-UP

- Composite carbon blank offers good value for money combined with reliable performance
- SHIMANO Stainless Steel Hardlite guides
- Aluminium butt reel seat
- EVA profiled grips for secure handling

VSTP816
VSTP1620
VSTP2030
VSTP3050

VSTP816	1.65m	165cm	1	439g	8-16lb
VSTP1620	1.65m	165cm	1	494g	16-20lb
VSTP2030	1.65m	165cm	1	497g	20-30lb
VSTP3050	1.65m	165cm	1	511g	30-50lb





TYRNOS TROLLING

- Full Carbon + HPC + Biofibre blank delivers outstanding performance across the full range of models
- SHIMANO Stainless Steel roller guides on 50 & 80 models
- Pac Bay aluminium butt reel seat
- EVA front grip for secure handling
- Aluminium rear grip



TYRTRL50	2.13m	172cm	2 (SH)*	1079g	50lb
TYRTRL80	2.13m	165cm	2 (SH)*	1285g	80lb
TYRTRL80B	2.13m	152cm	2 (SH)*	1429g	80lb
TYRTRL130	2.13m	165cm	2 (SH)*	1484g	130lb
TYRTRL130B	2.13m	152cm	2 (SH)*	1612g	130lb



TYRNOS A TROLLING LITE

- Full Carbon + HPC + Biofibre
- ALPS heavy duty guides with SiC linings
- Pacific Bay aluminum heavy duty reel seat
- Pacific Bay aluminum gimbal
- Ergonomic shaped EVA front grip
- In the butt joint construction
- Neoprene bag



TYRARTRLL6	2.19m	178cm	2 (SH)*	561g	6lb
TYRARTRLL12	2.19m	178cm	2 (SH)*	570g	12lb
TYRARTRLL16	2.19m	178cm	2 (SH)*	630g	16lb
TYRARTRLL20W	2.19m	178cm	2 (SH)*	638g	20lb



CATANA CX TROLLING LITE

- Full Carbon blank with lightweight fast action
- Seaguide XRES guides
- Pac Bay aluminium reel seat
- EVA profiled grips with aluminium gimbal

CATCXTRLL6	2.19m	178cm	2 (SH)*	536g	6lb
CATCXTRLL12	2.19m	178cm	2 (SH)*	536g	12lb
CATCXTRLL16	2.19m	178cm	2 (SH)*	587g	16lb
CATCXTRLL20	2.19m	178cm	2 (SH)*	591g	20lb



SpeedMaster DENDOU-MARU

- Full Carbon + HPC + Biofibre blank designed for very deep fishing
- SHIMANO Stainless Steel SiC guides
- Pac Bay aluminium butt reel seat
- Perfect for electric Dendou Maru reels



SMDDM761000	2.29m	164cm	2 (SH)*	644g	1000g
SMDDM761500	2.29m	164cm	2 (SH)*	684g	1500g



BeastMaster CX BOAT

- Full Carbon + HPC + Biofibre for strength and power
- SHIMANO Hardlite Guides
- DPS type reel seat
- EVA grips for comfort and durability



BMCXBT2030	2.28m	115cm	2	599g	20-30lb
BMCXBT3050	2.28m	115cm	2	5600g	30-50lb



VENGEANCE AX BOAT

- Composite blank for strength and more fish control
- SHIMANO Hardlite Guides
- DPS type reel seat
- EVA grips for comfort and durability in saltwater

VAXB210H	2.10m	110cm	2	381g	300g
VAXB240H	2.40m	125cm	2	428g	300g
VAXB270H	2.70m	140cm	2	477g	300g
VAXB270XXH	2.70m	140cm	2	530g	500g
VAXB300XXH	3.00m	155cm	2	583g	500g



ASPIRE BRAID BOAT

- Spiral X + Hi-Power X blank is light, slim and incredibly strong with a fast, powerful action
- Fuji Triangle SiC braid guides are lightweight, strong, and saltwater corrosion resistant
- Special front grip material for a perfect hold and moisture absorption when fighting big fish
- SHIMANO Custom Aluminium reel seat for secure reel placement with no movement
- Rubber butt cap with Fuji Full Aluminium Gimbal

ASBT762030B

ASBT763050B

				
2.29m	166cm	2 (SH)*	435g	20-30lb
2.29m	166cm	2 (SH)*	450g	30-50lb



TECHNIUM BOAT SLIM

- High Modulus Full Carbon blank is light and slim with a fast, powerful action
- SHIMANO Stainless Braid guides and Seaguide Stainless DL guides (TBTSL7112030 model)
- Full EVA handle
- Fuji DPS reel seat
- Rubber Fuji gimbal for comfortable fish-playing
- Models TBTSL821220B, TBTSL7112030B, TBTSL793050B, are for multiplier reels only, TBTSL7112030 can be used with all reels

TBTSL821220B

TBTSL7112030B

TBTSL7112030

TBTSL793050B

				
2.49m	184cm	2 (SH)*	292g	12-20lb
2.41m	176cm	2 (SH)*	288g	20-30lb
2.41m	176cm	2 (SH)*	285g	20-30lb
2.36m	171cm	2 (SH)*	281g	30-50lb





BeastMaster BX BOAT SLIM

- Slim, ultra strong, Full Carbon blank designed for large fish
- Classic Beastmaster black and gold colour combination
- Special Braid-type guides
- SHIMANO Aluminium extra strong reel seat with double locking rings
- EVA Split Grip with rubber gimbal

BMBXBTSL7612202	2.29m	164cm	2 (SH)*	421g	12-20lb
BMBXBTSL7620302	2.29m	164cm	2 (SH)*	429g	20-30lb
BMBXBTSL7630502	2.29m	164cm	2 (SH)*	467g	30-50lb



VENGEANCE AX BOAT SLIM

- Full Carbon blank has a responsive, moderate action and is an ideal all-round boat rod offering excellent value
- SHIMANO Stainless Steel double leg guides for strength
- Full EVA handle with SHIMANO DPS reel seat
- Rubber cap end for comfortable fish-playing

VAXBTSLS761220	2.29m	164cm	2 (SH)*	259g	12-20lb
VAXBTSLS762030	2.29m	164cm	2 (SH)*	263g	20-30lb
VAXBTSLS763050	2.29m	164cm	2 (SH)*	265g	30-50lb



ROD TECHNOLOGY

SPINNING

TROUT

CATFISH

S.T.C.

SPECIMEN

MATCH & FEEDER

TELESCOPIC

SALTWATER SPINNING

BOAT

SURE



NEW

ALIVIO BX TELE BOAT

- Composite blank
- Short transport length telescopic boat rod with powerful action
- SHIMANO Hardlite guides with corrosion resistant Stainless Steel frames and lined centres suitable for braid and mono lines
- Available in five lengths from compact 1.8m to longer 3.0m lengths for larger boats
- Custom designed SHIMANO reel seat and rubber fighting butt

ALVBXBTTE18H	1.80m	92cm	3	131g	50-150g
ALVBXBTTE21H	2.10m	110cm	3	146g	50-150g
ALVBXBTTE24H	2.40m	115cm	4	218g	50-150g
ALVBXBTTE27H	2.70m	115cm	4	250g	50-150g
ALVBXBTTE30H	3.00m	115cm	4	281g	50-150g



NEW

BeastMaster BOAT QUIVER TE

- Lightweight High Modulus Full Carbon blank with fast action and excellent strength
- SHIMANO DPS reel seat
- Seaguide Hero stainless steel anti-tangle guides
- Special section-lock device enables both models to be fished at different lengths (260-320cm, 300-360cm)
- Supplied with two interchangeable quiver tips
- Rated for fishing with weights of up to 300g

BMCXBTTE2632	2.60-3.30m	124cm	4+ tips	248g	max. 300g
BMCXBTTE3036	3.00-3.60m	134cm	4+ tips	292g	max. 300g



FAST ACTION



NEW

BeastMaster BOAT QUIVER

- Lightweight High Modulus Full Carbon blank with fast action and excellent strength
- SHIMANO DPS reel seat
- Seaguide Hero stainless steel anti-tangle guides
- Supplied with two interchangeable quiver tips
- Rated for fishing with weights of up to 300g
- Removable rubber bulb on base of handle

					
BMAXBT2Q240XH	2.40m	127cm	2+ tips	222g	max. 300g
BMAXBT2Q270XH	2.70m	142cm	2+ tips	254g	max. 300g
BMAXBT2Q300XH	3.00m	156cm	2+ tips	305g	max. 300g





CATANA BOAT QUIVER

- Full Carbon blank
- SHIMANO Stainless Steel Hardlite guides
- DPS reel seat
- Two interchangeable tips for versatile bite detection

CATBT3Q30

3.00m	104cm	3	239g	30-150g



ALIVIO BOAT QUIVER

- Powerful, strong Composite blank with solid white coloured tip for extra bite detection sensitivity
- Designed for various Mediterranean legering and bolentino style of techniques
- SHIMANO Hardlite guides
- SHIMANO DPS reel seat
- Easy clean EVA handle

ALVBTQ150

ALVBTQ180

ALVBTQ210

1.50m	81cm	2	154g	50-150g
1.80m	96cm	2	174g	50-150g
2.10m	111cm	2	192g	50-150g



Sonora BOAT QUIVER

- Strong Composite Carbon + Glass blank with solid orange coloured tip for extra bite detection sensitivity
- Designed for various Mediterranean legering and bolentino style of techniques
- SHIMANO Hardlite guides
- SHIMANO DPS reel seat
- Easy clean EVA handle

SONBTQ150

SONBTQ180

SONBTQ210

1.50m	81cm	2	140g	50-150g
1.80m	96cm	2	166g	50-150g
2.10m	111cm	2	186g	50-150g



NEW MODELS

Beast Master PILK

- High Modulus Full Carbon blank is light, slim and very strong with a moderate fast action designed for pilk lures
- Seaguide Stainless Steel MN guides have immense strength
- SHIMANO DPS reel seat and split EVA handle
- Pacific Bay butt cap for comfortable fish-playing
- Perfect for pilk and softbait fishing for cod, coalfish and small halibut

BMPILK240100200	2.40m	123cm	2	255g	100-200g	
BMPILK240150300	2.40m	123cm	2	257g	150-300g	
BMPILK27070140	2.70m	138cm	2	267g	70-140g	
BMPILK2154095	2.15m	108cm	2	207g	40-95g	NEW
BMPILK2404095	2.40m	123cm	2	224g	40-95g	NEW
BMPILK2704095	2.70m	138cm	2	241g	40-95g	NEW



NEW

VENGEANCE PILK

- Responsive, lightweight Full Carbon blanks, powerful enough to fight the big Northern Europe saltwater species
- Entry-level rod especially designed for pilk and softbait methods
- Strong, corrosion resistant SHIMANO stainless steel guides
- SHIMANO DPS reel seat for solid reel fixation

SVPIK21070140	2.10m	112cm	2	204g	70-140g	
SVPIK240100200	2.40m	126cm	2	226g	100-200g	
SVPIK27070140	2.70m	141cm	2	265g	70-140g	





Beast Master CX INNERGUIDE

- Super strong and powerful High Modulus Full Carbon blank
- Innerguide system has three main advantages. Lightweight and well balanced. Easy to hold straight, rod doesn't want to turn. No chance of knots catching in guides
- Fuji DPS reel seat (MH/H) / Fuji DPS-H reel seat (XH)
- EVA handle

BMCXIG220XH	2.20m	79cm	3	302g	200-450g
BMCXIG220H	2.20m	79cm	3	220g	100-250g
BMCXIG240MH	2.40m	181cm	2	213g	100g



Beast Master BX DOWN RIGGER

- Full Carbon blank + Biofibre creates a strong downrigger
- SHIMANO Stainless Steel Hardlite guides
- SHIMANO designed reel seat
- EVA grips with long front grip for secure handling
- S.D.R. prevents twisting of the blank

BMBXR86M	2.74m	136cm	2	294g	15-30lb



CATANA AX DOWN RIGGER

- Full Carbon blank offers good value for money
- SHIMANO Stainless Steel Hydro Silicium guides
- SHIMANO designed screw down reel seat
- EVA grips with long front grip for secure handling
- Red tip for easy bite detection

CATAXDR210MH	2.10m	106cm	2	320g	15-40lb
CATAXDR240MH	2.40m	120cm	2	339g	15-40lb



SURF RODS

SHIMANO surf rods are available in telescopic and put-together options. In keeping with latest trends many rods now have sensitive tips for increased bite detection and all models offer excellent casting performance.



TELE SURF

- 216 SPEEDMASTER DX TE
- 217 VENGEANCE DX TE · ALIVIO FX TE
- SONORA SURF TE

3-PIECE SURF

- 218 SURF LEADER ULTRA
- ULTEGRA SURF BX TUBULAR / SOLID TIP
- 219 SPEEDMASTER TUBULAR / SOLID TIP
- VENGEANCE TUBULAR / SOLID TIP
- ALIVIO TUBULAR

2-PIECE SURF

- 220 SPEEDMASTER LITE
- NEXAVE LITE / ROUGH GROUND
- VENGEANCE ROUGH GROUND

BEACH LEDGERING

- 221 SPEEDMASTER BEACH

EXTRA FAST ACTION



SpeedMaster DX TELE SURF

- High Modulus Full Carbon + HPC blank with Nanosheet technology produces lighter, stronger blank with increased responsiveness and casting distance
- Extra fast action for increased tip speed when casting
- Fuji Fazlite K-type guides for lightness, strength and saltwater resistance
- Fuji DPS reel seat
- Cast control handle grip for assured handling when casting
- Guide protector for optimal guide protection



NANOSHEET

SMDXSFTE4515	4.50m	155cm	6	430g	150g
SMDXSFTE4517	4.50m	155cm	6	440g	170g
SMDXSFTE4522	4.50m	155cm	6	466g	220g
SMDXSFTE4525	4.50m	155cm	6	488g	250g





VENGENCE DX TELE SURF

- Full Carbon blank with powerful fast action for distance casting
- Corrosion resistant Seaguide Stainless Steel Double Leg guides
- Rubberised painted handle for extra grip in wet conditions
- White tip for good bite indication in low light conditions
- Guide protector for optimal guide protection

VDXSFTE4210
 VDXSFTE4212
 VDXSFTE4215
 VDXSFTE4317
 VDXSFTE4320

VDXSFTE4210	4.20m	154cm	6	480g	100g
VDXSFTE4212	4.20m	154cm	6	510g	120g
VDXSFTE4215	4.20m	154cm	6	510g	150g
VDXSFTE4317	4.30m	154cm	6	518g	170g
VDXSFTE4320	4.30m	155cm	6	525g	200g



ALIVIO FX TELE SURF

- Fast action Full Carbon blank with solid tip for increased sensitivity
- Excellent combination of distance casting performance and value for money
- SHIMANO anti-tangle stainless steel Hardlite guides
- SHIMANO DPS-type reel seat
- Grip paint handle finish for assured grip when casting
- Guide protector for optimal guide protection

ALFXSFTE4010
 ALFXSFTE4215
 ALFXSFTE4217
 ALFXSFTE4220
 ALFXSFTE4225

ALFXSFTE4010	4.00m	152cm	5	540g	100g
ALFXSFTE4215	4.20m	152cm	5	570g	150g
ALFXSFTE4217	4.20m	152cm	5	598g	170g
ALFXSFTE4220	4.20m	152cm	5	616g	200g
ALFXSFTE4225	4.20m	154cm	5	614g	250g



Sonora TELE SURF

- Composite blank is strong, responsive and perfect for the inexperienced surfcaster
- SHIMANO stainless steel Hardlite guides
- SHIMANO DPS-type reel seat
- Grip paint handle finish for assured grip when casting
- Guide protector for optimal guide protection

SONSFTE4215
 SONSFTE4220

SONSFTE4215	4.20m	147cm	5	638g	150g
SONSFTE4220	4.20m	147cm	5	679g	200g

ROD TECHNOLOGY
 SPINNING
 TROUT
 CATFISH
 S.T.C.
 SPECIMEN
 MATCH & FEEDER
 TELESCOPIC
 SALTWATER SPINNING
 BOAT
 SURF



SURF LEADER ULTRA

- The flagship in surf casting rods with unbelievable distance casting ability
- Blank incorporates Spiral X and Hi-Power X technology
- Guides: 450 models Stainless Steel K-Type SiC/
425 models Fuji Stainless Steel Low Rider SiC
- Fuji DPS reel seat
- Supplied with nylon bag



TUBULAR TIP

SFLUSFT425BX	4.25m	150cm	3	552g	225g
SFLUSFT450BX	4.50m	158cm	3	573g	225g

SOLID TIP

SFLUSFS425BX	4.25m	150cm	3	524g	225g
SFLUSFS450BX	4.50m	158cm	3	547g	225g



Solid Tip Models



ULTEGRA TUBULAR / SOLID TIP

- Hi-Power X construction for reduced blank twist and greater rod strength – a true casting machine
- Fuji Low Rider Alconite (425) / Fuji K-Type Alconite guides (450), both lengths have Fuji Stainless Steel SiC tip guide
- Fuji DPS reel seat
- Cast Control Grip
- Two versions: Tubular Tip and Solid Tip
- Nylon bag



TUBULAR TIP

ULTSFT425BXI	4.25m	150cm	3	545g	225g
ULTSFT450BXI	4.50m	158cm	3	583g	225g

SOLID TIP

ULTSFS425BXI	4.25m	150cm	3	537g	225g
ULTSFS450BXI	4.50m	158cm	3	551g	225g



Solid Tip Models





SpeedMaster TUBULAR / SOLID / HYBRID TIP

- High Modulus Full Carbon + HPC with Nanosheet technology produces lighter, stronger blank with increased responsiveness and casting distance
- Extra fast action for increased tip speed when casting
- 3 models available, Tubular Tip (traditional tip action), Solid Tip (ultra sensitive tip action), Hybrid Tip (sensitive tip action)
- Tubular Tip 425/450, Solid Tip 450, Hybrid Tip 450 - Fuji Stainless Steel K Type guides
- Solid Tip 425, Hybrid Tip 425 - Fuji Stainless Steel Low-rider guides



SMSFT425BXG
SMSFT450BXG
SMSFS425BXG
SMSFS450BXG
SMSFH425BXG
SMSFH450BXG

SMSFT425BXG	4.25m	148cm	3	505g	225g
SMSFT450BXG	4.50m	156cm	3	550g	225g
SMSFS425BXG	4.25m	148cm	3	500g	225g
SMSFS450BXG	4.50m	156cm	3	540g	225g
SMSFH425BXG	4.25m	148cm	3	510g	225g
SMSFH450BXG	4.50m	156cm	3	540g	225g



VENGEANCE TUBULAR / SOLID TIP

- Extra strong Full Carbon blanks, capable of fighting big and strong catfish
- Strong DPS reel seat and EVA handle for secure grip
- SHIMANO Hardlite guides
- Rubber bulb butt finish to make fish-playing more comfortable
- Extra strong spinning rods for fishing lures and floats from a boat or the bank

TUBULAR TIP
VSFT425BXX
VSFT450BXX
SOLID TIP
VSFS425BXX
VSFS450BXX

VSFT425BXX	4.25m	148cm	3	586g	225g
VSFT450BXX	4.50m	158cm	3	620g	225g
VSFS425BXX	4.25m	148cm	3	586g	225g
VSFS450BXX	4.50m	158cm	3	620g	225g



ALIVIO TUBULAR

- Fast action Composite blank
- Excellent combination of distance casting performance and value for money
- SHIMANO anti-tangle stainless steel Hardlite guides
- SHIMANO DPS-type reel seat

ALSFT425BX
ALSFT450BX

ALSFT425BX	4.25m	148cm	3	579g	225g
ALSFT450BX	4.50m	158cm	3	665g	225g



SpeedMaster LITE

- High Modulus Full Carbon + HPC blank with Nanosheet technology produces lighter, stronger blank with increased responsiveness and casting distance
- Extra fast action for increased tip speed when casting
- Ultra sensitive solid tip design for excellent bite registration
- Fuji Fazlite K Type anti-tangle guides
- Fuji DPS reel seat
- Cast control handle grip for assured handling when casting



SMSFS130LT

3.96m	201cm	2+tips	425g	120g



NEXAVE LITE / ROUGH GROUND

- High Modulus Full Carbon blank with fast-progressive action for distance casting
- Mid-priced rod with excellent casting abilities and beautiful look
- Seaguide stainless steel guides and SHIMANO plate reel seat on the Lite mode
- SHIMANO Slide 'n grip reel seat on the Rough Ground model
- Tips are either tubular (hollow) for extra distance casting or solid for a good bite detection
- Cloth bag

NEXSF130LT
NEXSF130RD

3.96m	201cm	2	377g	120g
3.96m	220cm	2	690g	225g



VENGEANCE ROUGH GROUND

- Strong and powerful Full Carbon blank ideal for rough ground and large fish surf fishing
- Strong Seaguide stainless steel DL SIC guides
- SHIMANO Sliding Reel Seat for adjustable multiplier reel placement
- Shrink tube handle with Cross Grip Tape

VSFT130RD

3.96m	201cm	2	780g	225g



LIGHT, STRONG, BLANK

SpeedMaster BEACH

- High Modulus Full Carbon + HPC blank with Nanosheet technology produces lighter, stronger blank with increased responsiveness and casting distance
- Extra fast action for increased tip speed when casting
- Ultra sensitive solid tip design for excellent bite registration
- Fuji Fazlite K Type anti-tangle guides
- Fuji DPS reel seat
- Cast control handle grip for assured handling when casting



NANOSHEET

SMSFSB45120
SMSFSBS47150



4.50m

156cm

3

470g

120g

4.70m

163cm

3

520g

150g





LUGGAGE

The ranges of SHIMANO luggage have some of the most radical and ground-breaking designs ever seen in the angling industry.

Just like our rods and reels, great care and attention has been paid to the needs of anglers. Within the ranges, innovative products have been created with the specific aim to meet the needs and aspirations of specialist and specimen anglers alike.

CARP LUGGAGE

224 TRENCH GEAR RANGE

228 TACTICAL GEAR RANGE

232 SYNC GEAR RANGE

235 CARP CARE

238 BEDCHAIRS

GENERAL LUGGAGE

240 SHIMANO LUGGAGE

241 ALL ROUND LUGGAGE

242 LANDING NETS · NET HANDLES



CARP LUGGAGE

BASED AROUND THE ORGANISED COMPACT DESIGN PRINCIPLE, THERE'S A PLACE FOR EVERYTHING FROM INSIDE TO OUT.

TRENCH
GEAR

TACTICAL
GEAR

SYNC
GEAR

TRICAM

Tricam is a unique, carp specific camo design, developed on a new, hard wearing 600 Denier outer material and 210 Denier lining. Introduced specifically for the Trench Gear and Sync Gear luggage range.

ORGANISED
COMPACT
DESIGN

The **Organised Compact Design** system allows the angler to choose from numerous specialised accessory cases that fit, jigsaw-like into one of the many compatible carryalls. This gives the option to change them around for specific venues or the length of time fishing.

The **Organised Compact Design** has now introduced new options for connecting external bags! Webbing loops have been incorporated down the front of most main bags for attaching smaller pouches whilst elastic loops can be found on top of many bags, ideal for holding bite alarms on sticks. Webbing Straps can also be found on larger bags, for attaching food bags and bivy tables.

HD ZIPPERS

HD Zippers can handle the most extreme abuse to ensure SHIMANO luggage lives up to the expectations of the most demanding anglers. HD Zippers have been thoroughly tested for strength and easy of use.

POWER STITCH

Power Stitching is widely used throughout the SHIMANO luggage range. This involves double stitched seams which produce increased strength at all the major stress areas ensuring longevity and reducing the chance of failure.

AERO Quiver
ADVANCE

The **Aero Quiver** system is simply based around an adjustable strap that components can be clipped onto. Like the existing Aero Quiver strap, the new Aero Quiver Advance strap has an improved mesh padding for extra comfort and allows up to 10 different products to be attached, offering countless variations.

TRENCH GEAR

TRENCH GEAR RANGE

SHIMANO's Organised Compact Design system was one of the first modular tackle management luggage systems. Originally based around tackle cases fitting perfectly into larger outer carryalls, the system has now evolved into a complete inside to out system.

The TRIBAL luggage range now comprises Trench outer bags, Sync inner bags and a Trench Barrow which is designed to work perfectly with the all TRIBAL luggage.

All Trench items now feature the TriCam premium 600D outer shell with a contrasting 210D lining material.





COMPACT CARRYALL

- Organised Compact Design takes 4 large or 8 small cases plus large tackle box pocket
- Organised Compact Design base unit and outer fitting
- Barrow fitting



SHTTG01

42cm x 26cm x 40cm



LARGE CARRYALL

- Organised Compact Design takes 6 large or 12 small cases plus large tackle box pocket
- Organised Compact Design base unit and outer fitting
- Barrow fitting



SHTTG02

63cm x 26cm x 40cm



RUCKSACK

- Organised Compact Design takes 4 large or 8 small cases plus large tackle box pocket
- Organised Compact Design base unit and outer fitting
- Barrow fitting



SHTTG05

42cm x 26cm x 40cm



CLOTHING BAG

- Clean and dirty clothes separator
- Wide opening zipper
- Compression straps
- Toiletries pocket
- Heavy duty base



SHTTG26

67cm x 30cm



STALKER BAG

- Organised Compact Design base unit and D ring attachment
- Barrow fitting
- Catapult loop
- 2 mesh side pockets



SHTTG20

42cm x 26cm x 27.5cm



CAMERA BAG

- Accommodates 2 Camera bodies, 12 lenses, 1 tripod
- Extreme internal padding
- Watertight stormflap lid with compression straps for tripod



SHTTG17

44cm x 26cm x 27.5cm



FOOD BAG

- Barrow fitting
- Cutlery pocket with utensils for 2 people
- Thermal centre compartment
- Watertight storm flap lip with compressions straps



SHTTG19

63cm x 26cm x 27.5cm



COOLER BAG

- Organised Compact Design outer fitting
- Barrow fitting
- Watertight storm flap lid with compression straps
- Freezer friendly thermal lining



SHTTG18

42cm x 26cm x 27.5cm



BUZZER BAR BAGS

- Barrow and rucksack fitting
- Extreme internal padding
- External clear pocket and external stick storage



SHTTG15

3 Rod - 45cm x 22cm x 8cm

SHTTG16

4 Rod - 65cm x 22cm x 8cm



ROD HOLDALLS

- Aero Quiver Advanced bag connection system
- Barrow fitting
- Lead pocket and waterproof net pocket
- Zip closure away from reel line
- High durability skid base



SHTTG07
SHTTG08

12ft 3+2 rods - 200cm x 32cm x 25cm
13ft 3+2 rods - 210cm x 32cm x 25cm

PADDED ROD SLEEVES

- Aero Quiver Advanced bag connection system
- Barrow fitting
- Extreme internal padding
- Lead pocket and waterproof net pocket
- Zip closure away from reel line



SHTTG12
SHTTG13

12ft - 195cm x 23cm
13ft - 210cm x 27cm



STINK & STICK BAG

- Aero Quiver Advanced bag connection system
- Barrow fitting
- Watertight welded design
- External storm / marker pole pockets



SHTTG11

23cm x 140cm

TIP PROTECTOR SLING

- Aero Quiver Advanced bag connection system
- Barrow fitting
- Elasticated strap to fit 12ft and 13ft rods
- Padded reel separator for 2 rods



SHTTG10

30cm x 30cm x 24cm

TACTICAL GEAR

TACTICAL GEAR RANGE

Tactical Gear is a more price conscious range of TRIBAL Carp luggage for the angler that prefers the traditional olive/brown colours.

Incorporating many of the premium features found on Trench Gear but with a more focus on design simplicity, Carp care products such as mats come in smaller sizes suitable for UK fisheries and EU Run waters.

ORGANISED
COMPACT
DESIGN

AERO
Clean

zipper

POWER
stitch





NEW

COMPACT CARRYALL

- Organised Compact Design Base Unit
- Organised Compact Design Outer Fitting
- Barrow Fitting - Centre
- Lid Compression Straps
- Internal Mesh Pocket



SHTXL01

42cm x 26cm x 27.5cm



NEW

LARGE CARRYALL

- Organised Compact Design Base Unit
- Organised Compact Design Outer Fitting
- Barrow Fitting - Centre
- Lid Compression Straps
- Internal Mesh Pocket



SHTXL02

63cm x 26cm x 27.5cm



NEW

FULL COMPACT CARRYALL

- Organised Compact Design Base Unit
- Organised Compact Design Outer Fitting
- Barrow Fitting - Centre
- Fully Loaded With 4 X Small Case, 2 X Large Case



SHTXL04

63cm x 26cm x 27.5cm



NEW

RUCKSACK

- Organised Compact Design Base Unit
- Organised Compact Design Outer Fitting
- Barrow Fitting - Centre
- Lid Compression Straps
- Internal Mesh Pocket



SHTXL05

42cm x 26cm x 27.5cm



NEW

COOLER BAIT BAG

- Thermal Centre Compartment
- Barrow Fitting - Centre



SHTXL21

31.5cm x 26cm x 27.5cm



NEW

BREW KIT & SNACK BAG

- Thermal Centre Compartment perfect for bottled milk
- Barrow Fitting - Centre
- Spoon Loop



SHTXL22

31.5cm x 26cm x 27.5cm



NEW

COMPACT FOOD BAG

- Cutlery Pocket With Utensils For 2 People
- Thermal Centre Compartment
- Barrow Fitting - Centre



SHTXL23

42cm x 26cm x 27.5cm



NEW

BUZZER BAR BAG

- Barrow - Front/Rear & Rucksack Fitting
- Internal Padding
- External Clear Receiver Pocket
- External Stick Storage On Back
- 2 Internal Accessory Pockets



SHTXL24

46cm x 22cm x 40cm



NEW

TIP TOP ROD BANDS

- Aero Quiver Basic Bag Connection System
- Barrow Fitting - Sides



SHTXL20

Extends to fit most models



12ft

13ft



10ft

3/4

12ft

13ft

NEW**ROD HOLDALLS**

- Aero Quiver Basic Bag Connection System
- Lead Pocket, Net Pocket
- Barrow Fitting - Sides
- Zip Closure Away From Reel Line



SHTXL11	12ft 2 rods - 200cm x 33cm x 20cm
SHTXL12	12ft 3 rods - 200cm x 33cm x 25cm
SHTXL13	13ft 3 rods - 210cm x 33cm x 25cm
SHTXL14	13ft 4 rods - 210cm x 33cm x 30cm

NEW**PADDED ROD SLEEVES**

- Aero Quiver Basic Bag Connection System
- Lead Pocket
- Barrow Fitting - Sides
- Part Padded For Protection



SHTXL16	10ft - 167cm x 28cm
SHTXL17	3/4 - 182cm x 14cm x 25cm
SHTXL18	12ft - 195cm x 27cm
SHTXL19	13ft - 210cm x 27cm

NEW

TX LITE 2+1 ROD BAG

- Aero Quiver Basic Bag Connection System
- Lead Pocket & Net Pocket
- Barrow Fitting - Sides
- Zip Closure Away From Reel Line
- Rod Hood



SHTXL32 | 110cm x 62cm



NEW

BIVVY BAG

- Aero Quiver Basic Bag Connection System
- External Peg Pocket
- Barrow Fitting - Sides
- External Storm Pole Pockets
- Standard: Fits 1 Man and Smaller Bivvies



SHTXL25 | ø20cm x 135cm (Standard)

NEW

BROLLY BAG

- Aero Quiver Basic Bag Connection System
- External Peg Pocket
- Barrow Fitting - Sides
- External Storm Pole Pockets



SHTXL08 | ø30cm x 190cm

NEW

STINK BAG

- Aero Quiver Basic Bag Connection System
- Watertight Welded Design
- Barrow Fitting - Sides



SHTXL09 | 145cm x 23cm

SYNC GEAR

SYNC GEAR RANGE

Designed to fit perfectly into Trench Gear luggage, Sync Gear is the ideal solution for storing smaller items of tackle in an organised way.





SMALL ACCESSORY CASE

- Organised Compact Design internal bag
- Fold down internal separators
- Padded lining



SHTSC01

27cm x 12.5cm x 10cm



LARGE ACCESSORY CASE

- Organised Compact Design internal bag
- Fold down internal separators
- Padded lining



SHTSC02

27cm x 25cm x 10cm



XL ACCESSORY CASE

- Organised Compact Design internal bag
- Fold down internal separators
- Padded lining



SHTSC03

27cm x 25cm x 20cm



MAGNETIC SECURITY CASE

- Organised Compact Design internal bag
- Fold down internal separators
- Padded lining
- Strong magnetic bivy wall fitting



FOOD SET

- Organised Compact Design internal bag
- Fully loaded kitchen ware for 2 people
- Additional space for stove and gas



SHTSC05

27cm x 12.5cm x 10cm



RIG & BITS CASE

- Organised Compact Design internal bag
- Fold down internal separators
- Internal storage pockets
- 3 small terminal tackle boxes included



SHTSC11

27cm x 12.5cm x 10cm



LEAD & BITS CASE

- Organised Compact Design internal bag
- 2 Internal zippered lead pockets
- Credit card sleeves for accessories
- Spool storage pockets



SHTSC10

27cm x 12.5cm x 10cm



SCALE CASE

- Organised Compact Design internal bag
- Extreme internal padding
- Internal collapsible water bucket supplied
- Weigh bar internal pocket



SHTSC13

27cm x 25cm x 10cm



SPOOL CASE

- Organised Compact Design internal bag
- Rigid protective body
- 4 protective spool socks



SHTSC14

27cm x ø10cm



HOOKBAIT CASE

- Organised Compact Design, interne tas
- Inclusief 6 x smalle aasbakjes



SHTSC08

27cm x 12.5cm x 10cm



PVA CASE

- Organised Compact Design internal bag
- Funnel web storage pocket
- Elasticated tool loops
- Watertight PVA bag storage box



SHTSC12

27cm x 12.5cm x 10cm



SMALL POUCH

- Organised Compact Design external bag
- Detachable strap



SHTSC18

14cm x 20cm



BAITING CADDY

- Organised Compact Design internal bag
- Concealed waist band
- Freezer friendly thermal lining
- Internal wings limiting bait spillage



SHTSC20

27cm x 12.5cm x 10cm



5KG / 10KG AIRDRY BAG

- Barrow fitting
- Drop out airmesh
- Airdry and bait zipper access



SHTSC21

5KG - 36cm x 36cm

SHTSC22

10KG - 55cm x 40cm



BAIT BUCKET

- Square bucket with Tricam pattern
- Keeps all you gear dry and your boilies fresh
- Barrow fitting - centre



SHTSC35

26cm x 29cm x 29.5cm



BIVVY TABLE

- Barrow fitting
- Twist lock adjustable legs
- Folding legs
- Supplied with a bag



SHTSC15

50cm x 30cm x 21cm

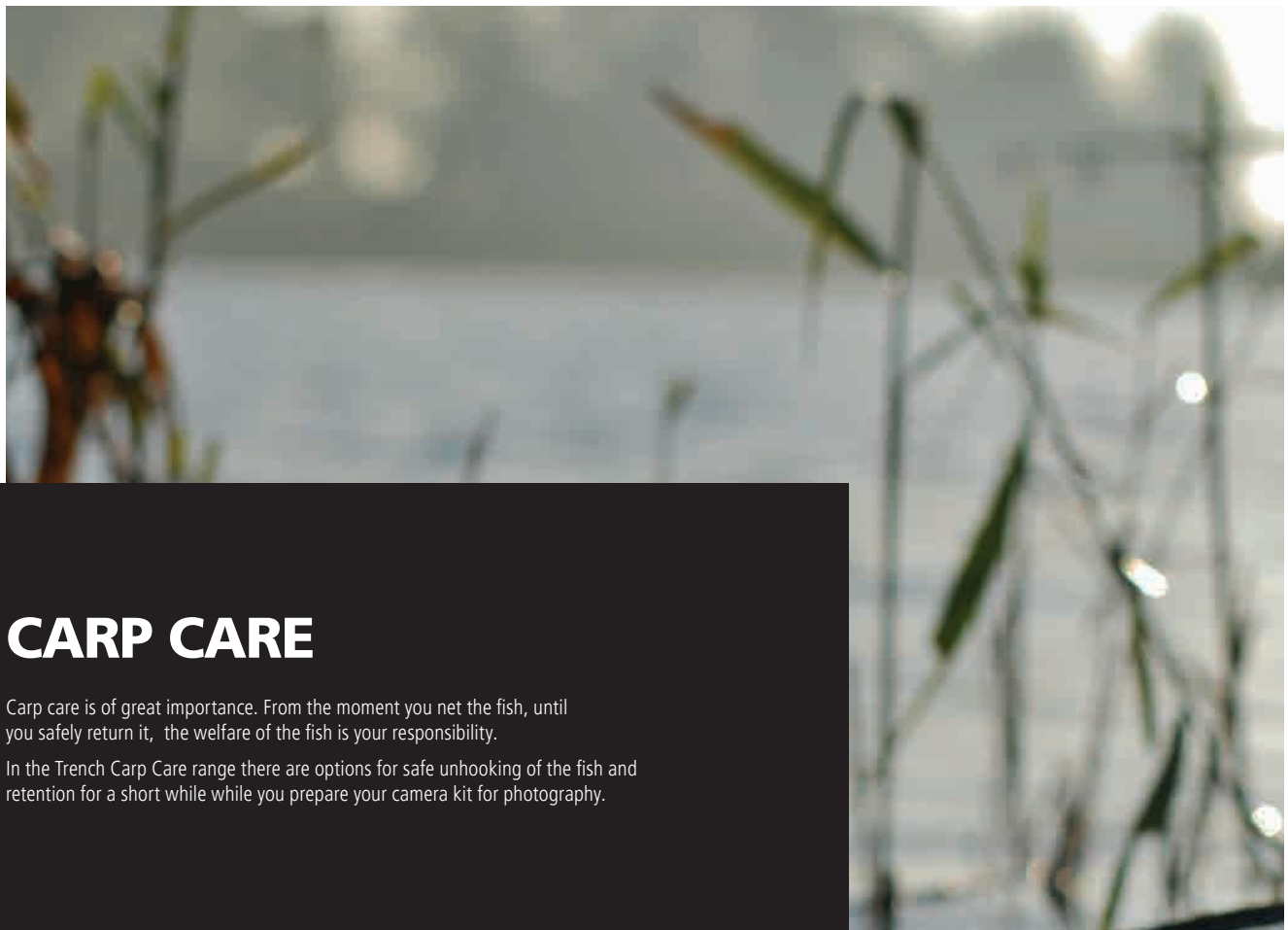

CARP CARE

Carp care is of great importance. From the moment you net the fish, until you safely return it, the welfare of the fish is your responsibility.

In the Trench Carp Care range there are options for safe unhooking of the fish and retention for a short while while you prepare your camera kit for photography.



CARP CARE

TRENCH
GEAR



CALMING RECOVERY SLING

- Aero Quiver Advanced bag connection system
- Barrow fitting
- Watertight bag
- Fish calming retention sacking
- Cord, float and bankstick attachment
- Hi-vis reflective tape on floats

SHTTG21

120cm x 60cm



PROTECTION MAT

- Aero Quiver Advanced bag connection system
- Barrow fitting
- Quick transport compression clips
- Rigid sides and extensive padding
- Stay wet fish-safe mesh cover

SHTTG22

125cm x 80cm x 22cm (Euro)

SHTTG23

110cm x 76cm x 22cm (Regular)



EURO STRESS FREE MAT

- Aero Quiver Advanced attachment
- Quick fold design for instant setup/breakdown time
- Built-in bag
- Padded sides for fish safety
- End supports for easy use with retainers

SHTTG24

120cm x 80cm x 38cm



EURO CRADLE

- Aero Quiver Advanced attachment
- Quick fold design for instant setup/breakdown time
- Curved easy pick up and photo friendly frame
- Stay wet, summer safe mesh cover
- Padded bars for fish safety

SHTTG25

120cm x 80cm



NEW

CALMING RECOVERY SLING

- Aero Quiver Basic Bag Connection System
- Watertight Welded Design Containment Bag
- Barrow Fitting - Sides
- Full Water Circulation Design
- Cord, Float And Bankstick Fitting



SHTXL26

115cm x 60cm



NEW

FLAT MAT

- Aero Quiver Basic Bag Connection System
- Watertight Built In Containment
- Barrow Fitting - Sides



SHTXL27

110cm x 76cm



NEW

EURO STRESS FREE MAT

- Aero Quiver Basic Bag Connection System
- Quick Fold Design For Instant Setup/Breakdown Time
- Barrow Fitting - Centre
- Built In Bag
- Padded Sides For Fish Safety



SHTXL30

110cm x 62cm x 25cm



NEW

EURO CRADLE

- Aero Quiver Basic Bag Connection System
- Quick Fold Design For Instant Setup/Breakdown Time
- Barrow Fitting - Centre
- Curved Easy Pickup And Photo Friendly Frame
- Stay Wet Summer Safe Mesh Cover



SHTXL31

110cm x 62cm x 25cm



NEW

WEIGH MAT

- Aero Quiver Basic Bag Connection System
- Tacklebox Pocket
- Barrow Fitting - Sides
- Zip Up Side For Weighing



SHTXL33

87cm x 76cm x 35cm



FLAT-Pak - utilises different length hinges that allows each end of the bed to fold down square. This offers a square shape when folded which stands up and goes in the car better, but more importantly lowers the amount of pressure on the fitted Sleeping bag and pillow so that they don't become compacted over time and ultimately less effective in the cold.



HEAT-Trap - incorporates an oversized 10cm over padded inner baffle that stops warm air from leaving through the zip and cold air from coming inside, so that all the warmth generated inside the bag, stays in the bag.



EAZI-Glide - zips incorporate full length strips of 5cm nylon webbing on the inside of the zips that are stitched at both edges and offer almost zero chance of catching on the inner duvet material when open of closing, so takes in the night mean that you will have confidence that you can get to your rods instantly. Used in conjunction with SHIMANO ultra durable Heavy Duty(HD) Zippers.



SWING-Lok Legs - are designed to make the set up of the bed much easier. End support legs do not fold lengthways, instead they fold at a 90°, to the side which means that they can be swung open and locked in place as the bed is assembled or with a single hand.



MULTI-Comfort - Special thought has gone into the materials for each inner and outer parts of the duvets. Fleece in areas around the head on upper bottom for warmth but smooth silky smooth material around legs and back for easy movement and grabbing from clothing. Trench gear beds have a second duvet that can either be removed or slept under in the summer months.



4-SEASON - Trench Gear beds are true 4 season beds off the shelf. Incorporating 2 layer 240gsm Grade A Hollow Fibre that is thick, light and ensures you are toasty even in temperatures as low as minus 10° C.



NEW

TRENCH BEDCHAIR SYSTEM

- Super Light Mag Frame
- 4-Season (-10) Bag
- Lay-Flat Design For Comfort
- Flat Pack For Easy Transport
- Swing Lock Leg For Easy Erection
- Foot Cover For Protection
- Multi-Layer Comfort
- Water-Shell Protection
- Eazi-Glide Zips
- Heat-Trap Baffle
- Pillow-Lok

NEW

TACTICAL BEDCHAIR SYSTEM

- Lay-Flat Design For Comfort
- Flat Pack For Easy Transport
- Swing Lock Leg For Easy Erection
- Foot Cover For Protection
- Multi-Layer Comfort
- Eazi-Glide Zips
- Heat-Trap Baffle
- Pillow-Lok

**TRENCH
GEAR**
**TACTICAL
GEAR**

ONLY AVAILABLE IN THE UK

SHTTGBCS01	Trench Gear Mag Bedchair System
SHTTGBCS02	Trench Gear Mag Bedchair System Wide
SHTXLBCS01	Tactical Bedchair System
SHTXLBCS02	Tactical Bedchair System Wide



MAG-Frame - beds incorporate parts of the frame that are made from a special type of Magnesium alloy, this vastly reduces weight being 37% lighter than Aluminium, however retains strength allowing these beds to be much more manageable to transport and assemble.



PILLOW-Lok - offers a 2 point locking system for our pillows. 2 toggles at the top and 2 loops under the head area of the bed for straps to pass through. This stops the pillow riding up and off the top of the bed whilst you are asleep, giving you a comfortable nights rest.



WATER-Shell - is a special lightweight waterproof outer skin that is wipe clean that will offer resistance from light rain and frost to the beds cover and finished in the TRI-CAM pattern.



LEG-Lok - is a specially located webbing clip that holds the main legs tight and secure to the body of the bed so legs can be secured for handling and transport. The Bed frame also has closing straps which can be done first meaning pack away is extremely simple and quick even while inside the bivvy.



LAY-Flat - is the hinged frame design in which support bars butt against each other, this gives a perfectly flat bed for extreme comfort, which equals to a much better sleep and a more evenly spaced fold away whilst keeping strength and durability.



FOOT-Covers - are a small attention to detail and are tough covers designed to fit over the end support leg feet to ensure no dirt or water is transferred to the duvet or bed while in transit.



LOK & Load Legs - incorporate a durable push button spring loaded leg mechanism. This makes extending legs while in the bivvy to level as simple as pushing a button.



GROUNDBAIT BOWL

- Collapsible groundbait bowl
- Ideal for storing bait or taking groundbait to the bank already mixed
- Semi rigid design for ease of use
- Zippered lid allows easy access
- Carry handles

SHPVC04

20cm x 32cm



NET BAGS

- Watertight net bag ideal for transporting wet keepnets and landing net heads
- Soft high quality waterproof material
- Folds flat and can stored away on windy days
- Rigid wire opening for easy loading of nets
- Adjustable shoulder strap and padded carry handles

SHPVC01

Double - 60cm x 60cm x 15cm

SHPVC02

Triple - 60cm x 60cm x 20cm



LURE CASES

- Lures can be stored individually or in the their case in separate compartments
- Quick and easy access to all lures
- Made from easy-clean PVC with a moulded polyester lid
- Can be carried on shoulder or waist

SHLCH01A

Medium - 16cm x 19cm x 9cm

SHLCH02

Large - 19cm x 27cm x 15cm



RIG WALLET

- A stylish rig wallet comprising eight secure fastening vinyl rig sleeves
- Can be attached to other luggage via an integral clip
- Perfect for shaped 'Chod' rig storage
- Easy to clean outer material

SHLCH06

13cm x 13cm x 3cm



REEL CASE

- A stylish reel case ideal for storing and protecting spinning reels
- Double zipped top panel
- Carbon-look easy to clean outer material

SHLCH03

Medium - 12cm x 16cm x 8cm

SHLCH04

Large - 13cm x 20cm x 11cm



DURA DELUXE CARRYALL

- Roomy double zippered main compartment
- 50cm wide front pocket complete with insert EVA net bag
- Two extra large side pockets
- Supplied with an insert EVA Net bag
- Multiple ALL-ROUND Accessory case fit inside
- Sliding shoulder pad and carry handles

SHALLR01

52cm x 37cm x 43cm



BAIT & BITS BAG

- Compact carryall ideal for all disciplines
- Single large zippered main compartment
- Thermal lined main compartment
- Front zippered pocket for hookbaits and additives
- Tough meshed back pocket
- Sliding shoulder pad and carry handles

SHALLR03

38cm x 32cm x 31cm



TACKLE BAG

- Two tough mesh pockets, each side
- Front zippered pocket for smaller items
- Sliding shoulder pad and carry handles

SHALLR05

33cm x 26cm x 22cm



ROD SLEEVES

- Double rod & reel fitting (SHALLR07)
- Triple rod & reel fitting (SHALLR08)
- Full length side pocket
- Stiff protective lining
- Sliding shoulder pad and carry handle

SHALLR07

170cm x 22cm x 22cm

SHALLR08

170cm x 22cm x 22cm



DOUBLE ROD + HOLDALL

- Soft padded body double compartment ready rod holdall
- Side pocket for umbrella and net handle
- Sliding shoulder pad and carry handle

SHALLR11

175cm x 24cm x 26cm



ROD BANDS

- Two pieces per pack
- Unique design that incorporates a pocket for storing a method feeder
- Stretchy neoprene for easy tightening

SHALLR06



STRESS FREE UMBRELLA

- (50in) Nylon UMBERLLA
- Flat to floor back
- Robust 90° angle lock
- 250cm Opened Diameter

SHALLR12

250cm

PVC CHEST WADERS

- Waterproof PVC chest waders
- High wear durability
- Adjustable webbing braces with quick release plastic buckles (chest waders)
- Extra wide welded seams
- PVC boot with cleated sole
- Includes repair kit

SHPVCW

| Sizes: 40 / 41 / 42 / 43 / 44 / 45 / 46 / 47



TRIBAL LANDING NET

- 42ins triangular net with 1.8m reinforced carbon pole
- Fish friendly deep soft mesh with a flat base
- Super strong metal spreader block with isotope insert
- Stink bag supplied

TRBLN180

| 180cm



BEASTMASTER LANDING NET POLE

- Extra-strong landing net handles suited to commercial fisheries
- Threaded cap offers extra strength

BMAXLNP300

| 3.0m

BMAXLNP450

| 4.5m



Aero Pro Light



Aero Pro Power



Aero Pro Multi

NEW

AERO PRO LANDING NET HANDLES

- Designed to accompany the Aero rod range
- Available in different lengths and stiffness of handles ensuring competitive coarse anglers can overcome all situations
- An ultra-light 'Light' version, perfect for natural fishing
- An ultra stiff 'Power' version, perfect for handling bigger fish
- Clever section tapers push balance to the butt end making the handle feel lighter
- A multi extension is available to fit all versions

AEPROLNH30L

| Net Handle Light (300cm)

AEPROLNH30P

| Net Handle Power (300cm)

AEPROMLNH3045

| Net Handle Multi inc. ext (250-450cm)

AEPROLNHEXT

| Handle Extension (50cm)



LINE

As one of the worlds foremost reel manufactures we know how much punishment fishing lines can take. We have spent many years developing the lines in our range to cope with a wide variety of angling situations from saltwater fishing to snag-infested lakes. Whatever your angling passion, or budget. You can be sure they'll be something here for you.

MONO

- 244 ALL ROUND MONO
- 245 SPECIAL USE AERO MONO
- 246 TROUT COMPETITION MONO
- YASEI PREDATOR MONO

- 247 SPINNING MONO
- SPECIMEN MONO

- 248 SALTWATER MONO

BRAID

- 250 KAIRIKI BRAID
- 251 POWER PRO BRAID





TECHNIUM

- Triple-core mono specifically designed for increased casting performance
- Extremely low stretch of approximately 12% gives far superior bite detection
- Sinks very rapidly and settles on the contours of the lake bed
- Renowned for its strength and suppleness
- Dark colour blends perfectly to silty bottoms

		Spool	0.16mm 2.60kg	0.18mm 3.20kg	0.20mm 3.80kg	0.22mm 5.00kg	0.25mm 6.10kg	0.28mm 7.50kg	0.30mm 8.50kg	0.35mm 11.50kg	0.40mm 14.00kg
TEC200	200m		✓	✓	✓	✓	✓	✓	✓		
TEC300	300m Premium					✓	✓	✓	✓	✓	
TEC(M)(MM)	Premium							✓(650m)	✓(650m)	✓(600m)	✓(450m)
TECQP	Q.Pound Premium		✓(2990m)	✓(2480m)	✓(1920m)	✓(1530m)	✓(1250m)	✓(1100m)	✓(790m)	✓(620m)	✓
TECBLK5000	5000m					✓	✓	✓	✓	✓	✓



TECHNIUM INVISITEC

- A monofilament that is practically invisible in the water, helping it to blend into any lake bed
- Triple layer construction offers low stretch properties for increased bite detection
- Outstanding strength
- Superb casting properties
- Sinks quickly and stays on the bottom

		Spool	0.14mm 2.20kg	0.16mm 2.70kg	0.18mm 3.30kg	0.20mm 4.20kg	0.22mm 5.30kg
TECINV300	300m			✓	✓	✓	✓
TECINVQPPB	Q.Pound (Prem)				✓(2990m)	✓(2480m)	✓(1920m)
		Spool	0.25mm 6.70kg	0.28mm 7.70kg	0.30mm 9.00kg	0.35mm 12.00kg	0.40mm 15.00kg
TECINV300	300m		✓	✓	✓	✓	✓
TECINVQPPB	Q.Pound (Prem)		✓(1371m)	✓(1330m)	✓(1100m)	✓(790m)	✓(620m)
TECINVLK5000	5000m		✓	✓	✓	✓	✓



EXAGE

- Good value all round monofilament mainline
- Exceptional knot strength
- Perfect for both freshwater and saltwater
- Made in Japan

		Spool	0.12mm 1.30kg	0.14mm 1.80kg	0.16mm 2.30kg	0.18mm 2.90kg	0.20mm 3.40kg	0.22mm 4.40kg
EXG150	150m		✓	✓	✓	✓	✓	✓
EXG300	300m					✓	✓	✓
EXG1000	1000m					✓	✓	✓
EXG5000	5000m						✓	
		Spool	0.25mm 5.50kg	0.30mm 7.50kg	0.35mm 10.40kg	0.40mm 12.90kg	0.50mm 19.00kg	
EXG150	150m		✓	✓	✓	✓		
EXG300	300m		✓	✓	✓	✓		
EXG1000	1000m		✓	✓	✓	✓	✓	
EXG5000	5000m		✓	✓	✓	✓		

NEW

AERO FLOAT

- High quality mono designed for float fishing
- Semi-buoyant enables the line to be used on or just under the surface
- Very soft for effortless casting and float control
- Low stretch for direct contact and faster striking
- 150m length spools for 'one-shot' reel filling



	Spool	0.137mm 1.69kg	0.155mm 2.14kg	0.173mm 2.65kg	0.192mm 3.20kg
AERFL150	150m	✓	✓	✓	✓

NEW

AERO SLICK SILK

- Designed for pole rigs and hooklengths
- Excellent linear and knot strength
- Ultra soft with silky smooth surface for very natural bait presentation
- Low visibility clear colour for minimal fish detection
- Wide range of diameters on 100 metre spools



	Spool	0.076mm 0.57kg	0.086mm 0.74kg	0.096mm 0.914kg	0.104mm 1.08kg	0.114mm 1.27kg	0.123mm 1.48kg
AERSSRH100	100m	✓	✓	✓	✓	✓	✓
	Spool	0.133mm 1.69kg	0.152mm 2.23kg	0.172mm 2.79kg	0.190mm 3.45kg	0.210mm 4.13kg	0.240mm 5.28kg
AERSSRH100	100m	✓	✓	✓	✓	✓	✓

NEW

AERO SILK SHOCK FLUOROCARBON

- 100% fluorocarbon pole rig and hooklength line
- Almost invisible under water for improved bait presentation
- Fast sinking with low memory for perfect pole float control
- One of the best feeder fishing hooklength materials available
- Exceptional knot strength and resilience to damage



	Spool	0.080mm 0.52kg	0.104mm 1.10kg	0.114mm 1.29kg	0.132mm 1.72kg	0.158mm 2.46kg
AERSSFRH50	50m	✓	✓	✓	✓	✓
	Spool	0.179mm 3.01kg	0.195mm 3.26kg	0.220mm 3.88kg	0.255mm 5.35kg	
AERSSFRH50	50m	✓	✓	✓	✓	



NEW

Trout **COMPETITION** FLUOROCARBON

- 100% fluorocarbon leader for trout fishing
- Very robust and abrasion resistant to reduce damage from sharp teeth
- Low visibility under water to increase takes especially in clear water
- Soft and supple for good knotting and improved bait presentation
- Thin diameters for finesse presentation

	Spool	0.120mm 1.05kg	0.140mm 1.29kg	0.1665mm 2.05kg
TROUTCF50	50m	✓	✓	✓



NEW

Trout **COMPETITION** MONO

- Designed for trout competition and commercial fishing
- Soft and supple characteristics for easy, accurate casting
- Low stretch for direct contact and faster striking
- Red colour for easy sighting on the surface but subdued colour under water
- Good linear and knot strength

	Spool	0.12mm 1.29kg	0.14mm 1.70kg	0.16mm 2.16kg	0.18mm 2.67kg	0.20mm 3.27kg	0.22mm 4.05kg
TROUTCM150	150m	✓	✓	✓	✓	✓	✓



NEW

YASEI PREDATOR

- 100% fluorocarbon predator leader
- Very robust and extremely abrasion resistant
- Low visibility under water to increase takes especially in clear water
- Available in thin diameters for finesse and small lure fishing
- Soft and supple for good knotting and improved lure presentation

	Spool	0.90mm 40.19kg				0.100mm 45.86kg			
YASPFL10	10m	✓	✓	✓	✓	✓	✓	✓	✓
	Spool	0.18mm 2.93kg	0.20mm 3.05kg	0.22mm 3.59kg	0.25mm 5.06kg	0.28mm 6.32kg	0.30mm 7.17kg	0.35mm 8.08kg	0.40mm 11.93kg
YASPFL50	50m	✓	✓	✓	✓	✓	✓	✓	✓

CATANA SPINNING

- Versatile spinning mono
- Excellent value for money
- Low memory with good knot strength
- Japanese packaging style
- Made in Japan



Spool		0.16mm	0.18mm	0.20mm	0.22mm	0.25mm	0.28mm	0.30mm	0.35mm
		2.90kg	3.50kg	4.20kg	5.40kg	6.70kg	8.20kg	9.20kg	12.50kg
CATSPG150	150m	✓	✓	✓	✓	✓	✓	✓	✓

TECHNIUM TRIBAL

- A robust monofilament line with a camouflage finish
- Low stretch for increased bite detection
- High strength and suppleness
- Green camouflage finish is less detectable to wary fish
- An outstanding line for fishing weedy waters



Spool		0.28mm	0.30mm	0.35mm	0.40mm
		7.50kg	8.50kg	11.50kg	14.00kg
TECTRQP	Q.Pound (Premium)	✓ (1250m)	✓ (1100m)	✓ (790m)	✓ (620m)
TECTRBLK5000	5000m		✓	✓	

TRIBAL FLUOROCARBON

- A very supple/ flexible line for excellent castability
- Very fast sinking
- Clear coloured for low visibility
- Excellent abrasion resistance
- Made in Japan



Spool		0.32mm	0.35mm
		14 lbs	16 lbs
TRFCF1000	1000m	✓	✓
TRFCF250	250m	✓	✓



NEW

SpeedMaster

- Superior casting performance for distance and accuracy
- Low stretch transfers more power into the lead on the cast
- Extremely abrasion resistance, protecting the line against sharp obstructions underwater
- High breaking strength
- Clear colour

	Bobine	0.18mm 3.05kg	0.20mm 3.69kg	0.22mm 4.38kg	0.25mm 5.54kg	0.28mm 6.81kg	0.30mm 7.95kg	0.35mm 10.21kg
SMSM	300m	✓	✓	✓	✓	✓	✓	✓
SMSM	1200m	✓	✓	✓	✓	✓	✓	✓



NEW COLOUR

SpeedMaster TAPERED SURF LEADER

- High abrasion resistance and high knot strength
- Highly visible colour
- Super smooth finish ensures precision casting at long distances
- 10 leaders each of 15 meter
- Good alternative for the Tapered Surf line

	Spool	0.18-0.50mm (2.20-12.00kg)	0.20-0.57mm (2.70-17.00kg)	0.23-0.57mm (3.60-17.00kg)	0.26-0.57mm (4.60-17.00kg)	0.33-0.57mm (7.20-17.00kg)
SMTLSF	10 x 15m Orange	✓	✓	✓	✓	✓
SMTLSF	10 x 15m Clear	✓	✓	✓	✓	✓



SpeedMaster TAPERED SURF LINE

- No more knots needed when tying shock leaders
- Less knots generate less friction and improve casting
- Made in Japan

	Spool	0.235-0.57mm (3.50-16.70kg)	0.260-0.57mm (4.40-16.70kg)	0.330-0.57mm (6.90-16.70kg)
SMTSF220	220m	✓	✓	✓

TIAGRA HYPER

- TIAGRA HYPER TROLLING meets IGFA rules, means it is suitable for usage in official tournaments
- Line with low memory for preventing knots
- Special colours which will be almost invisible in the ocean waters
- Incredible abrasion resistant, built to last during fast runs of a big fish
- Reasonable elongation to absorb shocks during the take and the fight
- Very high knot strength

	Spool	0.42mm 20lb / 10kg	0.52mm 30lb / 15kg	0.68mm 50lb / 24kg	0.86mm 80lb / 37kg
TGHP0	1000m	✓	✓	✓	✓



TIAGRA TROLLING

- Line with low memory for preventing knots
- Special colours which will be almost invisible in the ocean waters
- Incredible abrasion resistant, built to last during fast runs of a big fish
- Reasonable elongation to absorb shocks during the take and the fight
- Very high knot strength
- Made in Japan

	Spool	0.45mm 20lb / 9kg	0.55mm 30lb / 13kg	0.70mm 50lb / 22.7kg	0.90mm 80lb / 36.3kg
TGRG0	1000m	✓	✓	✓	✓



OCEA

- High breaking strength compared to it's diameter
- Clear coloured
- Refractive index is close to that of water, therefore nearly invisible for fish
- Soft Fluoro core for knot strength, hard outer shell for abrasion resistance, fluorine coating for smooth surface finish
- Doesn't absorb water
- Made in Japan

	Spool	0.38mm 20lb / 9.1kg	0.48mm 30lb / 13.6kg	0.58mm 40lb / 18.1kg	0.63mm 50lb / 22.7kg
59WCL036L1	50m	✓	✓	✓	✓
	Spool	0.71mm 60lb / 27.2kg	0.82mm 80lb / 36.3kg	0.97mm 100lb / 45.4kg	
59WCL036L1	50m	✓	✓	✓	✓





極力 KAIRIKI 8

- Advanced 8 carrier Japanese PE braid, manufactured with S-EBT (SHIMANO Enhanced Body Technology)
- Produces tighter, smoother and rounder line for longer casts
- Selecting newer and softer PE material gives a supple feeling that the pro demands
- Available in 4 colours: High visibility Mantis Green, Yellow, Multi Coloured and low visibility Steel Grey
- 150m, 300m and 3000m bulk spools are available in up to 12 different diameters, from $\varnothing 0,06\text{mm}$ to $\varnothing 0,42\text{mm}$

Spool			0.06mm 5.3kg	0.10mm 6.5kg	0.13mm 8.2kg	0.16mm 10.3kg	0.19mm 12kg	0.20mm 17.1kg	0.215mm 20.8kg	0.23mm 22.5kg	0.28mm 29.3kg	0.315mm 33.5kg	0.35mm 39.5kg	0.42mm 46.7kg
59WPLA58R	150m	Mantis Green	✓ (00)	✓ (01)	✓ (02)	✓ (03)	✓ (04)	✓ (05)	✓ (06)	✓ (07)	✓ (08)	✓ (09)	✓ (0A)	✓ (0B)
		Steel Grey	✓ (10)	✓ (11)	✓ (12)	✓ (13)	✓ (14)	✓ (15)	✓ (16)	✓ (17)	✓ (18)	✓ (19)	✓ (1A)	✓ (1B)
		Yellow	✓ (30)	✓ (31)	✓ (32)	✓ (33)	✓ (34)	✓ (35)	✓ (36)	✓ (37)	✓ (38)			
59WPLA68R	300m	Mantis Green	✓ (00)	✓ (01)	✓ (02)	✓ (03)	✓ (04)	✓ (05)	✓ (06)	✓ (07)	✓ (08)	✓ (09)	✓ (0A)	✓ (0B)
		Steel Grey	✓ (10)	✓ (11)	✓ (12)	✓ (13)	✓ (14)	✓ (15)	✓ (16)	✓ (17)	✓ (18)			
		Yellow	✓ (30)	✓ (31)	✓ (32)	✓ (33)	✓ (34)	✓ (35)	✓ (36)	✓ (37)	✓ (38)			
		Multi	✓ (20)	✓ (21)	✓ (22)	✓ (23)	✓ (24)	✓ (25)	✓ (26)	✓ (27)	✓ (28)	✓ (29)	✓ (2A)	✓ (2B)
59WPLM98S	3000m	Mantis Green		✓ (1A)	✓ (1B)	✓ (1C)	✓ (1D)	✓ (1F)	✓ (1G)	✓ (1H)	✓ (1J)	✓ (1K)	✓ (1L)	✓ (1M)
		Steel Grey		✓ (2A)	✓ (2B)	✓ (2C)	✓ (2D)	✓ (2F)	✓ (2G)	✓ (2H)	✓ (2J)	✓ (2K)	✓ (2L)	✓ (2M)
		Yellow		✓ (3A)	✓ (3B)	✓ (3C)	✓ (3D)	✓ (3F)	✓ (3G)	✓ (3H)	✓ (3J)	✓ (3K)	✓ (3L)	
		Multi		✓ (4A)	✓ (4B)	✓ (4C)	✓ (4D)		✓ (4G)	✓ (4H)	✓ (4J)	✓ (4K)	✓ (4L)	



NEW

極力 KAIRIKI 4

- High quality Japanese 4 carrier braid at a very economical price (50% less than 8 strand braids)
- VT construction produces a tight weave, smooth finish for longer casts and less noise
- Reduced stretch factor of less than 3% for increased sensitivity
- Four colours available - Mantis Green, Steel Grey, Hi-Vis Orange and Multi Colour (base colour changes every 10m) to suit different techniques

Spool			0.06mm 4.4kg	0.10mm 6.8kg	0.13mm 7.4kg	0.16mm 8.1kg	0.19mm 11.6kg	0.20mm 13.8kg	0.215mm 16.7kg	0.23mm 18.6kg	0.28mm 26kg	0.315mm 29.9kg
LDM54TE	150m	Mantis Green (G)	✓	✓	✓	✓	✓	✓	✓	✓	✓	✓
		Steel Grey (S)	✓	✓	✓	✓	✓	✓	✓	✓	✓	✓
		Hi-vis Orange (H)	✓	✓	✓	✓	✓	✓	✓	✓	✓	✓
		Multi (M)	✓	✓	✓	✓	✓	✓	✓	✓	✓	✓
LDM64TE	300m	Mantis Green (G)	✓	✓	✓	✓	✓	✓	✓	✓	✓	✓
		Steel Grey (S)	✓	✓	✓	✓	✓	✓	✓	✓	✓	✓
		Hi-vis Orange (H)	✓	✓	✓	✓	✓	✓	✓	✓	✓	✓
		Multi (M)	✓	✓	✓	✓	✓	✓	✓	✓	✓	✓
LDM94TE	3000m	Mantis Green (G)	✓	✓	✓	✓	✓	✓	✓	✓	✓	✓
		Steel Grey (S)	✓	✓	✓	✓	✓	✓	✓	✓	✓	✓
		Hi-vis Orange (H)	✓	✓	✓	✓	✓	✓	✓	✓	✓	✓
		Multi (M)	✓	✓	✓	✓	✓	✓	✓	✓	✓	✓



Excellent Line Management

- Won't bury in the spool
- Picks up less water
- Spools up and packs better on any reel
- No reel memory

Structurally Superior

- Reduces wind knots, backlashes, guides and rod tip wrap overs
- Ties more easily and holds knots better
- Near zero stretch
- Unbelievable strength-to-diameter ratio

Smoother and Slicker

- Sails effortlessly through the guides for longer casts
- Resists abrasion by equipment or natural hazards
- Won't cut guides
- Maintains performance over time

Spool		0.06mm 3.00kg	0.08mm 4.00kg	0.10mm 5.00kg	0.13mm 8.00kg	0.15mm 9.00kg	0.19mm 13.00kg	0.23mm 15.00kg	0.28mm 20.00kg	0.32mm 24.00kg	0.36mm 30.00kg	0.41mm 40.00kg	0.43mm 48.00kg	0.46mm 55.00kg	0.56mm 75.00kg	0.76mm 95.00kg	
PPBI	135m	Moss Green (MG)	✓	✓	✓	✓	✓	✓	✓	✓	✓	✓	✓	✓	✓	✓	
		White (W)	✓	✓	✓	✓	✓	✓	✓	✓	✓	✓	✓	✓	✓	✓	✓
		Yellow (Y)	✓	✓	✓	✓	✓	✓	✓	✓	✓	✓	✓	✓	✓	✓	✓
		Red (R)	✓	✓	✓	✓	✓	✓	✓	✓	✓	✓	✓	✓	✓	✓	✓
	275m	Moss Green (MG)	✓	✓	✓	✓	✓	✓	✓	✓	✓	✓	✓	✓	✓	✓	✓
		White (W)		✓	✓	✓	✓	✓	✓	✓	✓	✓	✓	✓	✓	✓	✓
		Yellow (Y)		✓	✓	✓	✓	✓	✓	✓	✓	✓	✓	✓	✓	✓	✓
		Red (R)		✓	✓	✓	✓	✓	✓	✓	✓	✓	✓	✓	✓	✓	✓
	455m	Moss Green (MG)			✓	✓	✓	✓	✓	✓	✓	✓	✓	✓	✓	✓	✓
		Yellow (Y)			✓	✓	✓	✓	✓	✓	✓	✓	✓	✓	✓	✓	✓
		Red (R)			✓	✓	✓	✓	✓	✓	✓	✓	✓	✓	✓	✓	✓
	1370m	Moss Green (MG)			✓	✓	✓	✓	✓	✓	✓	✓	✓	✓	✓	✓	✓
		Yellow (Y)			✓	✓	✓	✓	✓	✓	✓	✓	✓	✓	✓	✓	✓
		Red (R)			✓	✓	✓	✓	✓	✓	✓	✓	✓	✓	✓	✓	✓
	2740m	Moss Green (MG)			✓	✓	✓	✓	✓	✓	✓	✓	✓	✓	✓	✓	✓
		White (W)			✓	✓	✓	✓	✓	✓	✓	✓	✓	✓	✓	✓	✓
		Yellow (Y)			✓	✓	✓	✓	✓	✓	✓	✓	✓	✓	✓	✓	✓
		Red (R)			✓	✓	✓	✓	✓	✓	✓	✓	✓	✓	✓	✓	✓



POWER PRO Super Slick V2

- NEW now with even more power
- 8 braid construction with proven EBT technology
- Available in moss green and Hi-Visual aqua green
- Strong yet smooth and soft

Spool			0.13mm	0.15mm	0.19mm	0.23mm	0.28mm	0.32mm	0.36mm	0.41mm	0.43mm
			8kg	10kg	15kg	17kg	20kg	24kg	30kg	40kg	50kg
135m	Moss		✓	✓	✓	✓	✓	✓			
	Aqua		✓	✓	✓	✓	✓	✓			
	Moon		✓	✓	✓	✓	✓	✓			
275m	Moss		✓	✓	✓	✓	✓	✓	✓	✓	
	Aqua		✓	✓	✓	✓	✓	✓	✓	✓	
	Moon		✓	✓	✓	✓	✓	✓	✓	✓	
2740m	Moss		✓	✓	✓	✓	✓	✓	✓	✓	✓
	Aqua		✓	✓	✓	✓	✓	✓	✓	✓	✓
	Moon		✓	✓	✓	✓	✓	✓	✓	✓	✓



POWER PRO DEPTH-HUNTER

- Japanese engineered multi-coloured braided line
- Different colour bands at 10m intervals for optimized depth and distance control
- Perfect for trolling, vertical jigging and deep sea fishing applications
- Excellent line management

Spool		0.13mm	0.15mm	0.19mm	0.23mm	0.28mm	0.32mm	0.36mm	0.41mm
		8.00kg	9.00kg	13.00kg	15.00kg	20.00kg	24.00kg	30.00kg	40.00kg
PPBI	300m		✓	✓	✓	✓	✓	✓	✓
	1600m	✓	✓	✓	✓	✓	✓	✓	✓



POWER PRO BITE MOTION

- With POWER PRO Bite Motion you can detect bites by watching the line movement through black marks every meter that act as a strike indicator
- The indicator will detect the bite on the fall and allow anglers to react quickly
- This line is great for zander and pike fishing

Spool		0.10mm	0.13mm	0.15mm	0.19mm	0.23mm	0.28mm
		5.00kg	8.00kg	9.00kg	13.00kg	15.00kg	20.00kg
PPBI	1600m	✓	✓	✓	✓	✓	✓



CLOTHING

Outer clothing, caps, eye protection and other clothing accessories complete a truly impressive range of advanced, modern apparel for the advanced angler.

CLOTHING

12 TACTICAL WEAR CLOTHING RANGE

14 TRENCH WEAR CLOTHING RANGE

SUNGLASSES

18 SUNGLASSES



**TACTICAL
WEAR**

SPECIFIC DESIGNED CLOTHING RANGE BASED ON THE TRIBAL TACTICAL LUGGAGE



NEW AVAILABLE SPRING 2021

FLEECE LINED PULLOVER

- SHIMANO Tactical Wear branded fleece lined pullover with high neck fastening and adjustable velcro sleeves
- Shell: 100% Nylon, Lining: 260gsm Sherpa
- Available in: M / L / XL / 2XL / 3XL

• **CODE:** SHTTW02



NEW AVAILABLE SPRING 2021

HOODIE

- SHIMANO Tactical Wear branded hoodie with draw string neck and full frontal pocket
- 65% Polyester, 35% Cotton - 280gsm
- Available in: M / L / XL / 2XL / 3X

• **CODE:** SHTTW06



NEW AVAILABLE SPRING 2021

TAN T-SHIRT

- SHIMANO Tactical Wear branded tan t-shirt with large SHIMANO TRIBAL logo on the front
- 100% Cotton
- Available in: M / L / XL / 2XL / 3XL

• **CODE:** SHTTW15



NEW AVAILABLE SPRING 2021

BLACK T-SHIRT

- SHIMANO Tactical Wear branded black t-shirt with large SHIMANO TRIBAL logo on the front
- 100% Cotton
- Available in: M / L / XL / 2XL / 3XL

• **CODE:** SHTTW16



NEW AVAILABLE SPRING 2021

POLO SHIRT

- SHIMANO Tactical Wear branded polo shirt with SHIMANO TRIBAL logo on shoulder sleeve
- 100% Cotton
- Available in: M / L / XL / 2XL / 3XL

• **CODE:** SHTTW17



NEW

AVAILABLE SPRING 2021

JOGGERS

- SHIMANO Tactical Wear branded joggers with drawstring waistband
- 65% Polyester, 35% Cotton - 280gsm
- Available in: M / L / XL / 2XL / 3XL

• **CODE:** SHTTW09



NEW

AVAILABLE SPRING 2021

ZIP-OFF COMBAT TROUSERS

- SHIMANO Tactical Wear branded Ripstop zip-off combat trousers with large leg pockets
- Instantly converts to knee length shorts
- 100% Cotton
- Available in: M / L / XL / 2XL / 3XL

• **CODE:** SHTTW12



NEW

AVAILABLE SPRING 2021

CARGO TROUSERS

- SHIMANO Tactical Wear branded cargo trousers with drawstring cuffs at the bottom and two large leg pockets
- Shell: 100% Nylon, Lining: 260gsm Sherpa
- Available in: M / L / XL / 2XL / 3XL

• **CODE:** SHTTW13



NEW

KNIT BOBBLE HAT

- SHIMANO Tactical Wear branded knit bobble hat
- 100% Acrylic
- One size fits all

• **CODE:** SHTTW18



NEW

BEANIE

- SHIMANO Tactical Wear branded beanie
- 100% Acrylic
- One size fits all

• **CODE:** SHTTW20



NEW

CAP

- SHIMANO Tactical Wear branded cap
- 100% Cotton
- One size fits all

• **CODE:** SHTTW21

AVAILABLE SPRING 2021



NEW

LIGHT BUSH HAT

- SHIMANO Tactical Wear branded light bush hat
- 100% Cotton
- One size fits all

• **CODE:** SHTTW22



NEW AVAILABLE SPRING 2021

TRICAM T-SHIRT

- SHIMANO Trench Wear branded t-shirt with SHIMANO TRIBAL logo on shoulder
- 100% Cotton
- Available in: M / L / XL / 2XL / 3XL

• **CODE:** SHTTW14



NEW AVAILABLE SPRING 2021

HEAVY TRICAM JOGGERS

- SHIMANO Trench Wear branded joggers with drawstring waistband and elasticated cuffs at the bottom
- 65% Polyester, 35% Cotton - 320gsm
- Available in: M / L / XL / 2XL / 3XL

• **CODE:** SHTTW08



NEW AVAILABLE SPRING 2021

ZIPPED TRICAM HOODIE

- SHIMANO Trench Wear branded hoodie with full zip and drawstring hood
- 65% Polyester, 35% Cotton
- Available in: M / L / XL / 2XL / 3XL

• **CODE:** SHTTW05



NEW AVAILABLE SPRING 2021

MICRO FIBRE BUSH HAT

- SHIMANO Trench Wear branded, micro fibre bush hat
- 100% Polyester
- One size fits all

• **CODE:** SHTTW23

TRENCH WEAR CLOTHING / SUNGLASSES



BIOMASTER

- Polarized photo chromic lenses
- Silver Grilamid® TR90 Frame

• **CODE:** SUNBIO



CATANA BX

- Grilamid® TR90 frame
- Rubberized nose pads

• **CODE:** SUNCATBX



FORCEMASTER XT

- Polarized photo chromic lenses
- Silver Grilamid® TR90 Frame

• **CODE:** SUNFMXT



SPEEDMASTER

- Grilamid® TR90 floating frame
- Rubberized nose pads

• **CODE:** SUNSP02



FIREBLOOD

- Grilamid® TR90 Frame
- High contrast polarized lenses

• **CODE:** SUNFB



PURIST

- Floating Grilamid® TR90 Frame
- Ventilation openings

• **CODE:** SUNPUR02



AERNOS

- Shiny Black/Red Grilamid® TR90 frame
- Coloured polarised 0.65mm TAC lenses

• **CODE:** SUNAERNOS



TECHNIUM

- 3D Carbon look Grilamid® TR90 frame
- Coloured polarised 1.0mm TAC mirrored lenses

• **CODE:** SUNTEC



CURADO

- Black Grilamid® TR90 frame
- Yellow coloured polarised 1.0mm TAC lenses

• **CODE:** SUNC



ASPIRE

- Smoke coloured polarised TAC lenses for a wide variety of conditions
- 3D Carbon look frame

• **CODE:** SUNASP



BEASTMASTER

- Removable soft foam gasket for excellent protection
- Shiny black frame with yellow rubber inlay

• **CODE:** SUNBM02



STRADIC

- Lens adjustment system to help improve visibility during changeable light situations
- Shiny peel white frame

• **CODE:** SUNSTR



AERO

- Aero sunglasses feature two changeable grey & yellow coloured polarised lenses
- Shiny black frame

• **CODE:** SUNAER2



TIAGRA 2

- Blue mirrored polarised polycarbonate lenses for saltwater use
- Shiny dark navy frame

• **CODE:** SUNTIA2



YASEI

- Lightweight matte black Grilamid® TR90 frame

• **CODE:** SUNYASSM

• **CODE:** SUNYASGR



LUGGAGE

LINE

CLOTHING

EYEWEAR

LURES

BAIT



FISHING LURES

New to the European market, SHIMANO's lure range has already proven to be a great success in many countries throughout the world. The SHIMANO design department in Japan have developed a great range of technologies to make the lures as effective as possible. Two examples are KYORIN, a life-like hologram finish that mimics the scale patterns of bait fish with remarkable reality and the AR-C system, which improves casting distance and accuracy by incorporating a moving weight inside the lure. Both of these exclusive features help in assisting you to catch more fish!

FRESHWATER

- 261 FRESHWATER LURES DEPTH CHART
- 262 BANTAM LURES
- 266 CARDIFF HARDBAITS
- 271 CARDIFF SPOONS

SALTWATER

- 272 SALTWATER LURES DEPTH CHART
- 273 COLTSNIPER LURES
- 274 EXSENCE LURES
- 276 TIGER BAKU BAKU LURES
- 277 SOARE LURES
- 278 OCEA LURES
- 280 SEPHIA LURES

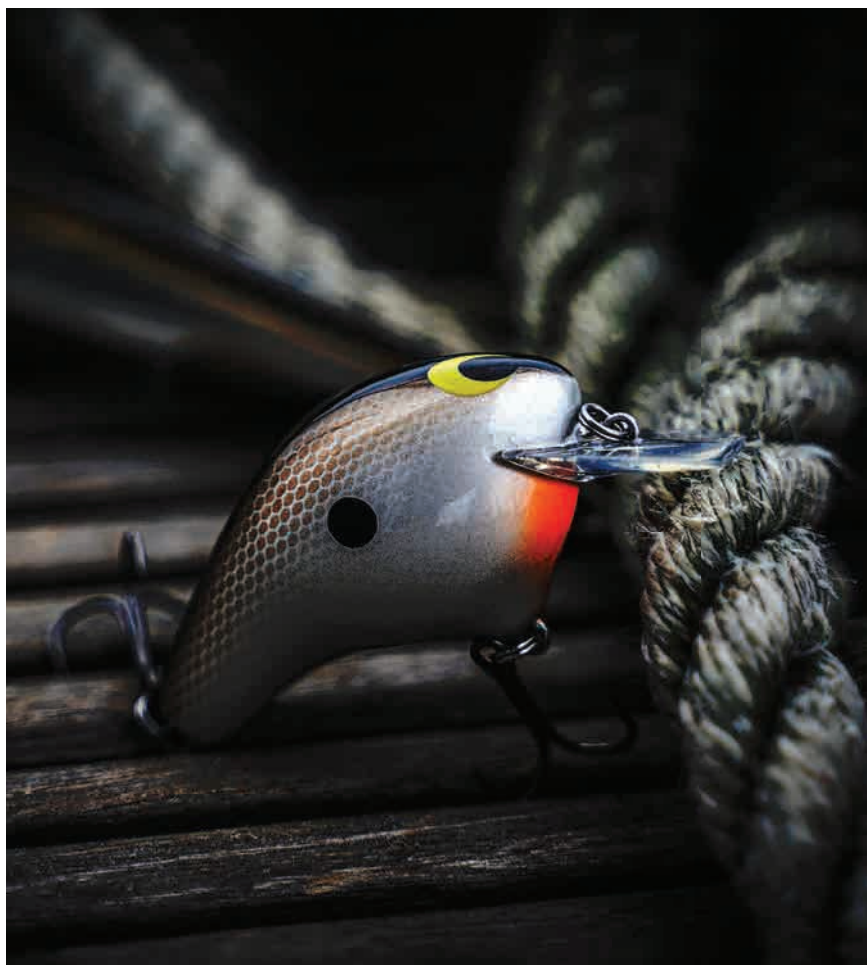

LURE TECHNOLOGY

THROUGH WIRE

Through wire construction connects the front connecting ring to all hook anchor points for failsafe performance.



MAGNETIC WEIGHT TRANSFER

A special magnet weight transfer system that results in longer casting distance and life-like head-up profile when paused.

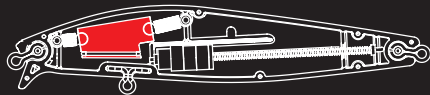

FLASH BOOST

Flash Boost technology suspends reflective mirror on small springs inside of the lure body. This allows the lure to constantly emit an attractive flash, even when stationary.

LURE MATERIALS



KYORIN

SHIMANO's three dimensional holographic film offers remarkable life-like reality. Following as closely as possible the scales of the fish it replicates, in terms of size, shape and overlap.

3X BODY

3X BODY is a combination of a materials plus a reinforced design which produces higher impact resistance and up to three times the strength of standard lure construction.



UV GLOW

Special natural holographic design for increased attraction.

LURE SYSTEMS

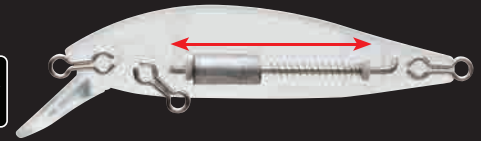

AR-C SYSTEM

The AR-C system uses an internal moving weight controlled by a spring-type centre of gravity control (PAT.P) system. During the cast, the weight moves backwards in the lure creating centrifugal force, which improves casting distance and accuracy. Once in the water, the spring automatically returns the weight to the correct central position for maximum swimming performance.



X AR-C SYSTEM

An innovative lure construction system combining a newly developed body material 'AR-C SHELL (PAT.P)' moulded with high buoyancy foam. This enables heavier weights to be used in the revolutionary 'AR-C system', which moves during and after casting. The result is longer casts combined with lures which can be retrieved very slowly in the upper layers of water.



JERK ASSIST BALANCER SYSTEM

Increases stability when the lure is being retrieved at hough speed, but allows for a darting action when twitched and jerked.

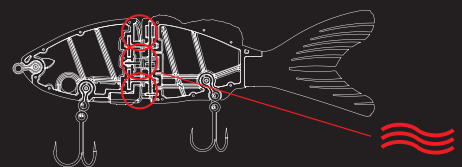

TRIPLE JOINT SYSTEM

The triple joint allows the lure to swim and move through the water like the real thing.



CENTRE BALANCE SYSTEM

Centre balance system creates sliding action followed by a rolling which is exactly like a gasp move of a dying baitfish trying to make an escape.

DEPTH CHARTS

Bantam FRESHWATER LURES

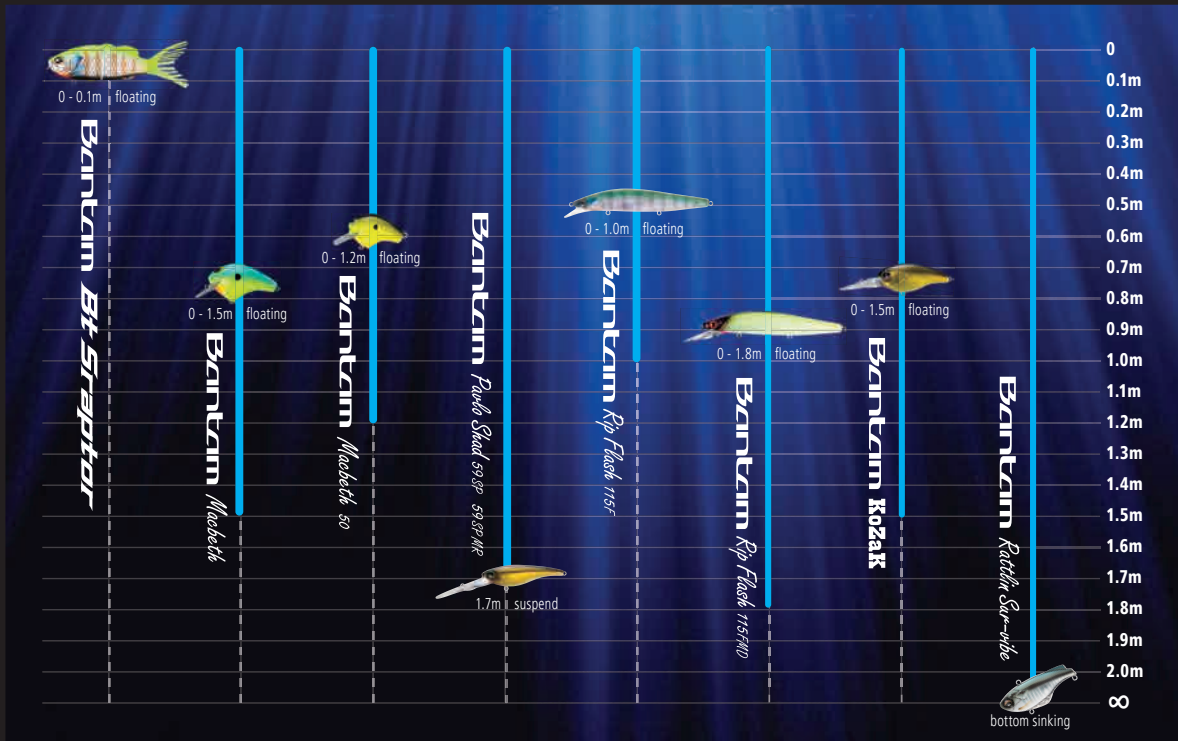

CARDIFF FRESHWATER LURES

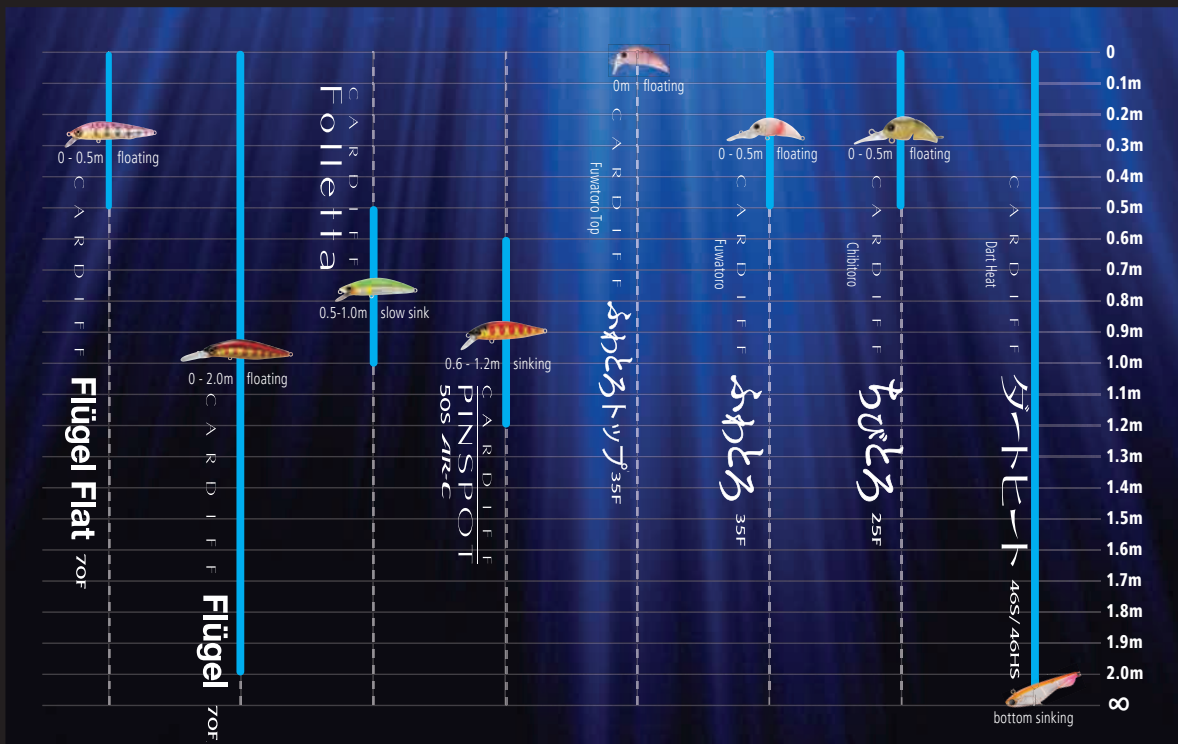

LUGGAGE

LINE

CLOTHING

EYEWEAR

LURES

BAIT



NEW

Bantam *Bt Sraptor*

- Escape swimming action with asymmetric tail design
- S-Line action
- Triple joint system
- Special sinker holder for buoyancy adjustment
- Works with constant and jerk/twitch retrieves
- Floating (can be adjusted to sink)



Asymmetric tail design

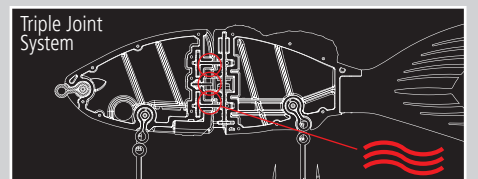

Triple Joint System



001

002

003

004

006



58.0g



182mm



0.1m



Floating

001

59VZR818T00

002

59VZR818T01

003

59VZR818T02

004

59VZR818T03

006

59VZR818T04

NEW

Bantam Macbeth

- Aggressive, wide kicking and rolling 'head-down' action
- Large square bill with rounded front corners
- Unique lower centre of gravity reduces snagging
- Quick start-up action on retrieve
- Works with constant and stop/start retrieves
- Floating - diving depth 1.5m

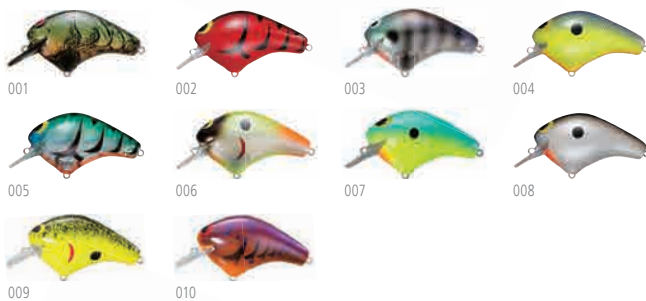

					001	002	003	004	005
59VZP106T	16.0g	63mm	0-1.5m	Floating	59VZP106T00	59VZP106T01	59VZP106T02	59VZP106T03	59VZP106T04
					006	007	008	009	010
59VZP106T	16.0g	63mm	0-1.5m	Floating	59VZP106T05	59VZP106T06	59VZP106T07	59VZP106T08	59VZP106T09

NEW

Bantam Macbeth 50

- Small compact version of the original Bantam Macbeth
- Aggressive, wide kicking and rolling 'head-down' action
- Large square bill with rounded front corners
- Unique lower centre of gravity reduces snagging
- Works with constant and stop/start retrieves
- Floating - diving depth 1.2m



					001	002	003	004	005
59VZP105T	12.0g	50mm	0-1.2m	Floating	59VZP105T00	59VZP105T01	59VZP105T02	59VZP105T03	59VZP105T04
					006	007	008	009	010
59VZP105T	12.0g	50mm	0-1.2m	Floating	59VZP105T05	59VZP105T06	59VZP105T07	59VZP105T08	59VZP105T09



NEW

Bantam Pavlo Shad 59SP

- High-speed retrieve with kicking action
- 'Jerk Assist Balancer System' increases stability when retrieved quickly
- Special darting action when twitched
- Works with constant and stop/start retrieves
- Excellent action for bouncing on the bottom in shallow water
- Suspending - diving depth 1.7m

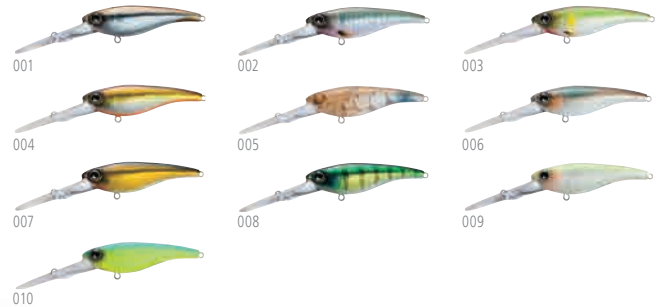
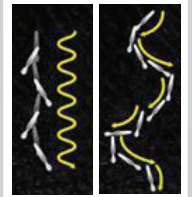
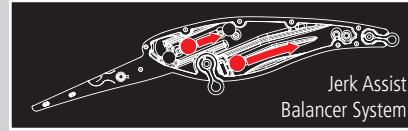

					001				
59VZM306T	6.0g	59mm	0-1.7m	Suspend	59VZM306T00	59VZM306T01	59VZM306T02	59VZM306T03	59VZM306T04
					006				
59VZM306T	6.0g	59mm	0-1.7m	Suspend	59VZM306T05	59VZM306T06	59VZP105T07	59VZM306T08	59VZM306T09



NEW

Bantam Rip Flash

- Floating minnow designed for ripping and jerking retrieves
- Extremely buoyant with square body creates swaying 'Shimmy Float Action' when ascending
- 'Jerk Assist Balancer System' increases stability when retrieved quickly
- Low tone rattle when jerked and ripped
- Floating - diving depth F (111P) - 1.0m, FMD (211P) - 1.8m

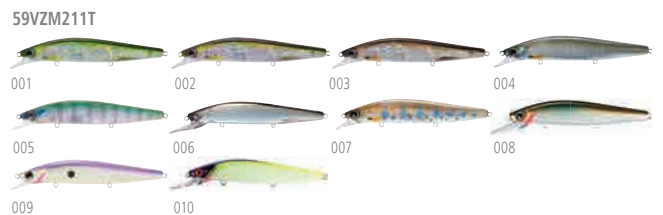

					001	002	003	004	005	006	007	008	009	010
59VZM111T	14.0g	115mm	0-1.0m	Floating	59VZM111T00	59VZM111T01	59VZM111T02	59VZM111T03	59VZM111T04	59VZM111T05	59VZM111T06	59VZM111T07	59VZM111T08	59VZM111T09
					001	002	003	004	005	006	007	008	009	010
59VZM211T	14.0g	115mm	0-1.8m	Floating	59VZM211T00	59VZM211T01	59VZM211T02	59VZM211T03	59VZM211T04	59VZM211T05	59VZM211T06	59VZM211T07	59VZM211T08	59VZM211T09

NEW

Bantam KoZaK

- Great tight swimming action at all speeds, from super slow to extra fast
- Deep rattle sound when moving
- Natural horizontal profile when being retrieved
- Available in SR (shallow runner) and MR (medium runner)
- Floating - diving depth SR - 1.0m, MR - 1.5m

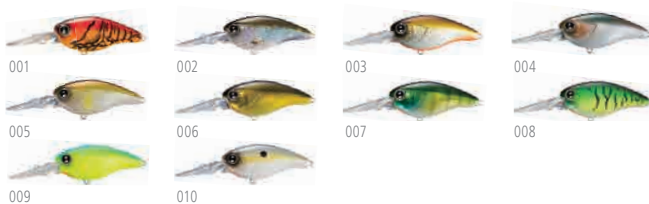

					001	002	003	004	005	006	007	008	009	010
59VZP205T	8.0g	54mm	0-1.0m	Floating	59VZP205T00	59VZP205T01	59VZP205T02	59VZP205T03	59VZP205T04	59VZP205T05	59VZP205T06	59VZP205T07	59VZP205T08	59VZP205T09
59VZP305T	8.0g	54mm	0-1.5m	Floating	59VZP305T00	59VZP305T01	59VZP305T02	59VZP305T03	59VZP305T04	59VZP305T05	59VZP305T06	59VZP305T07	59VZP305T08	59VZP305T09

NEW

Bantam Rattlin Sur-vibe

- Slim square body shape with a fast vibrating action
- Loud rattle sound when moving
- Can be worked with a steady retrieve or life and fall technique
- Head down design and buoyant tail works well on the bottom
- Sinking for fishing variable depths

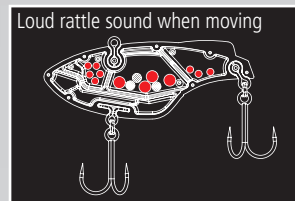

					001	002	003	004	005	006	007	008	009	010
59VZV107T	14.0g	62mm	Variable	Sinking	59VZV107T00	59VZV107T01	59VZV107T02	59VZV107T03	59VZV107T04	59VZV107T05	59VZV107T06	59VZV107T07	59VZV107T08	59VZV107T09

LUGGAGE
LINE
CLOTHING
EYEWEAR
LURES
BAIT



NEW

CARDIFF Flügel Flat 70F

- Floating minnow design with extremely life-like details and colours
- Magnet weight transfer for longer casting distance and improved action
- Wide swimming action when retrieved with a constant speed
- Flashing action when fished with small jerks
- Floating - diving depth 0.5m

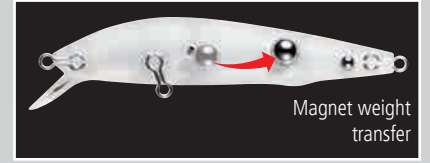

59VZNM70T	5.0g	70mm	0-0.5m	Floating	001	002	003	004	005	006	007	008	009
					59VZNM70T00	59VZNM70T01	59VZNM70T02	59VZNM70T03	59VZNM70T04	59VZNM70T05	59VZNM70T06	59VZNM70T07	59VZNM70T08



NEW

CARDIFF Flügel 70F AR-C

- Deep running, highly stable floating minnow
- SHIMANO AR-C system for increased casting distances
- Stable running, even at high speed and in strong currents
- Exceptional darting action when giving small jerks
- Floating - diving depth 2.0m

AR-C



59VZN170T	7.8g	70mm	0-2.0m	Floating	001	002	003	004	005	006	007	008
					59VZN170T00	59VZN170T01	59VZN170T02	59VZN170T03	59VZN170T04	59VZN170T05	59VZN170T06	59VZN170T07

CARDIFF FRESHWATER LURES



NEW

CARDIFF Folletta

- Slow sinking minnow with fixed centre of gravity
- Wide kicking action when twitched
- Tight rolling action on constant retrieve
- Highly realistic patterns and colours
- Slow Sinking - diving depth 1.0m



					001	002	003	004	005	006
59VTN251T	3.3g	50mm	0.5-1.0m	Slow Sink	59VTN251T00	59VTN251T01	59VTN251T02	59VTN251T03	59VTN251T04	59VTN251T05
					007	008	009	010	011	
59VTN251T	3.3g	50mm	0.5-1.0m	Slow Sink	59VTN251T06	59VTN251T07	59VTN251T08	59VTN251T09	59VTN251T0A	



NEW

CARDIFF PINSPOT 50s AR-C

- Small size sinking minnow design
- AR-C system for increased casting distance
- Wide erratic kicking action when twitched
- Tight rolling action on constant retrieve
- Flat sided body creates increased flash
- Sinking - diving depth 1.2m

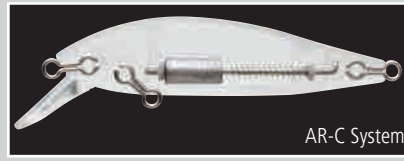

AR-C System



					001	002	003	004	005	006	007	008	009	010
59VTN250T	3.5g	50mm	0.6-1.2m	Sinking	59VTN250T00	59VTN250T01	59VTN250T02	59VTN250T03	59VTN250T04	59VTN250T05	59VTN250T06	59VTN250T07	59VTN250T08	59VTN250T09

LUGGAGE

LINE

CLOTHING

EYEWEAR

LURES

BAIT

NEW**CARDIFF FUWATORO TOP**

- Small floating top water jointed crankbait for trout and chub
- Designed for ultra slow retrieve
- Enticing wobbling body action even at the slowest speeds
- Large front lip for extra splash when twitched
- Floating - diving depth 0m

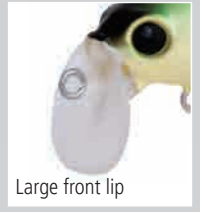

					001	002	003	004	005	006	007	008	009	010
59VTR035T	2.5g	35mm	0m	Floating	59VTR035T00	59VTR035T01	59VTR035T02	59VTR035T03	59VTR035T04	59VTR035T05	59VTR035T06	59VTR035T07	59VTR035T08	59VTR035T09

NEW**CARDIFF FUWATORO**

- One of Japan's best selling Trout Area lures
- Easy to use small floating jointed crankbait
- Designed for ultra slow retrieve
- Enticing wobbling body action even at the slowest speeds
- Floating - diving depth 0.5m



					001	002	003	004	005	006	007	008	009	010
59VTR135T	2.5g	35mm	0-0.5m	Floating	59VTR135T00	59VTR135T01	59VTR135T02	59VTR135T03	59VTR135T04	59VTR135T05	59VTR135T06	59VTR135T07	59VTR135T08	59VTR135T09

NEW

CARDIFF CHIBITORO

- A smaller 25mm version of the Fuwatoro 35F
- Jointed crankbait design for ultra slow retrieve
- Enticing wobbling body action even at the slowest speeds
- Large front lip for extra splash when twitched
- Floating - diving depth 0.5m



59VTR125T	1.4g	25mm	0-0.5m	Floating	001	002	003	004	005	006	007	008	009	010
					59VTR125T00	59VTR125T01	59VTR125T02	59VTR125T03	59VTR125T04	59VTR125T05	59VTR125T06	59VTR125T07	59VTR125T08	59VTR125T09

NEW

CARDIFF DART HEAT

- Special darting action when giving small jerks
- Attractive wobble during the descend
- Stand-up position on the bottom
- Excellent lure for deep water trout fishing
- Sinking



59VTN246T	4.6g	47mm	-	Sinking	001	002	003	004	005	006	007	008	009	010
					59VTN246T00	59VTN246T01	59VTN246T02	59VTN246T03	59VTN246T04	59VTN246T05	59VTN246T06	59VTN246T07	59VTN246T08	59VTN246T09

NEW

CARDIFF
Slim Swimmer

- Ideal for trout fishing
- Long, narrow microspoon that distributes the weight of the wave over a wider surface, allowing the spoon to sink very slowly
- A wave with excellent casting quality
- Perfect for probing surface water layers
- Available in 3 camo colours, 4 solid colours and various two tone gold/silver premium plating options
- CE - 'a Compact Edition' is available in selected colours

**CE**

Compact Edition (**CE**) maintains the lure length but increases the body volume for longer casting, easier swimming action and better depth.

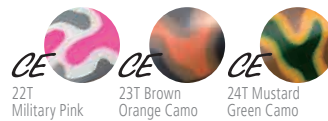

CAMO			22T	23T	24T
5VTRA20R	2.0g	28mm	5VTRA20R22	5VTRA20R23	5VTRA20R24
5VTRA36R	3.6g	33mm	5VTRA36R22	5VTRA36R23	5VTRA36R24
5VTRA44R	4.4g	40mm	5VTRA44R22	5VTRA44R23	5VTRA44R24

PREMIUM			05S	12S	15S	16S	60T	62T	63T	64T	65T	66T
5VTRS20N	2.0g	28mm	5VTRS20N05	5VTRS20N12	5VTRS20N15	5VTRS20N16	5VTRS20N60	5VTRS20N62	5VTRS20N63	5VTRS20N64	5VTRS20N65	5VTRS20N66
5VTRS36N	3.6g	33mm	5VTRS36N05	5VTRS36N12	5VTRS36N15	5VTRS36N16	5VTRS36N60	5VTRS36N62	5VTRS36N63	5VTRS36N64	5VTRS36N65	5VTRS36N66
5VTRS44N	4.4g	40mm	5VTRS44N05	5VTRS44N12	5VTRS44N15	5VTRS44N16	5VTRS44N60	5VTRS44N62	5VTRS44N63	5VTRS44N64	5VTRS44N65	5VTRS44N66

NEW

CARDIFF
Wobble Swimmer

- A Trout Area game spoon with single hooks
- Specific for trout fishing in a pond
- The last wave model added to the 'Cardiff' family
- Available in 4 camo colours and 4 two tone designs



			03T	06T	21T	22T	23T	24T	25T	63T
5VTR015L	1.5g	28mm	5VTR015L03	5VTR015L06	5VTR015L21	5VTR015L22	5VTR015L23	5VTR015L24	5VTR015L25	5VTR015L63
5VTR025L	2.5g	30mm	5VTR025L03	5VTR025L06	5VTR025L21	5VTR025L22	5VTR025L23	5VTR025L24	5VTR025L25	5VTR025L63

NEW

CARDIFF *Roll Swimmer*

- A Trout Area game spoon with single hooks
- These have an irresistible roll which will fool not only wary Trout but also Perch!
- Available in 3 camo colours, solid colours and various two tone gold/silver premium plating options
- CE - 'a Compact Edition' is available in all 4.5g models



CAMO	g	mm	22T	23T	24T						
5VTRC15R	1.5g	21mm	5VTRC15R22	5VTRC15R23	5VTRC15R24						
5VTRC25R	2.5g	28mm	5VTRC25R22	5VTRC25R23	5VTRC25R24						
5VTRC35R	3.5g	28mm	5VTRC35R22	5VTRC35R23	5VTRC35R24						
5VTRC45R	4.5g	29mm	5VTRC45R22	5VTRC45R23	5VTRC45R24						
PREMIUM	g	mm	70T	71T	72T	73T	75T	77T	78T		
5VTRM15R	1.5g	21mm	5VTRM15R70	5VTRM15R71	5VTRM15R72	5VTRM15R73	5VTRM15R75	5VTRM15R77	5VTRM15R78		
5VTRM25R	2.5g	28mm	5VTRM25R70	5VTRM25R71	5VTRM25R72	5VTRM25R73	5VTRM25R75	5VTRM25R77	5VTRM25R78		
5VTRM35R	3.5g	28mm	5VTRM35R70	5VTRM35R71	5VTRM35R72	5VTRM35R73	5VTRM35R75	5VTRM35R77	5VTRM35R78		
CE	g	mm	05S	12S	16S	60T	62T	63T	64T	65T	66T
5VTRR45N	4.5g	29mm	5VTRR45N05	5VTRR45N12	5VTRR45N16	5VTRR45N60	5VTRR45N62	5VTRR45N63	5VTRR45N64	5VTRR45N65	5VTRR45N66

NEW

CARDIFF *Search Swimmer*

- A Trout Area game spoon with single hooks
- Available in various solid colours and 4 two tone gold/silver premium plating options



	g	mm	03S	05S	06S	08S	12S	16S	62T	63T	64T	66T
5VTR218Q	1.8g	25mm	5VTR218Q03	5VTR218Q05	5VTR218Q06	5VTR218Q08	5VTR218Q12	5VTR218Q16	5VTR218Q62	5VTR218Q63	5VTR218Q64	5VTR218Q66
5VTR225Q	2.5g	27mm	5VTR225Q03	5VTR225Q05	5VTR225Q06	5VTR225Q08	5VTR225Q12	5VTR225Q16	5VTR225Q62	5VTR225Q63	5VTR225Q64	5VTR225Q66
5VTR235Q	3.5g	28mm	5VTR235Q03	5VTR235Q05	5VTR235Q06	5VTR235Q08	5VTR235Q12	5VTR235Q16	5VTR235Q62	5VTR235Q63	5VTR235Q64	5VTR235Q66

DEPTH CHARTS

SALTWATER LURES - FLOATING

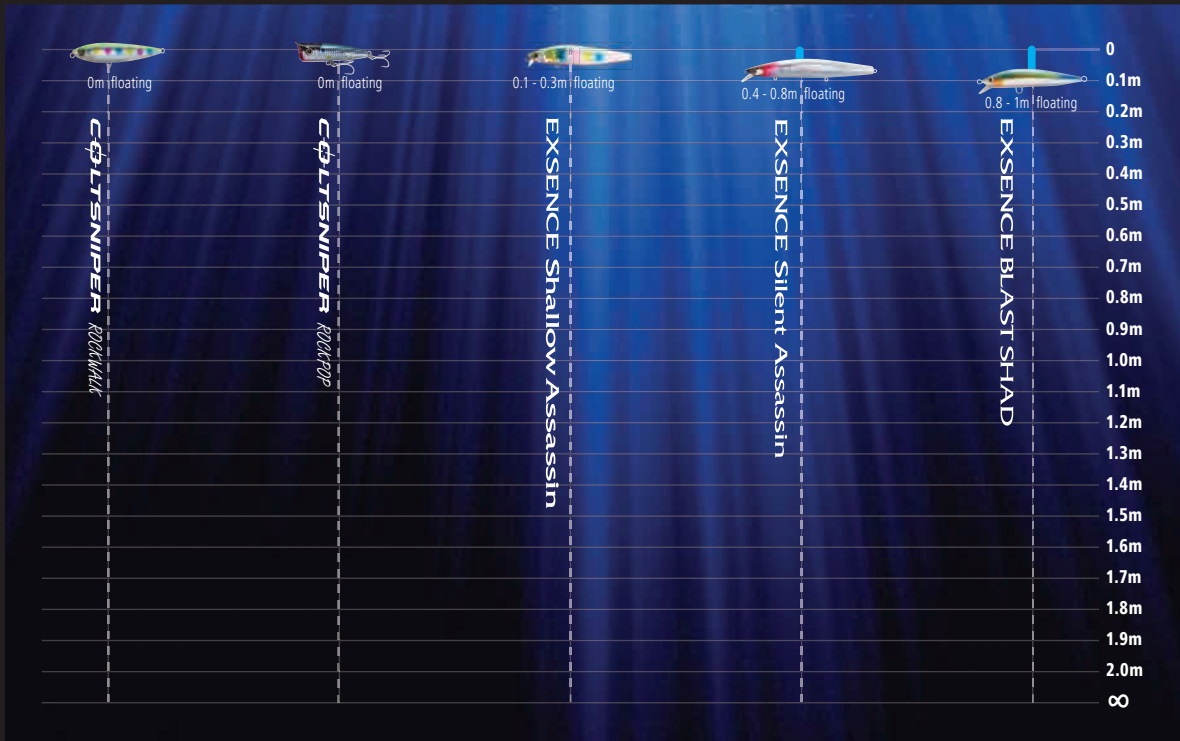

SALTWATER LURES - SINKING

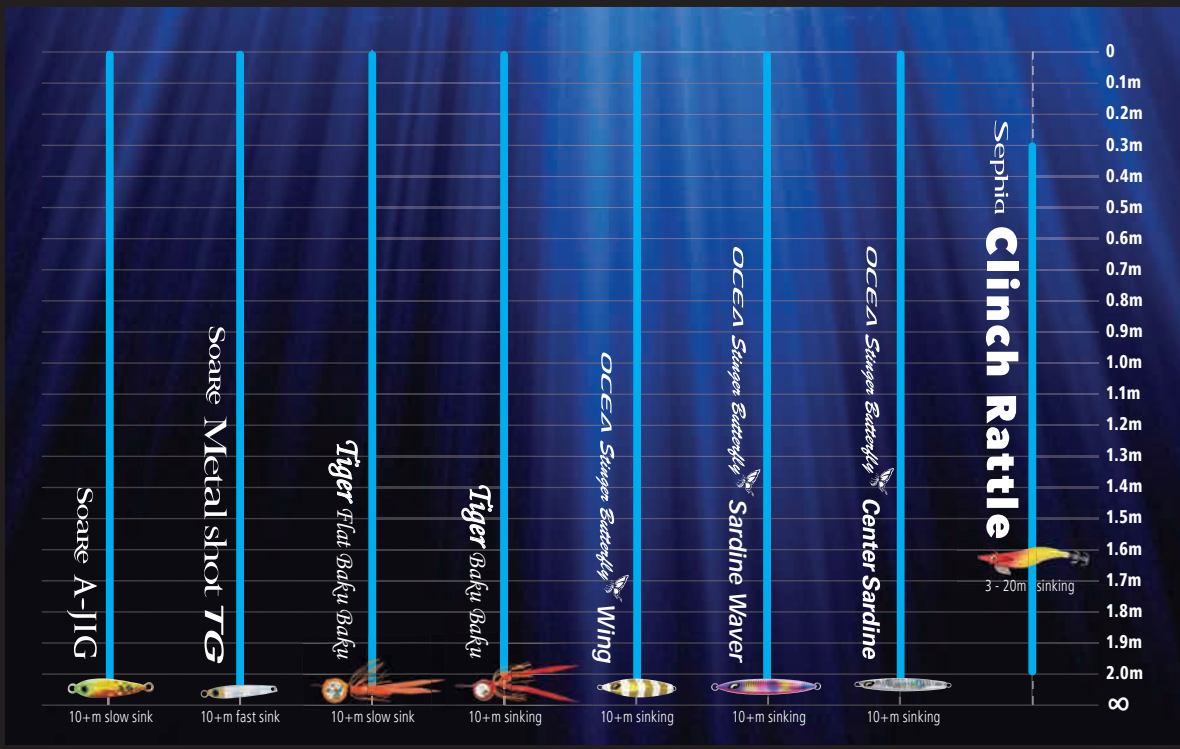

DIVING DEPTH

DIVING DEPTH



COLTSNIPER ROCKWALK

- Perfect for fishing using the 'walk the dog' action
- Compact, slim body replicating bait fish
- Sensitive twitching makes the lure swing its head
- Available in 8 colour patterns
- Floating design for fishing the upper layers and surface



					001	002	003	004	005	006	007	008
59VOT111S	23g	110mm	0m	Floating	59VOT111S00	59VOT111S01	59VOT111S02	59VOT111S03	59VOT111S04	59VOT111S05	59VOT111S06	59VOT111S07



COLTSNIPER ROCKPOP

- Popper type lure with front bubble chamber
- Can be worked at different speeds, emanating bubbles from its twin bubble chamber and producing loud popping sounds
- Design that balances the bubble force and stable popping
- Available in 4 colour patterns



					01T	02T	04T	06T
59VOP190Q	23g	90mm	0m	Floating	59VOP190Q01	59VOP190Q02	59VOP190Q04	59VOP190Q06



EXSENCE

SILENT ASSASSIN 129F

- Available in the hugely popular 129mm, perfect for sea bass fishing
- Equipped with AR-C system for increased casting distance and accuracy
- Floating design for fishing the top layers and surface



				01T	001	03T	003	005	08T	006	10T	
59VXM129N	22g	129mm	0.5-0.8m	Floating	59VXM129N01	59VXM129N00	59VXM129N03	59VXM129N02	59VXM129N04	59VXM129N08	59VXM129N05	59VXM129N10

EXSENCE

SILENT ASSASSIN 140F

- Equipped with AR-C system for increased casting distance and accuracy
- Floating design for fishing the top layers and surface



				01T	02T	03T	04T	05T	08T	09T	10T	
59VXM140N	23g	140mm	0.6-0.7m	Floating	59VXM140N01	59VXM140N02	59VXM140N03	59VXM140N04	59VXM140N05	59VXM140N08	59VXM140N09	59VXM140N10

EXSENCE

SILENT ASSASSIN 160F

- Large minnow type lure often used in harbours, estuaries and surf
- Ideal for situations where you want to introduce a big lure that combines distance and action
- Floating design for fishing the top layers and surface



				001	002	003	004	005	006	007	008	
59VXM160S	32g	160mm	0.4-0.8m	Floating	59VXM160S00	59VXM160S01	59VXM160S02	59VXM160S03	59VXM160S04	59VXM160S05	59VXM160S06	59VXM160S07

EXSENCE SALTWATER LURES

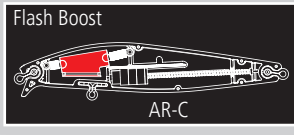

FLASHBOOST **AR-C**

NEW

EXSENCE Shallow Assassin 99F FLASH BOOST

- Floating minnow designed for sea bass fishing
- Flash Boost feature increases 'flash' from the lure even when stationary
- Equipped with AR-C system for increased casting distance and accuracy
- Floating - diving depth 0.3m

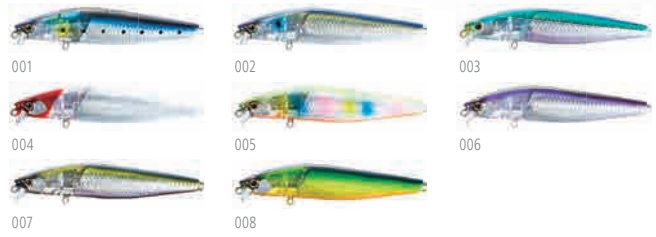

					001	002	003	004	005	006	007	008
59VXM199T	14g	99mm	0.10-0.30m	Floating	59VXM199T001	59VXM199T002	59VXM199T003	59VXM199T004	59VXM199T005	59VXM199T006	59VXM199T007	59VXM199T008



AR-C

NEW

EXSENCE BLAST SHAD

- Medium/large floating minnow which creates a lot of disturbance
- Fast rolling and flashing action
- Dives to 1.0m to cover sub-surface feeding fishing
- Equipped with AR-C system for increased casting distance and accuracy
- Floating - diving depth 1.0m



					001	002	003	004	005	006	007	008
59VXM114T	35g	140mm	0.8-1.0m	Floating	59VXM114T001	59VXM114T002	59VXM114T003	59VXM114T004	59VXM114T005	59VXM114T006	59VXM114T007	59VXM114T008
					001	002	003	004	005	006	007	008
59VXM117T	55g	170mm	0.8-1.0m	Floating	59VXM117T001	59VXM117T002	59VXM117T003	59VXM117T004	59VXM117T005	59VXM117T006	59VXM117T007	59VXM117T008

LUGGAGE

LINE

CLOTHING

EYEWEAR

LURES

BAIT

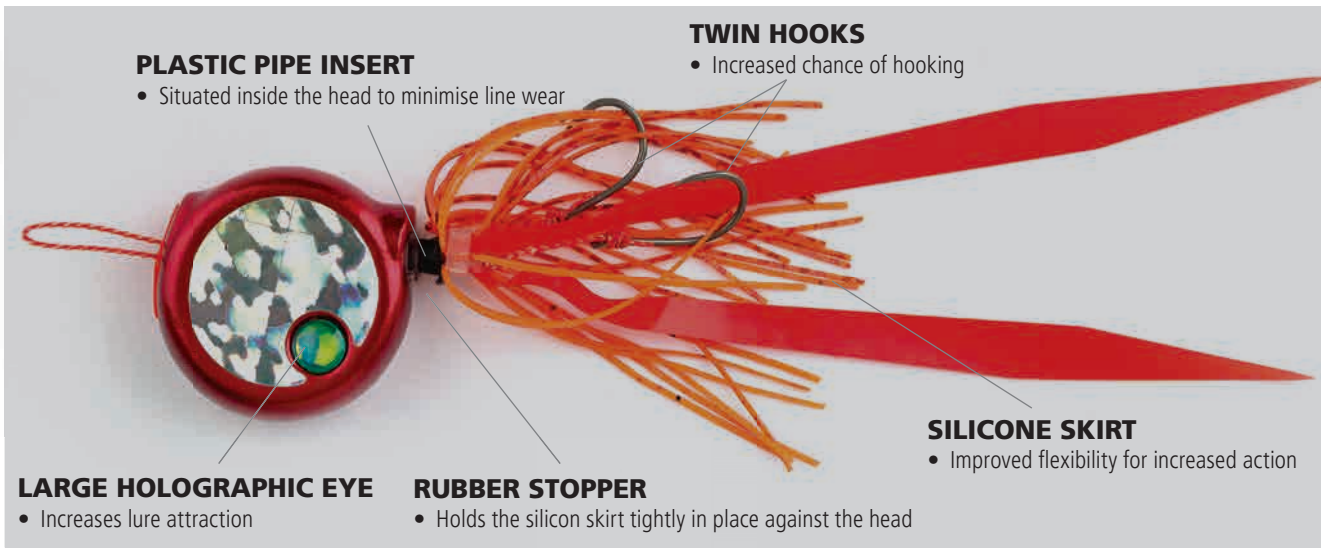

Tiger Baku Baku

- The Tiger Baku Baku design utilises a low centre of gravity head shape that creates a resonance when moving through the water
- Its shape also produces a complex flow of water behind the head, which creates a unique 'fish attracting' action from the silicon skirts
- Can be fished vertically or cast and retrieve or slow trolling due to the head stability
- 3D holographic eyes for increased attraction
- Enhanced colour combinations and special silicon skirts for improved movement
- Low centre of gravity head shape creates an attractive resonance when moving through water
- Fluorine coating on hooks for better hookset

Flat Baku Baku

- Flat Baku Baku has a flat head profile which shakes and sways with a wave motion on the fall to attract fish
- The wide front mouth enables the line to automatically locate to the correct position depending on if the lure is falling or rising
- 3D holographic eyes for increased attraction
- Enhanced colour combinations and special silicon skirts for improved movement
- Twin assist hooks for more reliable hook-ups
- Fluorine coating on hooks for better hookset

				01J	02J	61T	62T
TIGER BAKU BAKU							
59VEJ408Q	80g	10+m	Sinking	59VEJ408QA1	59VEJ408QA2	59VEJ408Q61	59VEJ408Q62
59VEJ410Q	100g	10+m	Sinking	59VEJ410QA1	59VEJ410QA2	59VEJ410Q61	59VEJ410Q62
59VEJ412Q	120g	10+m	Sinking	59VEJ412QA1	59VEJ412QA2	59VEJ412Q61	59VEJ412Q62



				001	002	003	004	005
FLAT BAKU BAKU								
59VEJ708S	80g	10+m	Sinking	59VEJ708S00	59VEJ708S01	59VEJ708S02	59VEJ708S03	59VEJ708S04
59VEJ710S	100g	10+m	Sinking	59VEJ710S00	59VEJ710S01	59VEJ710S02	59VEJ710S03	59VEJ710S04





Soare A-JIG

- Horizontal, slow action, free fall metal jig
- Specifically designed for mackerel fishing
- In free fall, the centre of gravity is towards the front which accelerates the descent
- Available in 4 colour patterns



001



003



002



005



6.5g



35mm



10+m



Sinking

001

59VSS265Q00

002

59VSS265Q01

003

59VSS265Q02

005

59VSS265Q04

59VSS265Q



NEW

Soare Metal shot *TG*

- Made from high density tungsten producing a compact body profile
- Designed for micro jigging
- Falls to the bottom more quickly than lead alternatives
- Special natural holographic design perfectly mimics a wounded baitfish
- Can be used from the shore or vertically from a boat

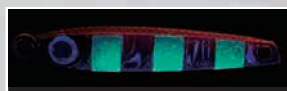

Special natural holographic design



Made of Tungsten



001



002



003



004



3g



25mm



10+m



Sinking

001

59VSS203T00

002

59VSS203T01

003

59VSS203T02

004

59VSS203T03

59VSS203T

59VSS205T

5g

30mm

10+m

Sinking

59VSS205T00

59VSS205T01

59VSS205T02

59VSS205T03

59VSS207T

7g

35mm

10+m

Sinking

59VSS207T00

59VSS207T01

59VSS207T02

59VSS207T03

FALLING ACTION



ONE PITCH JERK

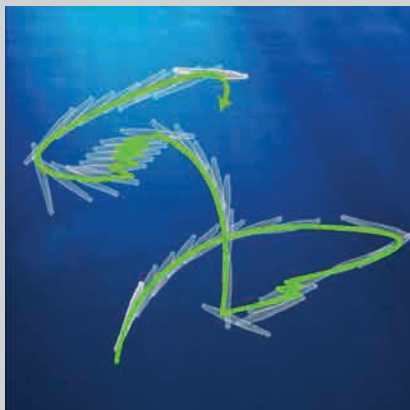

COMBINATION JERK



UV glow eye for increased attraction

OCEA

Stinger Butterfly **Wing**

- Designed for slow jigging style
- The specially designed contours on the body impart a sliding motion which mimics injured prey
- When released it will slowly flutter replicating a falling dead fish
- UV glow eye for increased attraction



	g	mm	m		25T	27T	28T	001 / 39T
59VJT511M	110g	98mm	10+m	Sinking	59VJT511M25	-	59VJT511M28	59VJT511M00
59VJT513M	135g	105mm	10+m	Sinking	59VJT513M25	59VJT513M27	59VJT513M28	59VJT513M00
59VJT516M	160g	112mm	10+m	Sinking	59VJT516M25	59VJT516M27	59VJT516M28	59VJT516M39

LUGGAGE
LINE
CLOTHING
EYEWEAR
LURES
BAIT

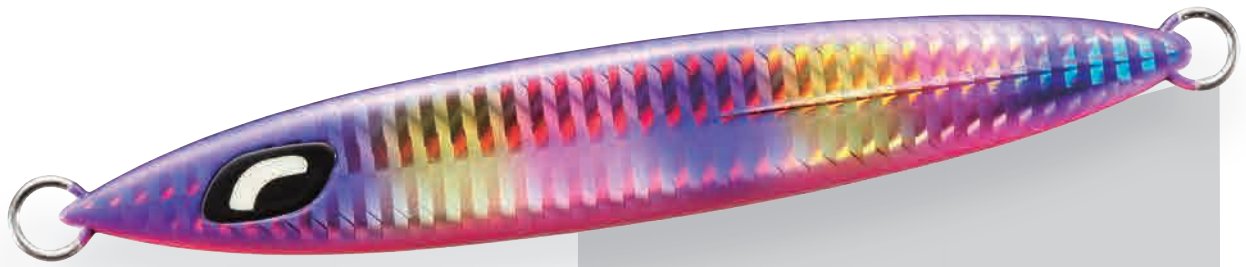

NEW

OCEA

Stinger Butterfly **Sardine Waver**

- Can be fished with a variety of actions
- Produces 3 types of actions automatically: back sliding, wobbling fall and slide back and forth
- All-around lure ideal for grouper or tuna
- Available in 4 colour patterns from 130g - 160g

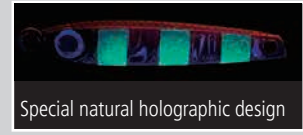

					002	003	004	005
59VJT413P	130g	121mm	10+m	Sinking	59VJT413P01	59VJT413P02	59VJT413P03	59VJT413P04
59VJT416P	160g	130mm	10+m	Sinking	59VJT416P01	59VJT416P02	59VJT416P03	59VJT416P04



NEW COLOURS

OCEA

Stinger Butterfly **Center Sardine**

- Centre balance system creates sliding action followed by a rolling body to imitate injured bait fish
- Discrete flashing, perfectly mimics a wounded baitfish
- Special natural holographic design
- Very effective when slow jigging in a school of baitfish
- Available in 88mm (50g) and 99mm (70g)

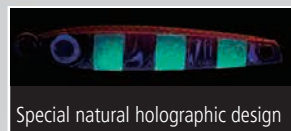

					002	003	004	006	007	008	009	010	011	012
59VJT705T	50g	88mm	10+m	Sinking	-	-	-	59VJT705T05	59VJT705T06	59VJT705T07	59VJT705T08	59VJT705T09	59VJT705T0A	59VJT705T0B
59VJT707T	70g	99mm	10+m	Sinking	-	-	-	59VJT707T05	59VJT707T06	59VJT707T07	59VJT707T08	59VJT707T09	59VJT707T0A	59VJT707T0B
59VJT707L	70g	99mm	10+m	Sinking	59VJT707L01	59VJT707L02	59VJT707L03	-	-	-	-	-	-	-

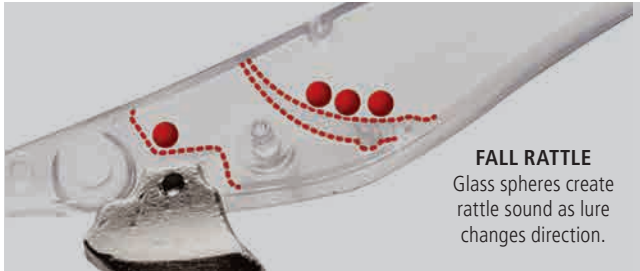

FALL RATTLE
Glass spheres create rattle sound as lure changes direction.

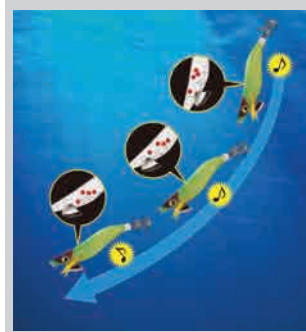

FALL RATTLE
Usually Egi only rattle when they are twitched and jerked. The Clinch Rattle series is equipped with the original 'rattle system', which produces sound when falling in a straight or curved trajectory.

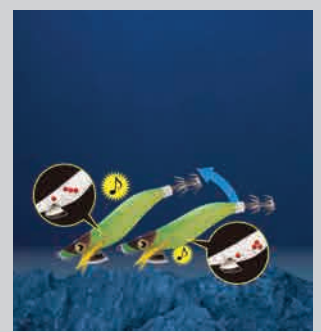

STATIC RATTLE
When touching the bottom, the buoyancy of Egi lifts the body, changing the angle and producing sound from the glass rattle inside. Also, the Egi fluctuates with a slight water flow for increased attraction.



Sephia Clinch Rattle

- Designed with lumo glow properties (tail only) and UV cloth for maximum attraction
- Ideal for Summer and Autumn
- Very effective in the 3m - 20m depth range
- Sharp edge head for better darting action
- High quality Japanese hooks for assured hooking



	g	GOU		001	002	003	004	005	006	007
59VQEJ25S	10g	2.5GOU	Sinking - 4 s/m	59VQEJ25S00	59VQEJ25S01	59VQEJ25S02	59VQEJ25S03	59VQEJ25S04	59VQEJ25S05	59VQEJ25S06
59VQEJ30S	15g	3.0GOU	Sinking - 3 s/m	59VQEJ30S00	59VQEJ30S01	59VQEJ30S02	59VQEJ30S03	59VQEJ30S04	59VQEJ30S05	59VQEJ30S06
59VQEJ35S	19g	3.5GOU	Sinking - 3.5 s/m	59VQEJ35S00	59VQEJ35S01	59VQEJ35S02	59VQEJ35S03	59VQEJ35S04	59VQEJ35S05	59VQEJ35S06
	g	GOU		008	009	010	011	012	013	014
59VQEJ25S	10g	2.5GOU	Sinking - 4 s/m	59VQEJ25S07	59VQEJ25S08	59VQEJ25S09	59VQEJ25S0A	59VQEJ25S0B	59VQEJ25S0C	59VQEJ25S0D
59VQEJ30S	15g	3.0GOU	Sinking - 3 s/m	59VQEJ30S07	59VQEJ30S08	59VQEJ30S09	59VQEJ30S0A	59VQEJ30S0B	59VQEJ30S0C	59VQEJ30S0D
59VQEJ35S	19g	3.5GOU	Sinking - 3.5 s/m	59VQEJ35S07	59VQEJ35S08	59VQEJ35S09	59VQEJ35S0A	59VQEJ35S0B	59VQEJ35S0C	59VQEJ35S0D



ISOLATE BAIT

There are two ranges in the SHIMANO carp bait collection - ISOLATE and TX1.

ISOLATE combines the finest quality ingredients, selected for their nutritional profile, easy digestibility and long term attraction. Proven ingredients, blended to unique ISOLATE formulas, deliver multiple layers of attraction and feeding stimulation. Boilies, pop-ups, wafers, liquids and glugs, as well as pellets are available for maximum feeding versatility.

The TX1 bait range offers fantastic value and is perfect for the casual carp fisherman. Packed with quality ingredients and enhanced flavourings to promote quick bites, the range comprises boilies, pop-ups, liquids and glugs.

ISOLATE

282 LM94 POP UPS · RN20 POP UPS

LM94 WAFTERS · RN20 WAFTERS

283 LM94 LIVER BOILIES · RN20 RED BOILIES

285 PELLETS

LM94 SYRUP · RN20 SYRUP

LM94 GLUG · RN20 GLUG

TX1

286 TX1 BOILIES

287 TX1 POP UP

TX1 GLUG · TX1 SYRUP



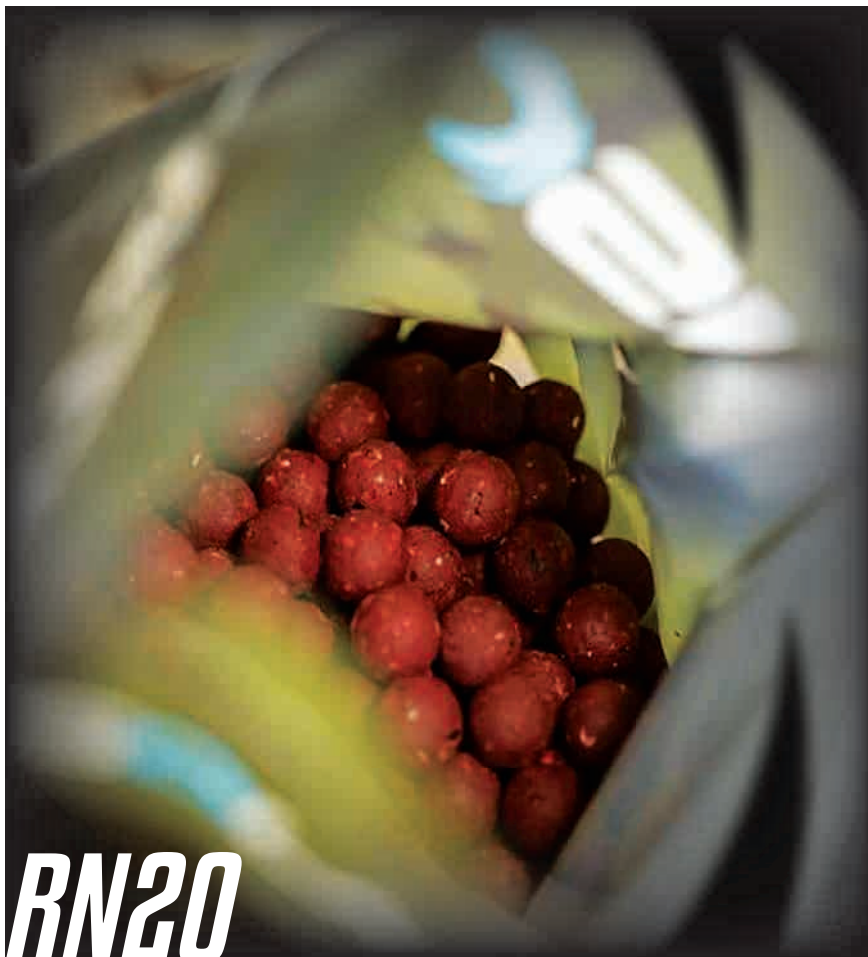

ISOLATE

LM94 & RN20 POP-UPS & WAFTERS

- ISOLATE pop-ups and wafers make brilliant alternative hookbaits
- Pop-ups available in LM94 & RN20 in 2 sizes: 12mm and 15mm
- Wafers available in LM94 & RN20 in 15mm
- 100g weight pots



LM94 POP-UP		
ISOLM94PU12100	12mm	100g
ISOLM94PU15100	15mm	100g
LM94 WAFTERS		
ISOLM94WF15100	15mm	100g
RN20 POP-UP		
ISORN20PU12100	12mm	100g
ISORN20PU15100	15mm	100g
RN20 WAFTERS		
ISORN20WF15100	15mm	100g



Ingredients

LM94
Corn, Lt94 Fishmeal, Wheat, Full Fat Toasted Soya, Egg Powder, Spices Mix, Birdfood Seed, Liver Powder, Hydrolysed Animal By-Products, Vegetable Protein Extract, Minerals, Preservatives

RN20
Chickenmeal, Egg Powder, Corngrits, Crushed Toasted Soybeans, Extruded Cornflour, Tigernut Flour, Toasted Peanut Meal, Kelp, Chia Seeds, Rape Seeds, Niger Seeds, Oyster Shells, Yeast, Spray Dried Chickenmeal, Betain, Spirulina, Preservatives



ISOLATE LM94 BOILIES

- LM94 is a complex fishmeal based boilie containing LT94 fishmeal, hydrolysed krill, digested liver, liver powder, N-butyric acid, vegetable protein and a powerful blend of seeds and minerals
- LT94 is a low temperature fishmeal recognised for it's premium quality
- Hydrolysed krill is a known carp attractor, high in crude protein, Omega-3 fatty acids and vitamins
- Digested liver is high in vitamin 12 and amino acids, it adds to the nutritional value and to the flavour
- N-Butyric acid, a known carp attractor which is naturally organic with a pungent smell
- Available in three sizes in both 1kg and 3kg bags



1KG
 ISOLM94B101000
 ISOLM94B151000
 ISOLM94B181000
 ISOLM94B201000
 3KG
 ISOLM94B153000
 ISOLM94B183000
 ISOLM94B203000



10mm
 15mm
 18mm
 20mm

Ingredients

Corn, Lt94 Fishmeal, Wheat, Full Fat Toasted Soya, Egg Powder, Spices Mix, Birdfood Seeds, Liver Powder, Hydrolysed Animal By-Products, Vegetable Protein Extract, Minerals, Preservatives



ISOLATE RN20 BOILIES

- RN20 is a nut based boilie containing tigernut flour, crushed toasted soya beans, betaine HCL, kelp, spirulina and a wide range of additional proven fish-catching ingredients
- Spirulina is a nutrient-dense food packed full of vitamins, known for lowering stress levels, resulting in a more relaxed state when feeding
- Toasted peanut adds smell and taste attraction
- Tigernut flour, a high energy additive widely known as a top carp bait
- Oyster shell adds texture and a slight 'crunch' mimicking objects that carp pick up off the bottom when feeding
- Available in three sizes in both 1kg and 3kg bags



1KG
 ISORN20B101000
 ISORN20B151000
 ISORN20B181000
 ISORN20B201000
 3KG
 ISORN20B153000
 ISORN20B183000
 ISORN20B203000



10mm
 15mm
 18mm
 20mm
 15mm
 18mm
 20mm

Ingredients

Chickenmeal, Egg Powder, Corngrits, Crushed Toasted Soybeans, Extruded Cornflour, Tigernut Flour, Toasted Peanut Meal, Kelp, Chia Seeds, Rape Seeds, Niger Seeds, Oyster Shells, Yeast, Spray Dried Chickenmeal, Betain, Spirulina, Preservative

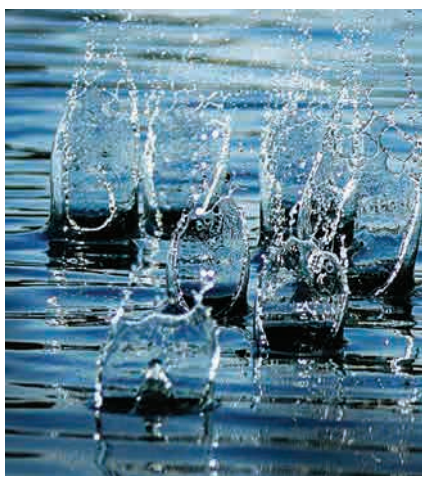

LM94



ISOLATE PELLETS

- High quality pellets with excellent nutritional profile
- Pellets are a convenient choice for anglers who like to keep prepared feed with them at all times
- Ideal for creating a bed of feed, for mixing with other feeds or for use in a PVA bag set-up
- Available in 900g bags in 6 different sizes, ranging from 2mm - 16mm
- 12mm and 16mm pellets come pre-drilled

ISOHPPL02900
 ISOHPPL04900
 ISOHPPL06900
 ISOHPPL08900
 ISOHPPL12900
 ISOHPPL16900

Size	Weight
2mm	900g
4mm	900g
6mm	900g
8mm	900g
12mm	900g
16mm	900g

Ingredients

Fishmeal, SoyafLOUR, Hemoglobin, Feathermeal, Fish Oil, Poultry Oil, Flavouring, Additives: Antioxidants



ISOLATE SYRUP & GLUG

- Liquids derived from the boilie recipe are key to complement your baiting
- Food Syrup and Hookbait Glug can be used to increase hookbait and feed attraction
- The LM94 & RN20 Hookbait Glug comes in a 200ml bottle
- The LM94 & RN20 Food Syrup comes in a 500ml bottle

LM94
 ISOLM94LA500
 ISOLM94HB250
 RN20
 ISORN20LA500
 ISORN20HB250

Syrup	500ml
Glug	200ml
Syrup	500ml
Glug	200ml

Ingredients

LM94 Food Syrup

Glycerin, Hydrolysed Fish Protein, Lt94 Fishmeal, Spices, Birdfood Seeds, Liver Powder, Hydrolysed Animal By-Products, Aroma, Preservatives

LM94 Hookbait Glug

Glycerin, Lt94 Fishmeal, Spices, Birdfood Seeds, Liver Powder, Hydrolysed Animal By-Products

RN20 Food Syrup & Hookbait Glug

Glycerin, Poultry Protein, Tigernut Flour, Toasted Peanut Meal, Kelp, Milled Seeds, Yeast, Betain, Spirulina, Preservatives



TX1 BOILIES

- Packed with quality ingredients and enhanced flavourings to promote quick bites
- The simple, good quality base mix produces an open texture resulting in a high flavour leakage
- Available in 4 popular flavours
- Perfect for day ticket fisheries
- Excellent value for money
- Available in 15mm and 20mm, 1kg and 5kg bags

15MM 1KG
 TX1TNB151000
 TX1SOB151000
 TX1BPB151000
 TX1SBB151000
 15MM 5KG
 TX1TNB155000
 TX1SOB155000
 TX1BPB155000
 TX1SBB155000

Tiger Nut
 Squid
 Banana
 Strawberry

 Tiger Nut
 Squid
 Banana
 Strawberry

20MM 1KG
 20MM 1KG
 TX1TNB201000
 TX1SOB201000
 TX1BPB201000
 TX1SBB201000
 20MM 5KG
 TX1TNB205000
 TX1SOB205000
 TX1BPB205000
 TX1SBB205000

Tiger Nut
 Squid
 Banana
 Strawberry

 Tiger Nut
 Squid
 Banana
 Strawberry

Ingredients

Tiger Nut

Corn, Wheat, Soy Flour, Vegetable Protein Extract, Seeds, Nut Meal, Lecithin, Minerals. Additives: Flavourings, Preservatives.

Squid & Octopus

Corn, Wheat, Soy Flour, Vegetable Protein Extract, Milled Seeds, Crushed Halibut Pellets, Lecithin, Minerals. Additives: Colourant, Flavourings, Preservatives.

Banana & Pineapple

Corn, Wheat, Soy Flour, Vegetable Protein Extract, Milled Seeds, Lecithin, Minerals. Additives: Colourant, Flavourings, Preservatives.

Strawberry

Corn, Wheat, Soy Flour, Vegetable Protein Extract, Milled Seeds, Lecithin, Minerals. Additives: Colourant, Flavourings, Preservatives.



TX1 POP-UPS

- Packed with quality ingredients and enhanced flavourings to promote quick bites
- Pop-up hookbaits give versatility to presentation
- Available in 4 popular flavours
- Available in 12mm and 15mm sizes, in 100g pots

12MM
TX1TNPU12100
TX1SOPU12100
TX1BPPU12100
TX1SBPU12100
15MM
TX1TNPU15100
TX1SOPU15100
TX1BPPU15100
TX1SBPU15100

Ingredients

Tiger Nut

Corn, Wheat, Soy Flour, Vegetable Protein Extract, Seeds, Nut Meal, Lecithin, Minerals. Additives: Flavourings, Preservatives.



Tiger Nut	100g
Squid	100g
Banana	100g
Strawberry	100g

Squid & Octopus

Corn, Wheat, Soy Flour, Vegetable Protein Extract, Milled Seeds, Crushed Halibut Pellets, Lecithin, Minerals. Additives: Colourant, Flavourings, Preservatives.

Banana & Pineapple

Corn, Wheat, Soy Flour, Vegetable Protein Extract, Milled Seeds, Lecithin, Minerals. Additives: Colourant, Flavourings, Preservatives.

Strawberry

Corn, Wheat, Soy Flour, Vegetable Protein Extract, Milled Seeds, Lecithin, Minerals. Additives: Colourant, Flavourings, Preservatives.



TX1 GLUG & FOOD SYRUP

- Packed with quality ingredients and enhanced flavourings to promote quick bites
- The Glugs and Food Syrup can be used to increase hookbait and feed attraction
- Available in 4 popular flavours
- Food Syrup available in 500ml bottles
- Hookbait Glug comes in smaller 200ml bottles

GLUG
TX1TNHB250
TX1SOHB250
TX1BPHB250
TX1SBHB250
SYRUP
TX1TNLA500
TX1SOLA500
TX1BPLA500
TX1SBLA500

Tiger Nut	200ml
Squid	200ml
Banana	200ml
Strawberry	200ml
Tiger Nut	500ml
Squid	500ml
Banana	500ml
Strawberry	500ml

Ingredients

Tiger Nut

Glycerine, Yeast, 1% Tiger Nut

Squid & Octopus

Glycerine, Robin Red (Haiths), Minerals, 1% Squid & Octopus Aroma

Banana & Pineapple

Glycerin, 1% Banana Aroma, 1% pineapple Aroma, EU Approved Colourants

Strawberry

Glycerin, 1% Strawberry Aroma, EU Approved Colourants

SPINNING REEL MAINTENANCE TIPS



1

Tighten drag knob and rinse under low pressure tap water in upright position.



2

Rotate spool and rinse for 15-20 seconds.



3

Use a toothbrush to brush handle area, line roller area and drag knob.



4

Spin reel in fast rotation to channel excess water out.



5

Use a dry cloth to wipe down reel exterior.



6

Use an air duster to spray difficult access area/ joints to clear off excess water.



7

Remove drag knob and wipe off excessive water on spool and rotor area.



8

Screw back drag knob and leave it in a cool dry place.

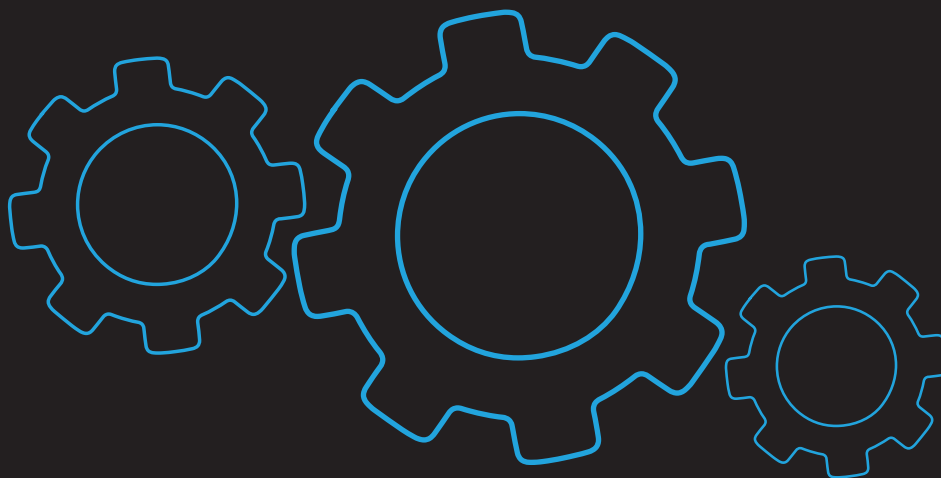

✓ DO.....

- Remove line after deep sea fishing to wash down spool or if intending to keep for long time storage
- Avoid placing your reel on boat side rod holders when boat is traveling to prevent splashes of sea water
- Put 1-2 drops of oil on main shaft, line roller, handle knob bearings, drive gear bearings and screws after 2-3 times usage
- Send for servicing every six months if the reel is being used frequently

✗ DON'T.....

- Rinse your reel when drag knob is loose
- Remove handle when washing
- Use high pressure water to wash down your reel
- Wash your reel in an upside down position
- Soak reel in a bucket of fresh water
- Place your reel under direct sunlight after washing

BAITCASTING REEL MAINTENANCE TIPS



1

Tighten cast control cap and star drag before washing.



2

Rinse well under low pressure water.



3

Rotate spool and rinse for 15-20 seconds.



4

Use a toothbrush to brush handle and star drag area.



5

Use a tube brush to brush reel seat and line guide to ensure salt removal.



6

Spin the reel in fast rotation to channel excess water out.



7

Use a dry cloth to wipe the exterior of the reel.



8

Remove the side cover and wipe off excessive water droplets.



9

Loosen the star drag and leave it to dry in a cool place.

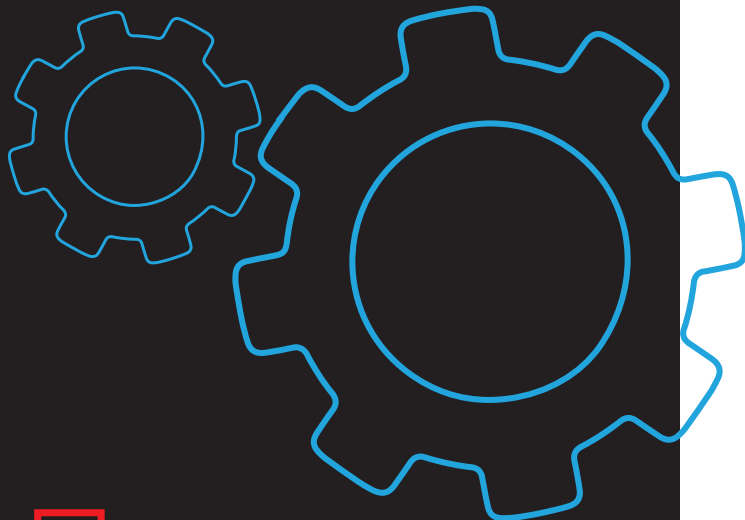

✓ DO.....

- Remove line after deep sea fishing to wash down spool or if intending to keep for long time storage
- Avoid placing your reel on boat side rod holders when boat is traveling to prevent splashes of sea water
- Put 1-2 drops of oil on main shaft, line roller, handle knob bearings, drive gear bearings and screws after 2-3 times usage
- Send for servicing every six months if the reel is being used frequently

✗ DON'T.....

- Loosen cast control and star drag before washing as water might penetrate into the body
- Rinse overhead baitcasting reel on high pressure water
- Dip or soak your reel in fresh water
- Place directly under sunlight after washing
- Wash your reel in upside down position



ELECTRIC REEL MAINTENANCE TIPS



1

Tighten star drag and cast control cap before washing



2

Cover socket with rubber socket cap



3

Quick run through of low pressure water on screen (not more than 3 seconds)



4

Rinse the spool area for removal of remaining salt



5

Engage clutch and pull out 2-3 meter of line while running low pressure water

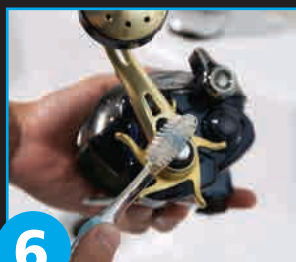

6

Use a toothbrush to brush the handle shank and handle knob area



7

Use a tube brush to brush small accessible area (reel seat, line guide area) to ensure removal of remaining salt



8

Use a wet cloth to wipe down the whole reel to ensure remaining salt and bait is removed



9

Use a dry cloth to wipe down completely



10

Use an air duster to spray difficult access areas to clear off water droplets



11

Loosen star drag and leave in a dry, cool place

✓ DO.....

- Wash your reel with warm water (under 30 degrees Celsius)
- Detergent can be used if stubborn stains can not be removed
- Wash your reel after every trip
- Remove line after deep sea fishing to wash down spool or if intending to keep for long time storage
- Avoid placing your reel on boat side rod holders when boat is traveling to prevent splashes of sea water

✗ DON'T.....

- Wash the screen for too long as water might penetrate
- Wash the reel when the motor is still hot
- Use chemicals like gasoline, kerosene, benzene to wash down reel as it will damage the coating
- Wash your reel when the socket is not covered
- Wash when star drag and cast control is not tightened
- Dip or soak the whole reel into a bucket of fresh water
- Use high pressure water to wash down your electric reel
- Place your reel under direct sunlight after washing

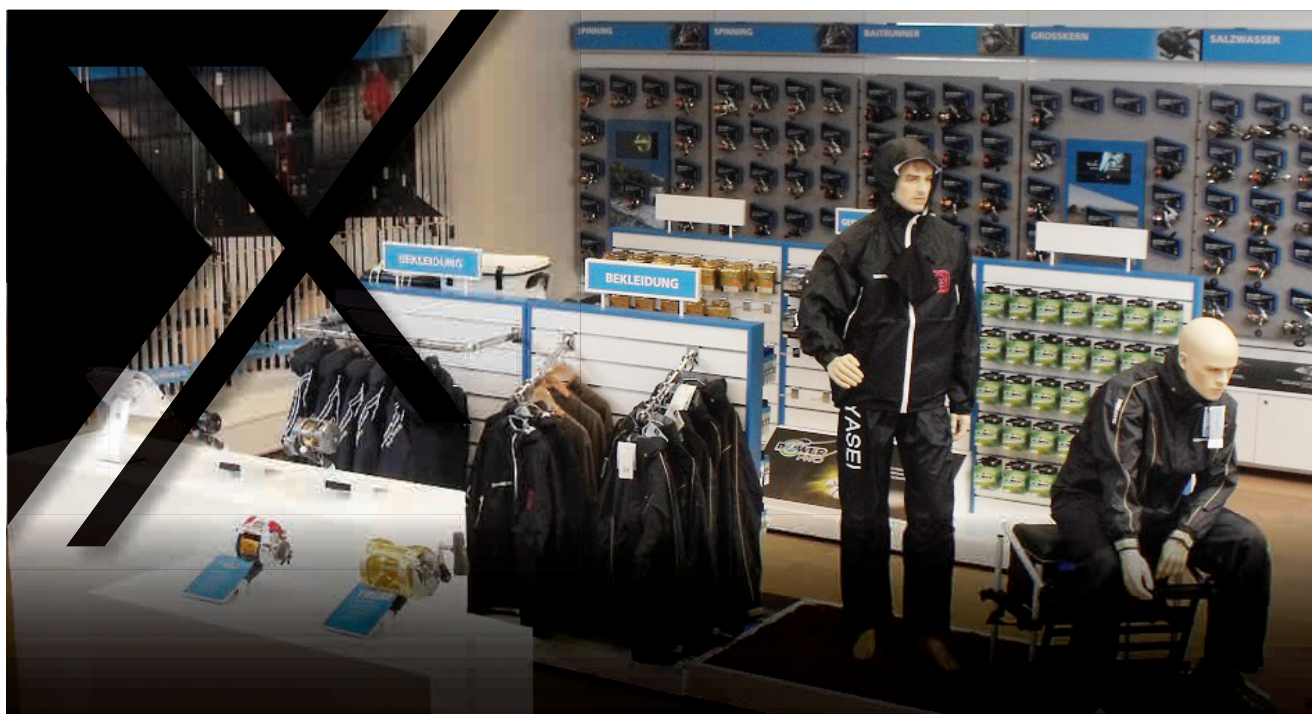

The SHIMANO X-Store focuses on interaction of our products with many benefits and stories of our technologies being explained. With videos and information banners detailing the features of the products it is much easier to compare products and see the wide range of items we have to offer.

We are implementing X-Stores throughout Europe and Africa. So far more than 170 X-Stores have been built in the UK, Italy, Germany, Belgium, the Netherlands, Austria, Russia and South Africa.

BENEFITS

- Touch and feel high-end products
- Making the purchase decisions easier
- Availability of complete range of products
- More information about technologies and products

DEALER PORTAL

OUR DEALER PORTAL INTEGRATES EASY ORDERING, PRODUCT NEWS AND INSPIRATION: MY.SHIMANO-EU.COM

QUICK AND EASY ORDERING

Save time with our helpful features like shopping cart flyout

WIDE RANGE OF PRODUCTS

Up to date inventory and availability information

INTELLIGENT PRODUCT SEARCH

Improved product findability with a powerful search engine

ORDER TOGETHER WITH YOUR CUSTOMER

Switch to a consumer friendly view in a state-of-the-art design

GET INSPIRED

Stay up to speed with the latest product news and insights

ALWAYS AVAILABLE, ON EVERY DEVICE

The same experience on desktop, tablet and mobile

CONTINUOUS IMPROVEMENTS

Together we make the portal and our services better

SHARE YOUR EXPERIENCE

We would love to learn about your experiences. If you have suggestions about how we can improve, please share your ideas with us via our dealer portal



SHIMANO EUROPE B.V.
High Tech Campus 92, 5656 AG Eindhoven, The Netherlands
Tel. +31 (0)40 2612222

SHIMANO BENELUX B.V.
Industrieweg 24, 8071 CT Nunspeet, The Netherlands
Tel. +31 (0)341 272233 · Fax. +31 (0)341 272290

SHIMANO UK FISHING
Unit 2, Elm Court, Copse Drive, Meriden Business Park, Coventry. CV5 9RG
Tel. +44 (0)330 333 4888

SHIMANO ITALY FISHING S.R.L.
S.S. Sempione 197, Pero (MI) 20016, Italy
Tel. +39 (0)238 592 098

SHIMANO GERMANY FISHING GMBH
Dießemer Bruch 114f , 47805 Krefeld, Germany
Tel. +49 (0)2151 55670 · Fax +49 (0)2151 5567-50

SHIMANO FRANCE S.A.S.
Zone Actiparc - 777 Allée Commios, 62052 Saint Laurent Blangy, France
Tél. 03.21.73.25.25 · E-mail: contact-france@shimano-eu.com

SHIMANO IBERIA, SL
Avenida Doctor Severo Ochoa 34, 28100, Alcobendas (Madrid), Spain

SHIMANO NORDIC FISHING
Edsbrogatan 1F, SE-752 28 Uppsala, Sweden
Tel. +46 (0)18 56 16 00

SHIMANO FISHING TURKEY
Shimano Balik Malzemeleri A.S. Eski T. Ozal cd. 17/601 Basaksehir, 34406, Istanbul, Turkey
Tel. +90 212 659 8152 · Fax +90 212 659 8247

SHIMANO POLSKA SP. Z O.O.
ul. Jana Gutenberga 9, Żerniki k/Poznania, 62-023 Gądk
E-mail: spofishing@shimano-eu.com

SHIMANO INC.
3-77 Oimatsu-cho, Sakai Osaka, 590-8577 Japan
Tel. +81 (0)722233467

SHIMANO NORTH AMERICA FISHING INC.
9560 Palmetto Commerce Parkway Ladson, South Carolina, 29456, U.S.A
Tel. +1 949 951 5003 · Fax. +1 949 768 5071

SHIMANO AUSTRALIA FISHING PTY. LTD.
2 Wurrook Circuit, Caringbah, NSW, 2229, Australia
Tel. +61-2-9533-0000 · Fax: +61-2-9524-8822



Follow us on Facebook
Shimano-Fishing
Shimano-Predator
Shimano-Tribal



Follow us on Instagram
@fish_shimano
@shimano_predator
@shimano_tribal



See us on YouTube
www.youtube.com/FishWithShimanoEU
www.youtube.com/ShimanoTribalEU
www.youtube.com/ShimanoPredatorEU



Shimano Europe
is a proud member
of EFTTA

© Shimano 2020 - Pat. & Pat Pending
Lengths and specifications are approximate and may change without prior notice. E. & O.E.

SHIMANO